

EARTHQUAKE AND TSUNAMI COMMUNITY DISASTER CACHE Planning Guide

May 2021



Abstract

A Community Disaster Cache is a stock of supplies designed to support a local population in its response to a disaster. Developing a successful and sustainable Community Disaster Cache involves a four-step planning process: 1) Design, 2) Implementation, 3) Maintenance, and 4) Deployment. Each step serves an important function in the community disaster cache development process.

EARTHQUAKE AND TSUNAMI COMMUNITY DISASTER CACHE Planning Guide

Written and Prepared by:

SUSAN M. GRAVES

Susan M. Graves Consulting, LLC

Prepared for:

OREGON DEPARTMENT OF GEOLOGY AND MINERAL INDUSTRIES

and

OREGON OFFICE OF EMERGENCY MANAGEMENT

Project Manager

DR. JONATHAN ALLAN

Coastal Geomorphologist

Oregon Department of Geology and Mineral
Industries, Newport Field Office

Project Advisory Team

CINAMON MOFFETT

Research Program Manager

Hatfield Marine Science Center, Oregon State
University

MEG REED

Coastal Shores Specialist

Oregon Department of Land Conservation
and Development

DR. ALTHEA RIZZO

Geological Hazards Program Coordinator

Oregon Office of Emergency Management

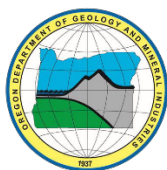

Published May 2021

This publication is a result of tax-supported research and is licensed under a [Creative Commons Attribution-NonCommercial-ShareAlike 4.0 International License](https://creativecommons.org/licenses/by-nc-sa/4.0/). When quoting, paraphrasing, or otherwise referring to this guide, the citation should be: Graves, Susan M. (2021).

Earthquake and Tsunami Community Disaster Cache Planning Guide. Oregon Department of Geology and Mineral Industries, Oregon Office of Emergency Management.

www.oregongeology.org/tsuclearinghouse/resources/pdfs/TsunamiDisasterCachePlanningGuide.pdf

Acknowledgments

Survey and Case Study Participants

Thank you to everyone who participated in our survey or targeted interviews. You informed the concepts in this manual and guided its content. Also, thank you to the case study participants who gave graciously of their time, experience, insights, and disaster cache plans for the benefit of others. Your contributions are a gift.

Project Team

The author wishes to thank the Project Team for their foresight in advocating for the development of a Community Disaster Cache guide. They understand the dire conditions coastal communities will be faced with as a result of a large Cascadia subduction zone earthquake and tsunami. They also recognize the void in guidance for developing community disaster caches and the desire communities have to learn from those who have already developed caches.

I am indebted to Project Manager Dr. Jonathan Allan for his leadership, oversight, and strategic guidance throughout the process of research and writing the *Planning Guide*. His vision, insights, and encouragement as the project grew in scope were invaluable for developing a robust yet practical product.

I am grateful to the Project Advisory Team, Cinamon Moffett, Meg Reed, and Dr. Althea Rizzo for sharing their expertise and for their significant investment of time in reviewing, organizing, and editing the *Planning Guide*. Their contributions have made it a much more readable and valuable tool.

Funding

This project is co-funded under award #NA19NWS4670013 by the National Oceanic and Atmospheric Administration (NOAA) through the National Tsunami Hazard Mitigation Program, and through the National Earthquake Hazards Reduction Program under award #EMS-2019-CA-00009-S01 by the Federal Emergency Management Agency.

Cover Images

Left: Neighborhood Disaster Cache at a Temporary Tsunami Assembly Area.

Right: Inside of a School Disaster Cache.

Both photos courtesy of Susan Graves.

Notice

Many recommendations of specific products, brands, and strategies were made by our case study participants and by others who were interviewed. The inclusion in this guide of a product, brand, strategy, or photographs or drawings that depict a product, brand, or strategy does not indicate an endorsement. Each planning team will need to do their own research and select products and strategies that align with their mission and policies.

This planning guide is intended to assist communities to prepare for earthquakes and tsunamis, and is for information purposes. Opinions, findings, conclusions, or recommendations expressed in this publication do not necessarily reflect the views of the Oregon Department of Geology and Mineral Industries (DOGAMI) or the Oregon Office of Emergency Management (OEM). Neither DOGAMI, OEM, nor any of their employees or contractors, makes any warranty, expressed or implied, nor assumes any legal liability or responsibility for the accuracy, completeness, or usefulness of any information, product, or process included in this publication. Users of information from the publication assume all liability arising from such use.

Table of Contents

INTRODUCTION	8
STEP 1: DESIGN	10
1.A. Project Management	11
1.B. Cache Mission.....	11
1.C. Cache Model.....	14
1.D. Financial Plan	16
STEP 2: IMPLEMENTATION.....	23
2.A. Cache Location	24
2.B. Storage Container	26
2.C. Securing the Cache	33
2.D. Cache Contents	35
STEP 3: MAINTENANCE	40
3.A. Exterior Building.....	41
3.B. Interior Environment	41
3.C. Contents	42
STEP 4: DEPLOYMENT	43
4.A. Operations Plan	43
4.B. Training.....	48
4.C. Replacement Plan	48
CONCLUSION	50
APPENDICES OVERVIEW.....	51

Appendices

APPENDIX A: CACHE SUPPLIES & EQUIPMENT	53
APPENDIX B: CASE STUDIES.....	97
APPENDIX C: TEMPLATES	120
APPENDIX D: SAMPLE AGREEMENTS.....	129
APPENDIX E: INNOVATIVE STRATEGIES	147
APPENDIX F: SAMPLE BUDGETS & SUPPLY LISTS	160
APPENDIX G: OPERATIONS PLANS.....	171
APPENDIX H: DISASTER MORGUE EXAMPLES	203
APPENDIX I: RESOURCES & REFERENCES	219

List of Figures

Figure 1: Overview of the Four-Step Community Disaster Cache Development Planning Process.....	9
Figure 2: The Inside of a Community Disaster Cache.....	9
Figure 3: Planning Worksheet for 'Step 1 Design'	10
Figure 4: Relationship between Cache Models and Specific Partner Responsibilities	16
Figure 5: Example Budget for Basic Needs Cache	17
Figure 6: Example 5-Year Timeline for a Disaster Cache with a Budget of \$10,000	21
Figure 7: Example Completed Cache Design Planning Worksheet	22
Figure 8: Planning Worksheet for 'Step 2 Implementation'	23
Figure 9: Example Cache Locations.....	24
Figure 10: Shipping Container with Wood Floor.....	26
Figure 11: Left: Used 20 ft Container, Right: New 20 ft Container	27
Figure 12: Storage Shed as Place to Store Disaster Cache Supplies	27
Figure 13: Shipping Container on Five Railroad Ties for Leveling and to Protect from Water Pooling	28
Figure 14: Two 20 ft Shipping Containers Elevated on 4x8x16" Solid Block Pavers for Airflow	28
Figure 15: Delivery of Two 20 ft Shipping Containers.....	29
Figure 16: Shade Shed with Fencing	30
Figure 17: Reflective Foil Core Insulation	31
Figure 18: Shipping Container with 12 Built-in Vents	31
Figure 19: Pallets as Base of Container	32
Figure 20: Desiccant Container Bags.....	32
Figure 21: Padlock Configuration with Restricted-Access Lockbox in the Center	33
Figure 22: Tamper-Resistant Lock System by Abus	33
Figure 23: Solar Motion Detection Lights on Fence by a Cache.....	34
Figure 24: Example of Neighborhood Disaster Cache Sign	34
Figure 25: General Categories of Cache Supplies & Equipment.	35
Figure 26: Example of a Cache Layout	36
Figure 27: Pre-made, Adjustable Shelves	37
Figure 28: Example of Stacking on Top of Water Barrels.....	37
Figure 29: Custom Shelving with Stabilizers	38
Figure 30: Example of Completed Cache Implementation Planning Worksheet.....	39
Figure 31: Example of a Cache Inspection Form	40
Figure 32: Example of Tree Branches Leaning Over and On Cache	41
Figure 33: Example of Tipping Problem Inside Cache	42
Figure 34: Example Decision-Tree Depicting When to Open the Community Disaster Cache	44
Figure 35: Example Cache Deployment Organizational Chart	45
Figure 36: Example Cache Deployment & Management Checklist for Operations Plan	46
Figure 37: Example Food Task Card	47
Figure 38: Example Restroom Task Card.....	47
Figure 39: Disaster Cache Training Cycle	48
Figure 40: Deployment & Operations Plan Items to Include in a Disaster Cache.....	49
Figure 41: General Categories of Cache Supplies & Equipment	53
Figure 42: Four Factors for Caching Water	54
Figure 43: Suggested Water Items.....	54

Figure 44: Filling Three 55-gallon Water Barrels..... 55

Figure 45: Water Barrel Dolly..... 56

Figure 46: Two 275-gallon Caged Water Containers 56

Figure 47: FEMA's Food & Water in an Emergency Brochure 58

Figure 48: 20-gal Water Filter Straw, 100-gal Water Filter in Bottle, 100,000-gal Water Filter Straw..... 59

Figure 49: Suggested Shelter Items 60

Figure 50: Pre-made Tarp Shelters can be purchased as a Tube Tent..... 61

Figure 51: Teen CERT Students Assembling a High-capacity Tent..... 62

Figure 52: Suggested Warmth Items..... 66

Figure 53: Mylar Emergency Blanket and 67

Figure 54: Fire Starter Supplies: Flint & Steel, Rechargeable Lighter 68

Figure 55: Suggested Sanitation & Hygiene Supplies..... 69

Figure 56: Temporary Restroom 69

Figure 57: Front Cover of a Sewer Catastrophe Companion 70

Figure 58: Commode Chair 71

Figure 59: Seattle Twin Bucket System 71

Figure 60: Basic Handwashing Station 72

Figure 61: FEMA's Food and Water in an Emergency Brochure 73

Figure 62: Suggested Food & Cooking Items 73

Figure 63: Survival Food Bars with Perforation 75

Figure 64: Front Cover of Pacific Coast Foraging Guide (Hahn & Smith, 2010) 76

Figure 65: Stove Tec Biomass Cookstove 77

Figure 66: Suggested Lighting Items 78

Figure 67: Suggested Power Items..... 79

Figure 68: Portable Power Pack by Cen-Tech 80

Figure 69: NEBO 10,000 mAh Power Bank..... 80

Figure 70: Suggested Communications Items..... 82

Figure 71: GMRS/FRS Walkie Talkies, CB Radio, and NOAA Weather Alert Radio 82

Figure 72: Example of 3 Square Foot Signaling Flag 83

Figure 73: Suggested Medical Items 84

Figure 74: Suggested Search & Rescue Items 86

Figure 75: Non-Spark Emergency Tool..... 87

Figure 76: Suggested Comfort Items..... 88

Figure 77: Suggested Morgue Items 90

Figure 78: Suggested Miscellaneous Items 91

INTRODUCTION

A Community Disaster Cache is a stock of supplies designed to support a local population in its response to a disaster. Disaster caches take many forms and can be designed to accomplish different purposes. Along the Pacific Northwest (PNW) coast, numerous groups have developed disaster caches in various forms and have lessons to share. The goal of this *Planning Guide* is to distill such information to assist communities as they prepare for the next great earthquake and tsunami that will strike the PNW coast of Oregon and Washington.

A Cascadia subduction zone earthquake and accompanying tsunami occurring today would be catastrophic, killing thousands, while displacing tens of thousands of residents and visitors. Many coastal communities are unprepared to deal with the level of destruction and disruption they will experience in the hours to days following the earthquake and tsunami.

A critical component of any initial post-disaster recovery is having disaster caches established in every coastal community. This will enable the public to survive without federal or state aid during the days and weeks after the event. Although there are resources for disaster planning for *individuals*, there are notably fewer resources available to assist *communities* trying to plan at a larger scale. This is because there are many complex social and logistical issues to consider when developing a community disaster cache, including:

- How many people should it serve and for how long?
- How much does it cost and who owns it?
- What do we put in it and how much do we put in it?
- How do we fund it?
- Where can we store it?
- How do we maintain it?

This *Guide* draws upon many collective experiences to help answer these questions and make the process more manageable for those getting started.

WHAT IS INSIDE THE GUIDE?

Developing a successful and sustainable Community Disaster Cache involves a four-step planning process: 1) Design, 2) Implementation, 3) Maintenance, and 4) Deployment (Figure 1).

This *Guide* explores and discusses each of the four steps of the disaster cache development planning process necessary for creating feasible plans tailored to suit a community's unique characteristics (e.g., population, geography). Included in this report is considerable information regarding what supplies and equipment to include in a cache, planning worksheets and templates, examples of written agreements, sample budgets and supply lists, and sample task cards. Featured are eleven case studies where disaster cache projects have been successfully implemented, highlighting what has worked for others.

Community Disaster Cache ◆ Four-Step Planning Process

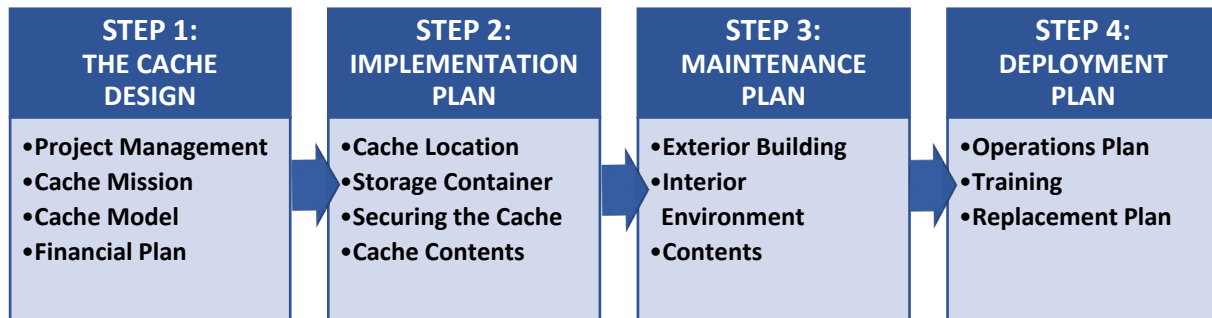

Figure 1: Overview of the Four-Step Community Disaster Cache Development Planning Process

The information contained in this *Guide* can be used to inform the development of new community disaster cache projects or as a tool to evaluate and improve existing disaster caches. Although designed for a response to an earthquake and tsunami, the concepts are transferrable to other hazards.

As planning teams invest the time and energy to systematically work through this four-step planning process they will:

1. Complete the foundational design work necessary to determine their mission, select a cache model that is feasible for their community, and develop a realistic financial plan for implementation of a disaster cache;
2. Make informed decisions about where to locate the cache, how to store and secure it, and what to put in the disaster cache;
3. Establish procedures and agreements to maintain the cache so it will be in working order and ready to deploy when there is an earthquake, tsunami, or other disaster; and,
4. Develop helpful instructions and protocols so survivors can safely and effectively deploy the cache during a disaster and in a high-stress environment when resources are scarce.



*Figure 2: The Inside of a Community Disaster Cache
Photo courtesy of Susan Graves*

Communities that prepare customized disaster caches to meet their unique needs are better equipped to respond to the anticipated immense needs created by a great Cascadia subduction zone earthquake, tsunami, or other disaster.

**STEP 1:
THE CACHE DESIGN**

1.A. Project Management

- 1.A.1. Planning Team
- 1.A.2. Authority

1.B. Cache Mission

- 1.B.1. Hazards & Risks
- 1.B.2. Purpose
- 1.B.3. Target Audience

1.C. Cache Model

- 1.C.1. Cache Model Components
- 1.C.2. Cache Model Examples

1.D. Financial Plan

- 1.D.1. Costs
- 1.D.2. Accounting
- 1.D.3. Funding Strategies
- 1.D.4. Purchasing Strategies
- 1.D.5. Timeline

STEP 1: DESIGN

The first step in a disaster cache planning process is the *Design* phase. The goal here is to define a planning team, identify your mission, make important decisions about the type of cache model that will be established, and determine how it will be funded. This critical first step involves investing significant time to understand the overall needs of the community and gain clarity about these important foundational decisions.

The Design Planning Worksheet (Figure 3) can be used as a checklist to document decisions about each aspect of the design step of your cache project; a full-size version is provided in Appendix C.

It takes discipline and time to work through this process, but it is worth the effort as it lays the foundation for creating a successful and sustainable community disaster cache.

STEP 1: DESIGN PLANNING WORKSHEET				
This is a high-level plan. Details are worked out during Steps 2-4.				
PROJECT MANAGEMENT	PLANNING TEAM			
	AUTHORITY			
MISSION	HAZARDS & RISKS			
	CACHE PURPOSE			
	TARGET AUDIENCE			
CACHE MODEL	CACHE MODEL COMPONENTS			
	CACHE MODEL			
FINANCIAL PLAN	FUNDING			
	TIMELINE	YEAR	ACTIVITY	BUDGET
		1		
		2		
		3		
		4		
5				

Figure 3: Planning Worksheet for 'Step 1 Design'

1.A. Project Management

To start, determine who will lead and coordinate the cache planning effort and identify under whose authority they will operate.

1.A.1. Planning Team

Identify planning team members, their roles and responsibilities, and the scope of the team's activities. For instance, will the team be responsible for developing the cache plan and/or will the team also order supplies and operationalize the cache? Will their role include fundraising? Will the team also lead community outreach and education? Identifying and documenting specific roles and responsibilities of the team and team members will contribute to a healthy and productive team. Integral to the process will be the development of a communication plan that spells out how the team will communicate effectively with each other during the cache planning and development process.

1.A.2. Authority

Identify who will be in charge of the planning team and under whose authority the cache plan will be accepted and approved. Answer questions such as: How does the plan fit with the city or county goals and emergency response plan? Is it acceptable and supported by leadership (e.g., boards, fire, city, or law enforcement)? If you are collaborating with partners (e.g., city or county emergency management, non-profit partners such as Red Cross, churches, schools, service clubs, or others), gaining their buy-in, support, and approval may be critical to the success of the project.

1.B. Cache Mission

Next, identify your disaster cache mission. Think through the hazards and risks to your area, determine the purpose for the cache, and identify your target audience. These are critical first steps for planning out your cache.

1.B.1. Hazards & Risks

Decide on the hazard(s) you would like to address (e.g., earthquake and tsunami), the associated risks of those hazards, and the likely conditions after the event. For example, do you expect to be isolated due to road damage, bridge failure, landslides, or tsunami inundation? Do you anticipate essential services such as water, power, sewer, and communications will not be functional after the event? Will sheltering in homes be unrealistic due to aftershocks?

With these questions in mind, assess the community's capacity to deal with those conditions and articulate any limitations. This will help identify gaps that might be important to address with the cache. It is essential to be clear about the hazards and associated risks the cache will address, as this will guide decisions about the subsequent development and deployment of the cache. For example, if some stakeholders want a cache to help with big winter storms, while others want it to address a catastrophic event, it may be difficult to reach a consensus on many aspects of the cache design.

1.B.2. Purpose

To identify the cache purpose, articulate the problem you want to solve. Clearly state the specific issue(s) you would like to address around the hazards and risks you are concerned about. Here are two examples:

EXAMPLE PURPOSE STATEMENTS

“We are concerned about being displaced from our homes after a large earthquake due to earthquake damage and aftershocks and want to prepare for sheltering outside our homes.”

“Our Region will be cut off into several isolated areas due to earthquake damage and tsunami inundation and we realize there will not be phone or internet services. We want to establish a communication system for each isolated area to be able to communicate with one another.”

Planning teams can further clarify their purpose by honing in on a specific cache focus to narrow down the scope of the cache.

- **Focus:** Determine the focus of the cache by refining the specific details of your purpose. For example, if the identified purpose is to establish disaster caches at Temporary Tsunami Assembly Areas to meet the basic needs of people escaping the tsunami, you will need to figure out what “basic needs” means to the planning team. For some this may reflect minimal needs such as rain ponchos, bottled water, and snack bars for the first 24 hours. Others may desire additional supports such as shelters, cots, blankets, barrels of water, food, a sanitation system, and disaster medical supplies to enable the community to survive for the first two weeks.
- **Scope:** It is also helpful to identify limitations such as what you will not include in the cache and who the cache is not intended to serve. For example, you may determine that the cache is intended only for those evacuating from the tsunami inundation zone, and not for those who live or work outside the tsunami zone. Or, you may decide not to store food in the cache due to limited capacity to rotate and replace expired food, or not to store fuel in the cache due to flammability risks.

Whatever the purpose and associated focus and scope, make sure they are identified and communicated clearly to the cache planning team and partners. This will help the planning team be unified as they work to identify needed supplies and equipment that will be stored in the cache.

Once the overarching purpose has been established, it is necessary to identify your target audience.

1.B.3. Target Audience

To determine the segment of the population the cache is designed to serve, answer these four questions:

1. What geographic area will the cache support? Create a map to support the planning team's decision-making process.
2. Who are the intended users of the cache within that geographic area? Are they individual households, a neighborhood, or a specific group of people (e.g., a church, business, school, or hospital)? Evacuees from the tsunami inundation zone? A search & rescue team, amateur radio team, or disaster medical team?
3. Based on the geographic area and intended users, how many people do you expect the cache will need to support, and for how long?
4. What are the demographics of your target audience? Are there unique needs or capabilities to take into consideration for cache planning purposes, such as:
 - Cultural and religious considerations,
 - Language barriers,
 - Dietary requirements, food restrictions, or allergies,
 - Mobility limitations or medical needs,
 - Age (e.g., elderly, infants, unaccompanied minors),
 - Tourists, residents, workers,
 - Pets and other animals,
 - Special skills: Are skilled personnel (e.g., having a medical, communications, or construction background) located in the geographic area who may be able to assist with post-disaster recovery, including search and rescue operations?

Keep the target audience in mind during every phase of the disaster cache planning process. This will help identify the needs of the community that will be served by a disaster cache. It will also help determine what supplies and equipment are most appropriate and the quantity of supplies needed. An example disaster cache mission is provided below.

EXAMPLE CACHE MISSION

Hazards/Risks: Earthquake & Tsunami; Essential utilities such as power, water, sewer, and communications are not functional.

Purpose: Provide options for clean drinking water for residents.

Focus/Scope: Caches will be established in three neighborhoods. We will store 2-days of water, water heater siphon kits, instructions for safely collecting and purifying water, and individual water filter straws. The cache is designed to meet 2-days of immediate water needs and then empower residents to take care of their own water needs. The cache will not contain community water filtration systems.

Target Audience: Three Residential neighborhoods of single-family homes, 1500 people (mixed ages), languages (English and Spanish), pets (dogs & cats).

TIP: MOTIVATION

Be cognizant of your motivation for developing a cache. What is driving this? Why now? Is there a funding opportunity that is time sensitive? Is there a critical mass or team that is passionate about it? Was there a recent disaster elsewhere that is creating a window of opportunity to get this done? Is there public or governmental pressure to do it? These factors may present opportunities and challenges. Awareness of motivation can aid in the planning process, decision-making, and success.

1.C. Cache Model

Identify your cache model. There are many different components of a disaster cache model with potential partnership opportunities related to its *location, funding, ownership, and maintenance*. The specifics of each component can be mixed and matched to create a model that aligns with a planning team's identified mission and accounts for its unique social and physical circumstances.

1.C.1. Cache Model Components

To determine your cache model, keep your cache mission in mind and think about the following key questions:

- **Where will the cache be stored?** Decide *where* the cache supplies will be located. This could be at a centralized location such as a temporary tsunami assembly area, school, or neighborhood, or the supplies may be dispersed to a specific group or to individual homes for storage.
- **Who buys the cache storage container and supplies?** Decide who will *buy* the supplies and/or container(s) the supplies are stored in. This could be individuals, groups, or organizations, or a partnership between them.
- **Who owns the cache storage container and supplies?** Decide who will *own* the supplies and/or container(s) the supplies are stored in once they have been purchased. As with the previous question, this could reflect individuals, groups, organizations, or partnerships.
- **Who maintains the cache storage container and supplies?** Decide who will *maintain* (i.e., take care of) the supplies and/or container(s) the supplies are stored in once they have been purchased. This again could be individuals, groups, organizations, or partnerships.

In answering each of these questions, it will become apparent that a variety of cache models with various partnership options could be adopted. Partners in this context can therefore be

any combination of: 1) *organizations* (such as fire departments, cities, counties, and their associated volunteer groups); or 2) *specific groups* (such as neighborhoods, schools, hospitals, churches, boys & girls clubs, camps, or businesses); or 3) *individual households*. Furthermore, partnerships could reflect a variety of forms: a) pooled, where all partners work together to share the financial burden in developing, owning, and maintaining the cache; or b) specific, where each partner buys, owns, and maintains different components of the cache, such as the storage container and/or contents.

Where partnerships are involved, it is critical to have a written agreement that spells out the responsibilities of each partner; sample written agreements are provided in Appendix D.

Having considered each of these questions, the collective answers will help define the most ideal cache model to fit your community needs.

1.C.2. Cache Model Examples

Listed below are three examples of cache models that communities have developed to accomplish their mission. Each is showcased in detail in the case studies found in Appendix B. The cache model identifies *who* is responsible for various cache *components* (location, funding, ownership, and maintenance) and reflects a unique implementation strategy. Figure 4 demonstrates the relationship between the partners responsibilities for the cache components and the cache model. Teams can select one of the existing models or create their own.

- **Standalone Disaster Cache:** In this model, the complete disaster cache (storage container and supplies) is kept at a designated location for use by an organization or specific group of people. It may be funded, owned, and maintained by a single entity or by multiple groups. This is the most common type of community disaster cache. There are several case studies in Appendix B representing this model, including *Coastal Cache, Coos Bay, Eagles Nest, Eastside CERT, Joyce, Lincoln County Schools, and Safe Haven Hill*.
- **Storage for Residents' Supplies:** In this model, an organization provides a secure place (a location and storage building) in which residents store their own disaster supplies in barrels, totes, or buckets. Residents can access their supplies at designated times throughout the year. There may be an annual storage fee. See the *Gearhart* case study in Appendix B.
- **Dispersed Supplies:** In this model, an organization provides the supplies for others to store. It can be done in two ways:
 - ✓ **Conveyed to a Specific Group:** An organization provides the cache supplies to a specific group that meets certain criteria. The group receives the supplies, provides a secure location for them, and owns and maintains them. See the *Tillamook County* and *Berkeley* case studies in Appendix B.
 - ✓ **Stored in Residents' Homes:** An organization fills barrels with disaster supplies and stores them in homes of individual residents that are outside the tsunami inundation zone. The organization owns and maintains the barrels of supplies, and a written

agreement outlines the residents’ responsibility to store and deploy the barrels for community use after an earthquake. See *Seaside Case Study* in Appendix B.

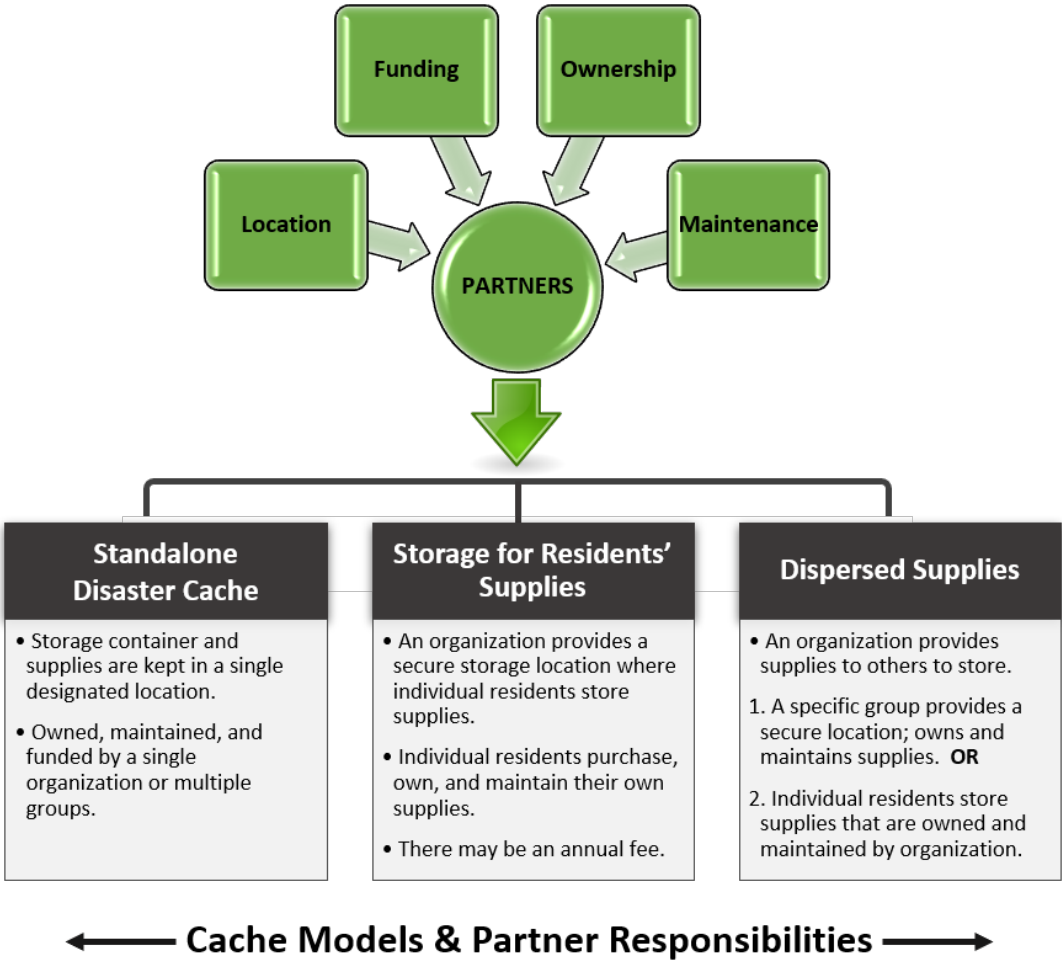

Figure 4: Relationship between Cache Models and Specific Partner Responsibilities involving the Location, Funding, Ownership, and Maintenance of the Community Disaster Cache

Depending on the model selected, there may be different levels of community outreach necessary to accomplish the goals associated with the cache model. This manual does not address community outreach measures, but several existing resources for consideration are listed in Appendix I. Develop a community outreach plan if needed and determine if outreach will be part of the disaster cache planning team’s role.

1.D. Financial Plan

Having identified the mission and cache model, planning teams will need to establish a financial plan. Figuring out how to fund a disaster cache project can be challenging. Planning teams will need to determine all costs associated with the project, how to account for monies received and expended, and where funding will come from to pay for the cache. As indicated earlier, the

type of cache model and related partnerships will directly impact the development of a financial plan, which will further help guide development of the cache budget and timeline.

1.D.1. Costs

Identify all costs associated with the cache including the storage building, ground preparation, weatherization (if needed), security, shelving, storage bins, supplies and equipment (Figure 5). All of these considerations are discussed in detail in *Step 2: Implementation*.

EXAMPLE BUDGET FOR BASIC NEEDS CACHE SUPPORTING 300 PEOPLE					
ITEM	DESCRIPTION	QTY	PRICE	TOTAL	NOTES
CACHE STORAGE BUILDING					
Steel Shipping Container	20' new, includes delivery	1	\$ 3,700.00	\$ 3,700.00	
Ground Prep & Locks	Railroad Ties, Gravel, Padlock	1	\$ 300.00	\$ 300.00	Labor donated
2" Foam Board Insulation	4ft x 8ft sheets	19	\$ 40.00	\$ 760.00	Labor donated
Liquid Nails for Insulation		1	\$ 37.00	\$ 37.00	
SHELTER					
Tarps	10' x 20' , Heavy Duty	300	\$ 10.00	\$ 3,000.00	1 Tarp per person
Rope	25' Poly	300	\$ 1.00	\$ 300.00	25' of rope per person
Mylar Blankets	52" x 84"	300	\$ 0.40	\$ 120.00	1 Mylar blanket per person
WATER					
55-gallon Barrels	Includes purifier, pump & wrench	12	\$ 120.00	\$ 1,440.00	2.2 gallons per person (4 days @ 1/2gal per day)
Plastic Disposable Cups	Sturdy, 12 ounce, 240 cups	3	\$ 20.00	\$ 60.00	2 cups per person
RESTROOMS					
Toilet Buckets	5-gallon bucket with toilet seat lid	8	\$ 18.00	\$ 144.00	2 buckets per tent (1-each POO & PEE)
Pop-up Privacy Tents		4	\$ 30.00	\$ 120.00	75 people per makeshift bathroom
Sand Buckets & handshovels	8 2-3 gallon buckets & shovels	8	\$ 1.00	\$ 8.00	Material to cover poop
Plastic Bag Toilet Liners	Compostable Trash Bags 100 count	1	\$ 11.00	\$ 11.00	
TOTAL				\$ 10,000.00	

Figure 5: Example Budget for Basic Needs Cache Focused on Basic Shelter, Water & Sanitation for 300 People (prices reflect costs as of January 2021). Additional Sample Budgets Provided in Appendix F.

1.D.2. Accounting

Financial accountability is essential. Planning teams will need to establish a system for how monies will be received, expended, and tracked for the different aspects of the cache. The sooner this is established and formalized, the more organized this vital part of the cache process will be. It also reduces the possibility of mismanaged funds, misunderstandings about how to spend monies, misplacement of donated funds, or other potential financial problems. Having this clearly established will also elicit confidence in a team's ability to responsibly manage budgeted or gifted funds.

TIP: NON-PROFITS

Some cache planning teams will partner with an established non-profit to receive, track, and distribute funds. Using an existing structure reduces the amount of time a team has to invest to set up an accounting system for the cache from scratch. It can also empower the team to pursue certain grants that are only available to non-profits. Furthermore, it can provide an incentive and mechanism for people to make donations to the cache project with potential tax benefits.

1.D.3. Funding Strategies

Determine how to pay for the cache storage building and supplies. There are several funding strategies to consider.

- **Partnerships:** If the cache model involves having a storage place for individual residents to store their own disaster supplies, this shared cost approach can become part of the funding strategy. If multiple partners are involved in a standalone disaster cache project, determine what each partner can contribute. Some partners may be able to contribute money, while others might donate labor or materials (e.g., ground preparation or container weatherization). Still others may contribute the time and skill involved in ordering supplies, record-keeping, and report writing. These kinds of partnership contributions can also be leveraged as justification and matching funds for grant opportunities.
- **Budgeted funds:** Determine if your organization and partners will designate a certain amount of money in their annual budget toward development of the disaster cache. Disaster cache plans that are thoughtful, realistic, and strategic are more likely to receive support from a local community and/or from other organizations. Planning teams should think about their target population as potential donors. Neighborhood homeowner's associations, schools, churches, hospitals, cities, fire districts, etc., all have annual budgets. If the cache project is mutually beneficial and designed to serve their populations, such groups may be willing to contribute to the overall goals of the project. If the cache is going to serve visitors from a group of lodging facilities, consider forming a partnership with those businesses and work to get their buy-in and regularly budgeted funds for the project. Some businesses budget monies for end-of-year giving opportunities. Additionally, sometimes agencies have extra monies near the end of a fiscal year that could be earmarked for a particular item for the disaster cache.

TIP: BUDGETS & TIMING

Be thoughtful about fiscal years of the partners you might approach to assist with funding. Budget planning and commitments often occur many months before a budget is even adopted. Build relationships, raise awareness about mutual benefits, and develop buy-in well in advance of a budget planning season.

- **Donations:** There are pros and cons to receiving donated money or items. Financial donations can be a particularly helpful approach for purchasing supplies for a cache. If accepting donated items, it is important to be very clear about what will be received and especially who will own it. Make sure gifts do not come with strings attached or expectations about how and when they will be deployed. If the planning team has a specific list of items identified as needs, it may be important to ensure that only those exact items on the list can be donated; or that they can only accept financial donations, which allows the team to make the necessary purchases. This will ensure the right supplies are purchased and that they meet the goals for the cache. If a project relies on donations, it may be necessary to have a more general list of desired items. Customize this part of a plan according to the mission and capabilities of the team.
- **Grants:** Grants are gifts of money to be used for a designated purpose. After working through Steps 1-4 to develop a disaster cache plan, the planning team will be better equipped to apply for grants to support implementation of the plan. Grantors want to know that there is a real need, that there is an effective, deliberate plan to meet that need, and that you will responsibly expend the monies awarded to accomplish project goals. Matching grants can be a great way to leverage limited funds and incentivize giving opportunities for others. A matching grant will require that the organization applying for the grant contribute a portion of funds and/or labor ('in-kind') towards the overall cost of the grant project. Be sure to keep track of all funding sources, including hours and hourly rates of staff and/or volunteer time invested in planning.

TIP: FOLLOW-UP

Grants will require reports accounting for how the monies are spent in alignment with the promised grant activities. Complete the reports on time. Include photos, offerings of thanks and appreciation, and public recognition where appropriate. These are thoughtful and strategic gestures for acknowledging partnerships, donations, and contributions.

- **Service Clubs & Community Organizations:** Service clubs such as Elks, Rotary, Kiwanis, Lions, and Chamber of Commerce organizations can be great partners for disaster cache

development and funding. Sometimes these clubs will contribute financially or take on a certain aspect of the cache development. For example, one might decide to provide the rain ponchos and Mylar blankets, another might spearhead a fundraiser, while still others might let the planning team speak at a club meeting so that individuals can donate or contribute to the project.

- **Fundraisers:** For groups that can invest time and energy, fundraisers can be another way to raise money for a cache project. Fundraisers also serve an added benefit of fostering community awareness and building buy-in for the project. Some groups will couple their fundraisers with a larger preparedness campaign to reach more people and accomplish multiple objectives with the same effort.

1.D.4. Purchasing Strategies

Explore different procurement strategies to get the best prices on the items on the cache list.

- **Shop local:** You may be able to get a reduced rate by purchasing from local merchants who have a stake in their community's preparedness. Some local retailers may even donate to the cache; this represents a great opportunity for collaboration in the project and positive press.
- **Leverage partnerships:** Determine if you can order supplies through a partner agency and use their government rate. (Note: government rates are not always the best prices available.) Consider checking with the local emergency manager or fire department to access supplies at a substantial discount from state, federal, or military surplus organizations.
- **Purchase in bulk and look for discounts:** Partner with others who are developing caches to purchase in bulk at reduced rates. Some supplies may be less expensive at end of season close-out sales.

1.D.5. Timeline

Establish a project timeline for developing the cache. The timeline should include sufficient time for planning, community outreach (if specified), setting up the cache storage building(s), and filling the cache with supplies and equipment. Knowing the expected costs and having a funding plan in place can help guide development of an implementation timeline. Any plan timeline will be dependent on the scope of the project, availability of financial resources, and the time required to develop the cache.

- **Single Cache:** If developing a single standalone disaster cache and funding is readily available, the team may decide to use an ambitious 1-year cache development plan to complete the required task. Conversely, that single cache may take several years to complete if budgets require funding to be allocated over time. Both strategies work. Figure 6 is an example of a 5-year timeline for a single cache focused on basic shelter, water, and sanitation support for 300 people. The same cache project could be compressed into one year if funds and personnel time allowed.

EXAMPLE: 5-YEAR CACHE TIMELINE		
Total Budget \$10,000 (\$2,000 per year)		
YEAR	ACTIVITY	BUDGET
1	Develop Plan	Reserve \$2,000
2	Prepare Ground & Setup Cache Building (steel shipping container)	\$2,000
3	Finish Container Prep & Order Phase 1 Cache Supplies	\$2,000
4	Order Phase 2 Cache Supplies	\$2,000
5	Order Phase 3 Cache Supplies	\$2,000

Figure 6: Example 5-Year Timeline for a Disaster Cache with a Budget of \$10,000

- Multiple Caches:** If developing a network of caches for a region, a 5- or 10-year timeline may be more appropriate. In that case, the team could initially start with one or two caches and expand accordingly over time. Conversely, the team could start by identifying all potential cache locations and establish the cache storage buildings for all caches over the first several years. Supplies to fill the caches may then be subsequently purchased in later years.

Some teams establish a prioritized list of supplies to purchase over time but remain flexible regarding the order of the purchases to account for situations affecting the cost. That could include market availability, discounted pricing, grants that support purchasing specific items, donations of items, and product availability in state or federal surplus programs.

Having a plan and timeline in writing will help keep everyone on track and avoid straying from the mission of the community disaster cache. It will also help with sustainability as team members move in and out of the local area and as roles change. As is typical with project timelines, sometimes circumstances change and plans need adjustment. Try to stick with the projected timeline but be willing to pivot if it makes sense and aligns with the mission and goals established for the disaster cache.

Step 1 Summary

Working through Step 1 and making these important decisions about cache design will result in a high-level cache design plan (Figure 7). This will lay the groundwork for proceeding to the next step in the cache planning process involving critical decisions about cache implementation.

STEP 1: DESIGN PLANNING WORKSHEET																							
EXAMPLE: TSUNAMI ASSEMBLY AREA CACHE PROJECT																							
PROJECT MANAGEMENT	PLANNING TEAM	A Cache Planning Team comprised of city and fire district personnel will be established to jointly plan, implement, and manage the disaster cache project. A leader will be appointed.																					
	AUTHORITY	The City Manager and Fire Chief will ensure the plan is aligned with agency goals and will approve the plan. City Council and Fire Board approval is not required.																					
MISSION	HAZARDS & RISKS	The cache is for a response to a Cascadia subduction zone earthquake and tsunami hazard. We expect massive infrastructure damage including all utilities, many roads and bridges destroyed, and homes uninhabitable. People will escape the tsunami with very little supplies.																					
	CACHE PURPOSE	Purpose: To meet the immediate, short-term, basic survival needs of people evacuating from the tsunami inundation zone after a large earthquake. Focus & Scope: Provide for minimal basic needs for up to 72 hours (congregate shelter, water, toilets, and first aid). We will not store food. We will not store people’s personal supplies.																					
	TARGET POPULATION	Residents, workers, visitors evacuating from the tsunami zone and assembling at any of the four designated Temporary Tsunami Assembly Areas in our region.																					
CACHE MODEL	MODEL COMPONENTS	Location: Caches will be established at or near our four Temporary Tsunami Assembly Areas. Specific locations are to be determined. Ownership & Maintenance: The City will own, insure, and maintain the 2 caches in the city limits. The Fire District will own, insure, and maintain the 2 caches in the unincorporated areas. A written agreement will be in place.																					
	CACHE MODEL SELECTED	Standalone Disaster Cache																					
FINANCIAL PLAN	FUNDING	Joint funding between city and fire district. The goal is to collectively invest \$60,000 over a six-year period using budgeted agency funds, grants, and donations. The Cache Planning Team can draw upon agency resources to assist with labor-related aspects of the project where feasible. The City will manage all project funds following its established accounting system processes.																					
	TIMELINE	<table border="1"> <thead> <tr> <th>YEAR</th> <th>ACTIVITY</th> <th>BUDGET</th> </tr> </thead> <tbody> <tr> <td>1</td> <td>Develop Plan. Identify 4 cache sites. Write agreements. Raise funds.</td> <td>\$10,000</td> </tr> <tr> <td>2</td> <td>Order & install 1st and 2nd Cache building (prepare interior & exterior)</td> <td>\$10,000</td> </tr> <tr> <td>3</td> <td>Order & install 3rd & 4th Cache Structure (prepare interior & exterior)</td> <td>\$10,000</td> </tr> <tr> <td>4</td> <td>Order & distribute first installment of supplies into each cache</td> <td>\$10,000</td> </tr> <tr> <td>5</td> <td>Order & distribute second installment of supplies into each cache</td> <td>\$10,000</td> </tr> <tr> <td>6</td> <td>Order & distribute third installment of supplies into each cache</td> <td>\$10,000</td> </tr> </tbody> </table>	YEAR	ACTIVITY	BUDGET	1	Develop Plan. Identify 4 cache sites. Write agreements. Raise funds.	\$10,000	2	Order & install 1 st and 2 nd Cache building (prepare interior & exterior)	\$10,000	3	Order & install 3 rd & 4 th Cache Structure (prepare interior & exterior)	\$10,000	4	Order & distribute first installment of supplies into each cache	\$10,000	5	Order & distribute second installment of supplies into each cache	\$10,000	6	Order & distribute third installment of supplies into each cache	\$10,000
YEAR	ACTIVITY	BUDGET																					
1	Develop Plan. Identify 4 cache sites. Write agreements. Raise funds.	\$10,000																					
2	Order & install 1 st and 2 nd Cache building (prepare interior & exterior)	\$10,000																					
3	Order & install 3 rd & 4 th Cache Structure (prepare interior & exterior)	\$10,000																					
4	Order & distribute first installment of supplies into each cache	\$10,000																					
5	Order & distribute second installment of supplies into each cache	\$10,000																					
6	Order & distribute third installment of supplies into each cache	\$10,000																					

Figure 7: Example Completed Cache Design Planning Worksheet

**STEP 2:
IMPLEMENTATION PLAN**

2.A. Cache Location

- 2.A.1. Mission Alignment
- 2.A.2. Land Use Regulations
- 2.A.3. Hazards & Access
- 2.A.4. Written Agreement

2.B. Storage Container

- 2.B.1. Type & Size of Building
- 2.B.2. Site Prep Strategies
- 2.B.3. Building Prep Strategies

2.C. Securing the Cache

- 2.C.1. Security
- 2.C.2. Access Control
- 2.C.3. Signage

2.D. Cache Contents

- 2.D.1. Supplies & Equipment
- 2.D.2. Quantities
- 2.D.3. Storage & Organization

STEP 2: IMPLEMENTATION

Having completed the design process, the next step in developing an earthquake and tsunami community disaster cache is creating an *Implementation Plan* to guide the development of the physical cache.

Implementation will vary depending on the specific requirements of the cache model selected. However, it generally involves some iteration of preparing the location for the cache, procuring and preparing the actual cache storage building or structure, securing the cache, and filling the cache with supplies and equipment.

This can be the most rewarding part of the project as the plan becomes tangible and the disaster cache is realized.

The Implementation Planning Worksheet (Figure 8) can be used as a checklist to document decisions about each aspect of the Implementation Plan; a full-size version is provided in Appendix C.

STEP 2: IMPLEMENTATION PLANNING WORKSHEET		
CACHE LOCATION	MISSION ALIGNMENT	
	LAND USE REGULATIONS	
	HAZARDS & ACCESS	
	WRITTEN AGREEMENT	
STORAGE CONTAINER	TYPE & SIZE OF BUILDING	
	SITE PREP	
	BUILDING PREP	
SECURING THE CACHE	SECURITY	
	ACCESS CONTROL	
	SIGNAGE	
CACHE CONTENTS	SUPPLIES & EQUIPMENT	
	QUANTITIES	
	STORAGE & ORGANIZATION	

Figure 8: Planning Worksheet for 'Step 2 Implementation'

2.A. Cache Location

Determining where to locate a disaster cache can be one of the most challenging parts of the planning process.

2.A.1. Mission Alignment

Revisit the cache mission and model to help guide the parameters of where to locate caches (Figure 9). For example, if the plan is to establish a network of caches for a city's temporary tsunami assembly areas, it will be necessary to find locations at or near those assembly areas. If developing a cache for a specific group's use (e.g., a school, neighborhood, business, or hospital), then work to find a location in close proximity to the group so that the cache is accessible to them after an earthquake and/or tsunami.

A disaster cache plan may require identifying different regions or zones where caches will be placed over time, either in residents' homes or at dedicated cache locations. If so, work out a plan to establish locations that are accessible across the jurisdiction based on the target audience and the expected number of people in each geographic area.

POTENTIAL CACHE LOCATIONS
Fire Department
School or College
Park, Athletic Facility
City or County Property
Campground
Community Center
Temporary Tsunami Assembly Area
City or County Public Works
Public Parking Lot
Community Garden
Boys & Girls Club
Church or House of Worship
Neighborhood RV or Boat Storage Lot
Hospital or Health Care Parking Area
Lodging Facility
Apartment Complex
Inside Residents' Homes/Garages
Utility Providers
Businesses
Storage Units

Figure 9: Example Cache Locations

2.A.2. Land Use Regulations

Having identified potential cache locations, the next step is to check with your city or county planning department, or neighborhood association to see if there are any regulations around locating the type of cache storage building or structure being considered. Check to see if there are differences between locating a cache on private property versus publicly owned property. Sometimes there are regulations about the height of a building or its visibility from the street. Other regulations may exist for residential zones. Find out what is allowable and if any permits are required. Having this information will help guide the decision-making process about the location, site preparation, and type of storage feasible for the cache project.

2.A.3. Hazards & Access

As you narrow down decisions about where to locate the cache, examine the known or anticipated hazards at each site location. Investigate these questions:

1. Is the cache location out of the tsunami inundation zone?
2. How accessible is the site likely to be after a disaster?

3. Is it in a potentially geological unstable area subject to landslides or ground liquefaction?
4. Are there structures, trees, or other hazards likely to fall on the cache?
5. Is the location susceptible to crime, graffiti, or break-ins?
6. If the cache will store large quantities of water, is there adequate access for filling water barrels?
7. If the cache requires electricity, is that realistic for the chosen location?

Each of these questions should be carefully evaluated when selecting a location for an earthquake and tsunami community disaster cache, and will help determine potential security, site preparation, or maintenance requirements. Furthermore, exploring such questions will better guide cache placement decisions so that the cache is accessible and functional during a disaster.

TIP: PARTNERS

There can be many barriers to finding an acceptable location for a cache. This highlights the importance of developing strong community partnerships and buy-in for the disaster cache project. As partners get on board and understand the benefits, they may be willing to designate a small portion of their property for the cache.

2.A.4. Written Agreement

If the sponsoring organization does not own the land where it plans to place the cache, it is essential to have a written agreement in place with the property owner identifying:

- Who will own, insure, and maintain the cache storage building or container and the contents?
- How the cache will be secured, and when and how often the cache owner can access the cache.
- Any fees or time restrictions associated with use of the land, and what to do if the cache needs to be relocated.
- Acknowledgement of any necessary permits or easements.
- If the hosting property owner has any rights to access the cache and under what circumstances.
- Agreement about the type, size, and physical characteristics of the cache storage building, and if there will be any associated signage or publicity about its purpose or location.

Examples of written agreements are located in Appendix D.

2.B. Storage Container

Figuring out the details of the actual storage container or building that will hold the cache supplies can be complex. Questions concerning the type, size of storage facility, any needed site preparation, and how to prepare the building to hold the supplies will need to be carefully evaluated. Various strategies for consideration are discussed here.

2.B.1. Type & Size of Storage Container or Building

Examine the location selected and how much space is available for a cache storage building. Here are some building types and factors to consider:

- Shipping Containers:** Steel shipping containers, sometimes referred to as Conex boxes, are commonly used storage repositories for disaster caches. They are generally readily available and easy to purchase, no assembly is required, and they are easy to secure. They are designed to have a tight seal and are usually considered to be wind, watertight, and rodent proof. Steel shipping containers typically have wood flooring (Figure 10) and several vents for air flow. However, not all shipping containers are equal. Check with the vendor to determine exactly what they have to offer. Here are some additional factors to consider:



Figure 10: Shipping Container with Wood Floor

Photo courtesy of Susan Graves

- Size:** The standard size for steel shipping containers is either 20 or 40 ft long by 8 ft wide by 8.5 ft high. Less common sizes are 10 ft and 45 ft long, and some are taller. The price of a 40 ft container is more economical in terms of square footage but it can be difficult to move once delivered, requiring specialized equipment. As time passes and circumstances change, disaster caches often have to be moved to new locations. Equipment to move the 20 ft containers may be easier to obtain in some areas.
- Used vs. New:** Used shipping containers cost much less but can have problems and limitations. Used containers may have rust, patched holes, dents, or misaligned door handles, hinges, and gears making it difficult to open and close the doors, which may compromise the seal of the container (Figure 11, left photo). Used containers require a greater degree of ongoing maintenance. Conversely, new containers are more expensive but are structurally sound, have a watertight seal, are more visually

appealing, with hinges, gears, and door mechanisms that are easy to manage (Figure 11, right photo). New containers are not “new”; they are called “new one-way” or “single-trip” containers. This typically means that they have made one trip across the ocean to deliver goods and then are sold.



Figure 11: Left: Used 20 ft Container, Right: New 20 ft Container

Photos courtesy of Susan Graves

- **Other Options:** Other storage options include freestanding storage buildings such as metal, resin (Figure 12), or wood sheds, or mobile storage trailers on wheels. While these options are sometimes less expensive than new shipping containers, they have some drawbacks. They often do not have a tight seal, allowing access for rodents and making them more difficult to secure. They also require greater maintenance. Depending on the chosen cache model, there may be other options. If a dispersed cache model is adopted, it may be possible to store the cache supplies inside a garage or in neighborhood homes. Alternatively, a heated self-storage unit could be rented and used to house the cache of supplies; the latter will require an ongoing financial commitment.



Figure 12: Storage Shed as Place to Store Disaster Cache Supplies

Photo courtesy of Susan Graves

2.B.2. Site Prep Strategies

It is important to have the site completely ready before the shipping container or storage building arrives. Examine the surface to determine the type of ground preparation needed. Different types of preparation may be required for pavement, grass, sand, soil, or gravel surfaces. Think about water pooling (Figure 13), the potential for flooding, and if the storage building needs to be raised. Determine if soil settling is a factor and the associated risk of tipping. It may be necessary to compact the ground and establish a layer of gravel on which to place the structure. Another strategy involves using poured concrete piers, solid block pavers (Figure 14), or pressure treated 4 x 4 or 8 x 8 ft boards to place the container on a raised surface, which can help with air flow and protect against ground-water pooling.



Figure 13: Shipping Container on Five Railroad Ties for Leveling and to Protect from Water Pooling
Photo courtesy of Susan Graves



Figure 14: Two 20 ft Shipping Containers Elevated on 4x8x16" Solid Block Pavers for Airflow
Photo courtesy of Susan Graves

CAUTION - WEIGHT

When planning for stabilizing the storage container or building, consider the weight of the items planned for storage in the cache and how much their combined weight will affect the entire structure. If you plan to store a significant amount of water, know that water is heavy and can cause the container to tip if not balanced properly. Some large tents can also be extremely heavy when stored and can cause the container to tip if improperly stacked. This can make it difficult to open and close the storage container and cause damage to items that fall over.

- **Placement:** If more than one shipping container is to be established at the same location and there is sufficient space, it may be feasible to strategically locate the containers in such a way that it creates additional shelter. For example, one planning team placed two 20 ft shipping containers end to end, opening toward each other. During a disaster, they plan to place a tarp between the two containers, creating a covered area between the two shipping containers.
- **Delivery Considerations:** Determine if it is possible to get a large delivery truck to the designated cache location. Keep in mind the space needed to drive in, back in (if required), and offload the container. If the ground terrain consists of unconsolidated sand or clay sediments, is wet ground, or a delicate surface such as a turf athletic field, consider the added weight of the delivery truck as it could impact the ground surface. In that case, you may need to make alternate delivery arrangements. Ask what the price is to have the shipping container delivered to the precise location that has been prepared. Note that typically two 20 ft containers can fit on one delivery truck (Figure 15). Hence, if purchasing two containers, there may be a savings on the delivery fee. Smaller trucks may be available to deliver one 10 ft or 20 ft container.



Figure 15: Delivery of Two 20 ft Shipping Containers

Photo courtesy of Susan Graves

If the cache supplies will be stored in an existing building, garage, or storage room, determine what needs to be done to prepare that area for the delivery of supplies.

2.B.3. Building Prep Strategies

The storage container or building selected may need some preparation to minimize maintenance requirements and preserve the life of the items that will be stored. Consider strategies to weatherize, insulate, and seal the structure.

Depending on the local climate, consider approaches that could be used to mitigate the effects of extreme hot, cold, or wet environments. Hot or cold weather can have a significant effect on the temperature inside the cache, which can damage supplies. If using a steel shipping container or a metal shed to store cache supplies, condensation and water droplets can develop inside on the ceiling or sides of the structure. This is sometimes referred to as “container rain” and can result in mildew forming on supplies. Storing cache items in garages and other storage structures that are not heated may also lead to moisture and mildew problems. The following strategies have been adopted by other cache teams to foster a healthy interior environment.

- **Roof:** Consider mitigation measures to protect the roof, such as:
 1. **Paint:** Painting the roof of the storage unit can be an inexpensive mitigation measure. Roof paint can be designed to resist rust, reflect heat, or provide a protective waterproof seal such as an elastomeric coating. Select a paint that aligns with the roof material and meets the team’s mitigation goals.
 2. **Shade Shed:** A more expensive approach is to build a shed over the structure (Figure 16). This could provide added benefits of both prolonging the life of the storage building and providing additional security.
 3. **Shade Roof:** Another option is to construct a shade roof directly onto the shipping container. See the *Joyce Case Study* in Appendix B for drawings, photos, and lessons learned regarding this approach.
- **Heat:** If there is access to electricity, consider running heat into the storage building or container. This option will have ongoing electricity costs and may require local permit fees. A planning team will also need to account for the potential of any associated fire hazards should electrical wiring become exposed or heating systems fail.



Figure 16: Shade Shed with Fencing

Photo courtesy of Jim Buck

- **Insulation:** There are several approaches to consider when deciding to insulate the interior walls and ceiling of a cache building or container. These include: 1) spray-on foam; 2) rolls of reflective foil core insulation that is glued, taped, or stapled on (Figure 17); or 3) foam insulation board applied with Liquid Nails. See Appendix B for examples highlighted in the *Coos Bay* and *Joyce Case Studies*. There are a wide variety of products available. Select one that makes sense for the storage building, climate, budget, and capacity for installing the product.



Figure 17: Reflective Foil Core Insulation
Photo courtesy of Jim Buck

- **Ventilation:** Adequate airflow and ventilation can also contribute to maintaining a healthy interior environment. Steel shipping containers usually come with different configurations of built-in vents (Figure 18). Evaluate the number and size of vents in the container to ensure they will be adequate for your climate. If a plan is made to place two steel shipping containers side by side, consider leaving space between them so that vents are not blocked and can support adequate air flow. (See *Safe Haven Hill's Case Study* in Appendix B).



Figure 18: Shipping Container with 12 Built-in Vents
Photo courtesy of Susan Graves

TIP: PALLETS

If using a shipping container, consider adding wooden pallets for a base on the floor on which supplies may be stacked (Figure 19). Benefits include: 1) pallets enable ventilation/airflow around stored items; 2) pallets can be used in the disaster response for various needs (e.g., floors of tents, wood for burning, etc.); 3) if water barrels or other heavy items are stored on pallets, then a pallet jack or forklift may be used to place and to remove them. This will make it easier to empty and refill the barrels when it is time to rotate the water.



Figure 19: Pallets as Base of Container

Photo courtesy of Cinamon Moffett

- **Dehumidifiers:** Another strategy to reduce moisture is to place moisture-absorber products within the cache. This could include a desiccant carton that is changed out during scheduled inspections, silica packets inside storage totes, moisture-absorbing pouches, or an electric dehumidifier if that is an option for the cache. Some vendors make large [Desiccant Cargo Bags](#) specifically for shipping containers that are designed to hang from the hooks on the walls inside the container (Figure 20).



Figure 20: Desiccant Container Bags

Photo courtesy of Susan Graves

- **Pest and Rodent Control:** Pests and rodents are not typically a problem in steel shipping containers because they are tightly sealed. Pests are most often found in sheds, garages, or storage rooms that have small gaps where rodents or pests can enter to find food or shelter. Remedies to consider include sealing all gaps in the floors, walls, ceilings, and seams. Make sure the doors have a very tight seal. Consider limiting the number of times

doors are opened and for how long, so rodents do not slip into the cache while conducting inspections or maintenance. Packaged food and other products should be kept in tightly sealed durable containers. For added security, consider taping the seals of the lids on containers that store food.

2.C. Securing the Cache

Establish security strategies and access control protocols for the cache. This will protect a community’s investment, prevent misunderstandings, and provide clarity for the team and partners.

2.C.1. Security

Decide how you will secure the cache (e.g., padlock, combination lock, Knox Box, realtor box, or keycard). Shipping containers can have different lock configurations. When ordering a container, be sure to specify any locking requirements. The steel shipping container shown in Figure 21 has three door handles with places for padlocks. It also has one built-in restricted access lockbox in between the two doors that can hold a padlock (see red arrow in Figure 21). This feature makes the cache more secure since it is difficult to get a bolt cutter on the lock. However, it does make the lock more difficult to access. Check the size and configuration of the lockbox to determine what size padlock is needed.



Figure 21: Padlock Configuration with Restricted-Access Lockbox in the Center
Photo courtesy of Susan Graves

TIP: TAMPER RESISTANT LOCK SYSTEM

For buildings that do not have a restricted access lockbox, an option to protect a lock from tampering and weather exposure is to use a lock system device like featured in the *Coos Bay Case Study* in Appendix B and shown in Figure 22. The lock device is made by Abus (model 215/100) with a high security re-keyable padlock (model 37RK/70HB100). It is easy to install with simple tools.

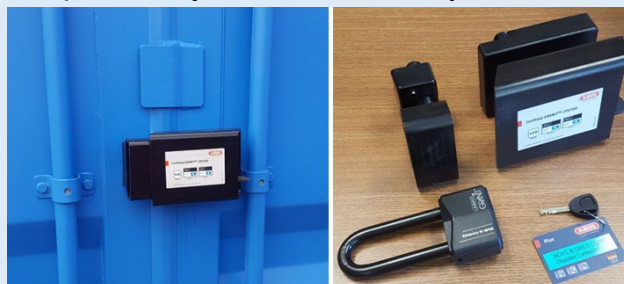

Figure 22: Tamper-Resistant Lock System by Abus
Photos courtesy of Mark Anderson

Additional security measures could include fencing around the cache, solar motion detection lights (Figure 23), security cameras, or an alarm system to monitor the cache. These are all approaches that should be carefully evaluated by the planning team and will be affected by the cache location, type of storage building or container selected, and financial resources. If the chosen cache model requires that supplies are stored in someone’s home or garage, identify how the supplies are accounted for and how they will be secured. The *Seaside Case Study* in Appendix B is an example of this model.



Figure 23: Solar Motion Detection Lights on Fence by a Cache
Photo courtesy of Susan Graves

2.C.2. Access Control

Determine by who, how, and when the cache will be accessed.

Will those authorized have a key or need to know a combination?

Will they need to check out a key, or check in with someone else who will open the cache for them? What is a qualifying reason for access? Establish boundaries around when, why, and under what circumstances someone can access the cache. Here are three examples of reasons to access the cache.

- **Routine Access:** Access will be needed for inspections and routine maintenance, training and exercises, and to rotate or add new supplies to the cache.
- **Outreach:** Access may be allowed for community outreach events, preparedness education, marketing, or cache tours.
- **Disaster:** Access will be needed when there is an earthquake, tsunami, or other disaster requiring deployment of the cache. In this case, make sure people who have keys or combinations are geographically located near the cache to gain access.

Consider establishing a record-keeping system to track who accessed the cache and when, the purpose for the visit, and whether anything was added to or removed from the cache.

2.C.3. Signage

Some caches have signs identifying them as a Community Disaster Cache (Figure 24). This can be beneficial for raising awareness, teaching people where to gather during a disaster, and can be used for open houses, drills, or for encouraging community members towards personal preparedness. Others prefer to keep the presence of a cache confidential due to potential vandalism, theft, or security concerns. The cache team will need to consider their unique situation and goals, weigh the pros and cons of each approach, and decide on a signage plan.



Figure 24: Example of Neighborhood Disaster Cache Sign

2.D. Cache Contents

Selecting the supplies and equipment to store in a cache should be driven by the decisions the planning team made in step 1, Design. If the chosen cache model calls for community members to fill a specific container such as a barrel, tote, or bucket with their own disaster supplies and store them in a designated disaster cache building, consider providing a list of suggested supplies. If the cache plan calls for establishing a standalone disaster cache, refer to the team’s mission statement to guide decision-making about the required supplies and equipment needed for storage in the cache. Always keep the target audience/intended users in mind. Factors such as space availability and funding can also influence content decisions.

2.D.1. Supplies & Equipment

There are different categories of supplies and equipment to consider for storage in a disaster cache. The most common disaster cache supplies are designed to meet basic survival needs such as shelter, warmth, water, first aid, and sanitation. Some caches are designed as gathering areas for medical or search and rescue operations. Other caches are specifically designed to address communication needs or to serve as food distribution centers. When deciding on what to include in the cache, consider the purpose, focus, and scope established in the cache design process. This will help identify specific items needed to meet the original intent for having a disaster cache.

Figure 25 presents general categories of cache supplies and equipment. Refer to *Appendix A: Cache Supplies & Equipment* for an in-depth look at each of these categories.

General Categories of Cache Supplies and Equipment			
Water	Lighting	Comfort Items	Traffic Control
Shelter	Power	Morgue	Transportation
Warmth	Communications	Clean-up Supplies	
Sanitation & Hygiene	Medical	Animals & Pets	
Food	Search & Rescue	Security	

*Figure 25: General Categories of Cache Supplies & Equipment.
See Appendix A for Specific Cache Supplies and Equipment in Each Category.*

During the cache design phase of the planning process, the planning team may have already decided what will not be stored in the cache. If so, this may be a good time to revisit the original purpose of the cache design. If not, this is a good time to make those decisions. For example, if the focus of the disaster cache is communications, a group may decide against storing tents and water. Similarly, if the cache is to be located in a place where community members can retrieve food stored in their own homes, a group may decide against storing food in the cache. The decision not to store food may also be driven by financial limitations around rotating and replenishing expired food supplies. A planning team may enact a safety-related boundary that they will not store highly combustible items such as fuel in the cache. Ruling out

some categories of supplies and equipment will help narrow the focus to the items that match the cache mission.

TIP: SUPPORT ITEMS

As you identify the type of supplies needed to carry out the mission, consider ancillary items that may be needed. For example, cups to serve water, stakes to secure tents, an extension cord for a generator, or batteries for flashlights (refer to Appendix A for more details). Also, consider any instructions or written materials related to a particular resource that may be important to include in the cache (refer to Appendix G for task card examples).

Develop a prioritized and comprehensive list of supplies and equipment for the cache. Even if the list exceeds the current budget, it will help guide future purchases, donations, and grant applications.

2.D.2. Quantities

Determine the quantity of supplies necessary to accomplish the mission. Refer to the planning work already completed to identify the target audience, the number of people the cache will need to serve, and for how long. For instance, if the cache is to serve 300 people, you may decide to purchase 300 rain ponchos and 300 Mylar blankets.

Determine how much space the storage building will accommodate and how much space the supplies will take. If large-capacity tents and water barrels are part of your content list, they should be measured before ordering to see how many can realistically be stored in the container or storage building along with the other cache supplies (Figure 26).

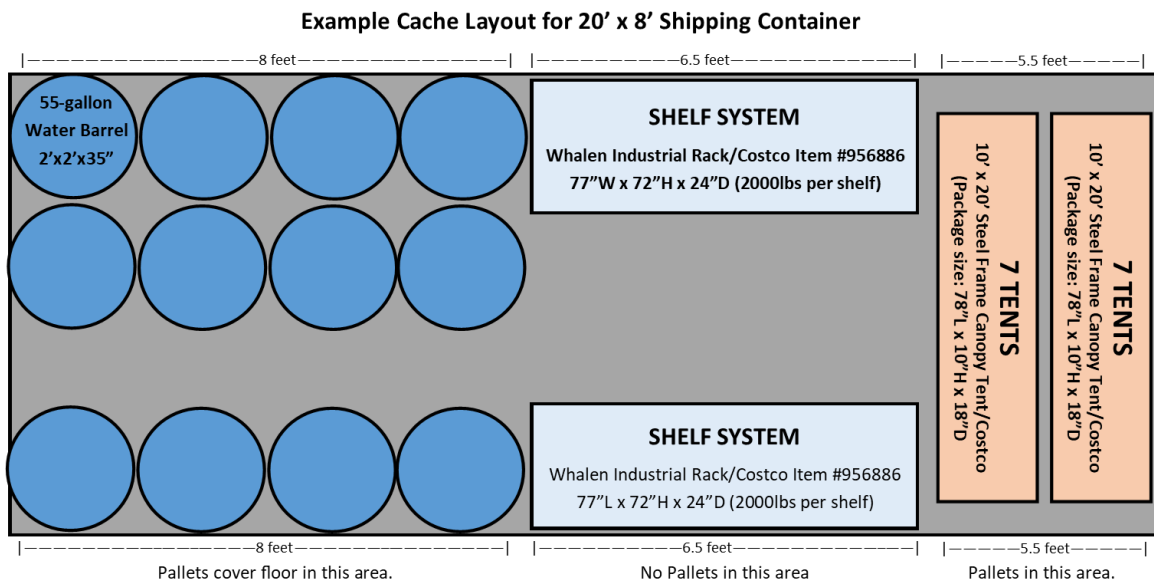

Figure 26: Example of a Cache Layout

If people are storing their own supplies in a specific sized barrel, tote, or bucket, decide how many of the containers will fit within the cache building. All these factors will help define how many items may be stored to accomplish the cache mission.

TIP: HOLDING AREA

Be sure to plan for adequate space to receive and prepare the supplies and equipment before placing them in the disaster cache. You will need space to unpack and inventory items, remove supplies from cardboard packaging, and repackage them into plastic totes. You may decide to put several items in zipper storage bags and have kits ready to distribute (e.g., hygiene kits). All these activities require a temporary holding area.

2.D.3. Storage & Organization: Create an organization and storage plan for the cache supplies. Consider storing items that expire and need to be rotated, as well as items that are needed quickly in a disaster, in easily accessible locations. Consider having an aisle down the middle to make access more manageable for inspections and routine maintenance. These decisions will be easier to make once the content list is established and packaged items are measured.

- **Stacking Strategies:** There are several strategies to consider for stacking cache supplies and equipment. Some groups have the capacity to build their own shelving and customize the shelves to fit their particular cache dimensions and packaged items to be stored. Others are likely to purchase premade shelves and adjust them as needed (Figure 27).

Depending on what is to be stored, consider stacking items on top of each other and avoid the expense of shelving altogether (Figure 28). This is particularly true when storing 55-gallon water barrels. In this case, the barrels could be on the bottom, with a



Figure 27: Pre-made, Adjustable Shelves
Photo Courtesy of Susan Graves



Figure 28: Example of Stacking on Top of Water Barrels
Photo courtesy of Susan Graves

layer of plywood, pegboard, or pallets on top of the barrels to create a flat surface to store the lighter items.

- **Stability:** Determine how to secure or stabilize the shelves and supplies to keep them from tipping over during an earthquake. You may be able to use the built-in hooks located in shipping container walls to secure items. For example, the *Coastal Cache Team* (see the Case Study in Appendix B) decided to secure cache contents by hanging lighter items in sturdy fish nets from hooks near the ceiling. They painted each wall a different color and drew a corresponding map to help identify where items are located in the cache.

The *Eastside Cache Team* (see the Case Study in Appendix B) solved the stability problem by making their own shelves. They connected the shelves with wooden boards on the ceiling to act as stabilizers. The supplies are organized in labeled clear plastic totes and held in place by homemade bungee cords (Figure 29).



Figure 29: Custom Shelving with Stabilizers

Photo courtesy of Bev Meyers

- **Storage:** Budget for plastic bins, totes, buckets, or barrels to store and organize supplies. Cardboard can gather moisture. If the storage building is not weatherized or temperature controlled, minimize the use of cardboard to help reduce opportunities for mildew.
- **Labeling:** Be sure to clearly label each tote, bucket, barrel, or box of supplies so contents are easy to identify for inspections and for cache deployment. Include information on or within each container such as expiration dates, ownership details, and any special instructions. If residents store their own supplies in the cache, create a system to ensure they can identify their belongings and easily retrieve them when needed for maintenance or deployment (see the *Gearhart Case Study* in Appendix B for an example).

Step 2 Summary

Since a disaster cache is primarily about its contents, and how those contents will help to carry out the cache mission, it is important to thoughtfully and strategically decide what to put in the cache and how the supplies will be stored. Working through Step 2 and making these important decisions about Cache Implementation will result in a high-level Implementation Plan (Figure 30). This will provide the groundwork needed for the next step in the cache planning process, which involves maintenance of the cache.

STEP 2: IMPLEMENTATION PLANNING WORKSHEET		
EXAMPLE: TSUNAMI ASSEMBLY AREA CACHE PROJECT		
CACHE LOCATION	MISSION ALIGNMENT	Caches will be established at or near our four Temporary Tsunami Assembly Areas (a church, a city park, a fire station, and a school).
	LAND USE REGULATIONS	County and City Planning Departments indicate there are no restrictions in our designated locations for the use of 10 or 20 ft steel shipping containers.
	HAZARDS & ACCESS	All locations are expected to be accessible after an earthquake. All have access to water for filling water barrels. The fire station does not have a lot of room for setting up a tent city, so the type of tent selected may need to be adjusted for each location.
	WRITTEN AGREEMENT	Written agreements will be in place with each location’s owner before caches are delivered.
STORAGE CONTAINER	TYPE & SIZE OF BUILDING	Supplies will be stored in new 10 or 20 ft steel shipping containers; size depends on the space available at each location and the number of expected intended users. TBD
	SITE PREP	Two sites are on gravel, the other two on pavement. Compacting and leveling the gravel will be necessary. All four containers will be raised on concrete piers. Public Works will donate the materials and labor.
	BUILDING PREP	Apply Reflective Foil Core Insulation to the walls and ceiling of each container.
SECURING THE CACHE	SECURITY	Shipping containers will be secured with keyed padlocks. One on each door and one in the built-in lockbox of each container.
	ACCESS CONTROL	City & Fire will have keys. A key will be placed in the Knox Box at the school and church.
	SIGNAGE	There will not be any signage on the caches.
CACHE CONTENTS	SUPPLIES & EQUIPMENT	<ul style="list-style-type: none"> • Shelter: High-capacity Tent Shelters, Mylar Blankets, Rain Ponchos • Water: Barrels & Pumps, Cups (rotate water) • Toilets: Bucket Toilets & Pop-up Privacy Tents, Toilet paper, Hand sanitizer (rotate toilet paper) • Medical: Basic First Aid Supplies • Operations: Instructions, Record keeping forms, City/Fire Radio (rotate batteries)
	QUANTITIES	Based on minimal basic needs for 72 hours. Still need to determine how many people each will serve.
	STORAGE & ORGANIZATION	We will not use shelves. We will package smaller items into plastic totes and stack them on top of the water barrels and tents. Operating Instructions will be kept just inside the doors.

Figure 30: Example of Completed Cache Implementation Planning Worksheet

STEP 3: MAINTENANCE

STEP 3: MAINTENANCE PLAN

3.A. Exterior Building

- 3.A.1. Physical Appearance
- 3.A.2. Security
- 3.A.3. Functionality

3.B. Interior Environment

- 3.B.1. Moisture/Mildew
- 3.B.2. Pests and Rodents
- 3.B.3. Power

3.C. Contents

- 3.C.1. Visual Inspection
- 3.C.2. Inventory
- 3.C.3. Refresh

To protect the supplies in a community disaster cache, it is important to have a *Maintenance Plan* for servicing the cache. Since disaster caches may be left unused for many years, planning teams may want to develop a cache that is low maintenance. The cache model selected, the type of storage container, and the contents of the cache will impact a cache’s maintenance needs.

If the chosen cache model includes partners in the maintenance task, identify who will be responsible for each aspect of maintenance and how it will be accomplished. Some planning teams develop applications and contracts that organizations, specific groups, or individual residents use to indicate their understanding and agreement to the maintenance

terms. Examples are included in Appendix D.

Establish a timeline and process for inspecting the cache. Specify who will perform the inspection, review the inspection report, and where inspection reports will be kept. The inspection does not need to be done by a professional. It is primarily a visual inspection to ascertain any needed maintenance actions involving the exterior of the building, interior environment, or contents.

CACHE INSPECTION FORM					
Yes responses typically indicate good conditions. *No* responses indicate potential areas in need of maintenance.					
Date of Inspection:		Name of Inspection Team:			
EXTERIOR STRUCTURE			YES	NO	
1	Is the building clear of tree limbs, branches, foliage, or other obstructions?				
2	Is the building on level ground (examine for ground settling and tipping)?				
3	Is the building free of rust, rot, holes, graffiti, or other damage or wear?				
4	Is the building secured (examine for tampering or break-ins)?				
5	Are the locks and doors easy to open and in good condition?				
6	Are cameras or motion detector lights free of cobwebs and grime, and functioning correctly?				
7	Other:				
INTERIOR ENVIRONMENT			YES	NO	
8	Is the interior free of moisture, leaks, water drops on ceiling or walls?				
9	Is the interior free of mildew or other odors?				
10	Is the interior free of signs of pests, rodents, or droppings?				
11	Do the interior lights work?				
12	Other:				
CONTENTS			YES	NO	
13	Are the contents in their normal storage place (examine for tipping over)?				
14	Does the inventory list match up with the actual supplies in the cache?				
15	Do the contents appear to be in good condition and free of damage?				
16	Are all contents within established use dates (examine for expired items)?				
17	Other:				
Actions Taken during Inspection: (repairs made, contents rotated, etc.)					
Actions Needed after the Inspection:					

The Cache Inspection Form (Figure 31) can be used or modified as a checklist to document observations and actions taken during the inspection; a full-size version is provided in Appendix C. Make note of tasks that need to be completed after the inspection and establish a plan for how those will be accomplished.

Figure 31: Example of a Cache Inspection Form

3.A. Exterior Building

Plan how you will maintain the exterior of the cache storage building. Customize this part of the inspection according to your cache model. Consider the following in any given inspection.

3.A.1. Physical Appearance

Examine the cache storage building to see if it is clear of tree limbs, branches, foliage, or other obstructions (Figure 32). Trim foliage around the cache as needed. Check that the building is level and not tipping. Sometimes the ground will settle or shift naturally over time, or the weight of the contents inside the cache will cause the building to tip. Look to see if the structure is free of rust, rot, holes, graffiti, or other damage. Check the roof, gutters, and any canopy or overhead structure used to reduce heat and exposure to weather.

3.A.2. Security

Check if there are any signs of break-ins or tampering with the cache. If there is fencing around the structure, check that it is in good condition. If there are cameras or motion detector lights, check that they are free of cobwebs and grime, and they are functioning correctly.

3.A.3. Functionality

Are locks and doors easy to open? Rust and corrosion of locks or door hinges is a common problem in all coastal environments, but is particularly problematic with used shipping containers. Also, doors may become unevenly aligned due to shifting ground or unbalanced supplies. Locks and hinges may need maintenance due to weather or lack of use.

3.B. Interior Environment

Plan for how to maintain a healthy environment inside the cache. The two most common challenges are moisture and pests. Start by observing: look, listen, and smell for anything unusual or worrisome.

3.B.1. Moisture/Mildew

Check the ceiling and walls for moisture. You may notice condensation and water droplets on the inside of the ceiling and/or sides on the container.

3.B.2. Pests and Rodents

Watch for signs of rodents or pests. Look for droppings or nests. You may also notice a box that has been partially eaten through or is out of place.



Figure 32: Example of Tree Branches Leaning Over and On Cache

Photo courtesy of Susan Graves

3.B.3. Power

If the cache has power inside (electricity, solar power, charging mechanisms), test to ensure it is in good working order. Check that lights, radios, heaters, or other power items operate as intended.

3.C. Contents

Plan for maintaining the items stored within the cache. This involves a physical inventory of the cache and refreshing items as needed.

3.C.1. Visual Inspection

Look to see if anything has tipped over (Figure 33). If so, re-secure those items and determine if a new strategy is needed for more robust securing.

3.C.2. Inventory

Take an inventory and inspect items as you go. Make note of items that are expired or damaged. Doing an inventory is a time to also think about the cache contents and if needs have changed. This can be an opportunity to revisit the mission with the planning team and determine if you are where you want to be and if any adjustments to the scope are needed. If the cache project has any limits on what can be stored (e.g., combustible items like gasoline for generators), check to make sure none of those items have migrated into the cache. If you share space in the cache with other groups or entities, sometimes things can be added to the cache that were not intended.



Figure 33: Example of Tipping Problem Inside Cache
Photo courtesy of Susan Graves

3.C.3. Refresh

Rotate or replace expired or damaged items if you came prepared to do so. Things that typically need to be considered for rotation include water, food, some medical supplies, batteries, and some paper products. Also, change out desiccant or other moisture-absorbing products as needed.

Step 3 Summary

Taking the time to determine who is responsible to maintain each component of the cache is an important part of developing the disaster cache plan. Working through Step 3 to create a maintenance plan aligned with the mission and specific cache model will help to protect the team's investment, so the cache will be in good condition and ready for deployment during a disaster.

STEP 4: DEPLOYMENT PLAN

4.A. Operations Plan

- 4.A.1. Conditions for Use
- 4.A.2. Incident Command
- 4.A.3. Cache Deployment & Management

4.B. Training

- 4.B.1. Practice
- 4.B.2. Evaluate
- 4.B.3. Adjust

4.C. Replacement Plan

STEP 4: DEPLOYMENT

The final step in the disaster cache development planning process is preparing for how the cache will be *Deployed* in a disaster. As teams conduct training and practice runs for how to deploy the cache contents, they will gain confidence and experience in how to use the cache and may even find gaps and ways to improve the cache contents. The factors listed below will aid in effective deployment of the cache in a real disaster.

4.A. Operations Plan

Develop a written Operations Plan that includes seminal instructions about the circumstances under which the cache can be used and how to manage the cache. Some

caches have an “Open Me First” box right inside the door of the disaster cache that contains the operations plan for deploying the cache. See Appendix G for sample operations plans. Consider including the following in the operations plan.

4.A.1. Conditions for Use

Decide under what conditions the cache can be deployed. One way to do this is to refer to the original mission of the cache and draw up a decision-tree that identifies when to open the cache (Figure 34; this example was closely modeled after a decision-tree made by the [Wellington Region Emergency Management Community Emergency Hub Program](#) in New Zealand).

Another strategy is to include the deployment criteria in a written agreement with cache partners. Below is an example of a plan that identifies ‘Conditions for Use’ for a jointly owned disaster cache between a school and fire department:

EXAMPLE: CONDITIONS FOR USE

In a disaster situation when communication capabilities are limited or unavailable, no formal mechanism is needed for the deployment of cache resources. If the school is in session, the school will automatically assume control of cache resources. If the school is not in session, the fire district can take independent action to deploy cache resources as they are able and as needed. While this project has been developed largely for the response to a Cascadia subduction zone earthquake, all parties recognize the possibility that other emergencies or disasters may occur requiring the use of this cache. In that case, the priority will be for the school then to the fire district. In either case, both parties agree to try to communicate with the other about the potential use of the cache.

When to open the Community Disaster Cache

The Community Disaster Cache is opened when a large scale disaster causes widespread damage to buildings, infrastructure, and roads, and when traditional emergency response agencies are not available to assist the community with meeting their basic needs.

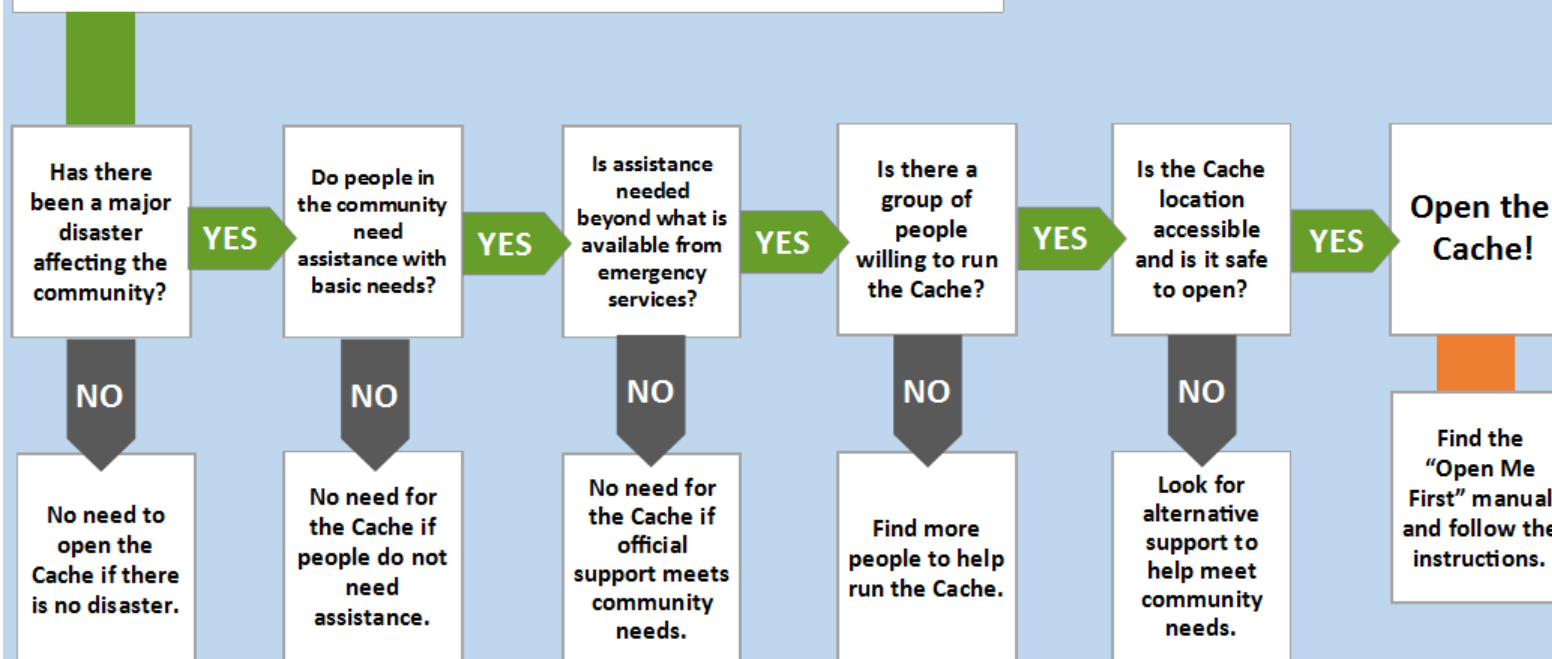

This decision-tree was modeled after the Wellington Region Emergency Management's Community Emergency Hub program.

Figure 34: Example Decision-Tree Depicting When to Open the Community Disaster Cache

4.A.2. Incident Command

It is important to have an easy-to-understand leadership structure to manage the cache when it is deployed during a disaster. Many groups follow what is called the Incident Command System. *Incident* refers to the *emergency* or *disaster*; *Command* refers to the organizational components that identify *who is in charge* of what and who. The plan could also include instructions on how to quickly designate the leadership role in a disaster, and how to appoint helpers, organize the response, and engage with spontaneous volunteers.

- **Organizational Chart:** To plan out an incident command structure, establish an organizational chart. This chart should spell out who is the overall team leader and list other leadership positions in the management structure. The lead person may be called the Incident Commander, Team Leader, or Cache Leader. The organizational chart could represent the broad categories of tasks aligned with the cache mission that need to be accomplished to deploy the cache (Figure 35). For instance, if *Shelter*, *Water*, *Restroom Use*, and *First Aid* are the main cache functions, the leadership structure might include an overall *Cache Leader* who oversees four people: *Shelter Coordinator*, *Water Coordinator*, *Restroom Coordinator*, and *First Aid Coordinator*.

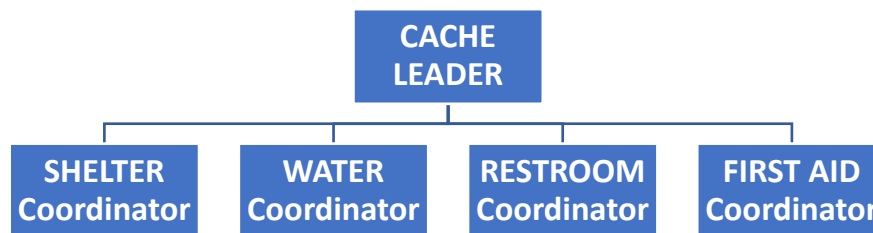

Figure 35: Example Cache Deployment Organizational Chart

- **Identification:** Some groups choose to purchase vests or ID badges for leadership positions so they can be easily identified during a disaster. More examples of disaster cache organizational charts are provided in Appendices B and G.

4.A.3. Cache Deployment & Management

It can be tempting to assume that people who arrive at the cache during a disaster will know how the cache supplies are to be deployed. Between the extreme stress associated with disasters along with a range of opinions, experiences, and skills of those onsite at the time of the disaster, there can easily be disagreements about how the supplies are to be used. Having written instructions in the cache that are easy to locate and follow will contribute to an organized, respectful, and effective cache deployment. The Operations Plan should be customized according to each unique cache model and mission, but it could include the following:

- **Intended Audience:** If the supplies will be shared between different populations such as neighborhood residents and tourists, include what to do if other populations want to use the cache.

- **Staging Areas:** It may include maps, floor plans, and diagrams of potential staging areas. It could also include an inventory list and various forms that will be useful for deploying the cache, including instructions for where to establish essential functions like restrooms, camp areas, and a medical treatment area.
- **Accountability:** It can include a system to account for, track, and manage people who come to the cache. Tracking may include sign-in forms or a simple list, wrist bands, name badges, or a bulletin board where basic information is publicly displayed to help those looking for missing people. Determine what information can be public and what needs to be kept private. An accountability list may also help track the equitable distribution of the cache supplies.



Figure 36: Example Cache Deployment & Management Checklist for Operations Plan

- **Communications:** Include procedures for how communications will work. See Appendix A for things to consider about Communications Strategies.
- **Instructions & Manuals:** The Operations plan may also include instructions or manuals explaining how to use cache equipment like water filtration systems or generators.
- **Task Cards:** Include protocols for how to distribute the cache supplies, such as food rations, water, or hygiene kits. One method is to write Task Cards with instructions for each major task or cache function. If the target population includes people who speak English and Spanish, the cards could be English on one side and Spanish on the other. This is also true for written instructions, signage, and other cache documents. Going through the process of writing out instructions for each task may also help identify other supplies needed to accomplish each function. Two examples are provided in Figures 37 and 38. Appendix G includes additional examples of Task Cards and Operations Plans.

EXAMPLE: FOOD TASK CARD			
(Adapted from <i>Safe Haven Hill</i> – See Appendix B)			
Materials:	<ul style="list-style-type: none"> • Emergency Survival Food Bars • Scissors 	<ul style="list-style-type: none"> • Cutting board • Knives 	<ul style="list-style-type: none"> • Hand sanitizer & bleach • Small zip lock bags
<p>Instructions:</p> <ul style="list-style-type: none"> • Count how many emergency food bars are here. Note the calorie count for each bar type. • Ask the incident commander for a head count. Assume you will need rations for two days and adjust the 800-calorie ration amount accordingly. • Wear gloves or wash hands with hand sanitizer. • Sterilize knives and cutting boards with a small amount of bleach water. • Use scissors to open food bar packages. • Cut bars into 800-calorie portions. The bars are already perforated to help guide you. • Place an 800-calorie ration in each small zip lock bag. • Hand out one zip lock bag to each person each day. • Document distribution. 			

Figure 37: Example Food Task Card

EXAMPLE: RESTROOM TASK CARD			
Materials:	<ul style="list-style-type: none"> • Pop-up privacy shelter • 5-gallon bucket labeled PEE • 5-gallon bucket labeled POOP • Two toilet seats & lids 	<ul style="list-style-type: none"> • Plastic liners • 3-gallon pail • Hand shovel • Restroom signs & clips 	<ul style="list-style-type: none"> • Hand sanitizer • Lantern • Tissue packets • Restroom Instructions
<p>Instructions:</p> <ul style="list-style-type: none"> • Set up a Pop-up Privacy Shelter and hang the Restroom sign above the door. • Hang a lantern from the cross beam inside the pop-up shelter. • Find the 5-gallon bucket labeled PEE. Place the toilet seat/lid on the bucket. • Find the 5-gallon bucket labeled POOP and line it with 2 plastic bags. Place the toilet seat & lid on the bucket. • Place the PEE and POOP buckets in the shelter. • Find a 3-gallon pail and a hand-shovel and fill the pail with a carbon material like dried leaves, pine needles, sawdust, etc. • Place the filled pail and hand shovel next to the POOP Bucket. • Hang the laminated Restroom Instructions Sheet inside and outside the Shelter. <p>NOTE:</p> <ul style="list-style-type: none"> • The PEE bucket is for Pee only - no toilet paper or poop. Close the lid when done. • The POOP bucket is for poop and toilet paper – no pee. Use the hand shovel to sprinkle about a cup of material from the 3-gallon pail to loosely cover the poop. Close the lid when done. • Keep PEE and POOP separate to minimize odors. 			

Figure 38: Example Restroom Task Card

4.B. Training

Develop a training plan that identifies how to test various components of the Operations Plan to validate their feasibility, determine if there are missing steps, or uncover additional supplies needed to accomplish specific tasks. This can be done through physical practice runs or simulated tabletop exercises. Training exercises can lead to more effective deployment of the cache in a real disaster when survivors are under extreme stress.

4.B.1. Practice

Train the team how to use the cache contents. Consider conducting targeted exercises and practice-runs on specific aspects of the cache to see if they are easily deployed and if they adequately meet the mission of the cache.

4.B.2. Evaluate

Identify gaps and ways to improve the cache. You may learn that written instructions are needed to successfully deploy a certain item or to implement a process effectively.

4.B.3. Adjust

Adjust the cache contents and instructions based on lessons learned in the training and evaluation activities. Order new supplies and update the cache inventory list. Edit written instructions to make them more practical. Arrange for new practice sessions as needed.

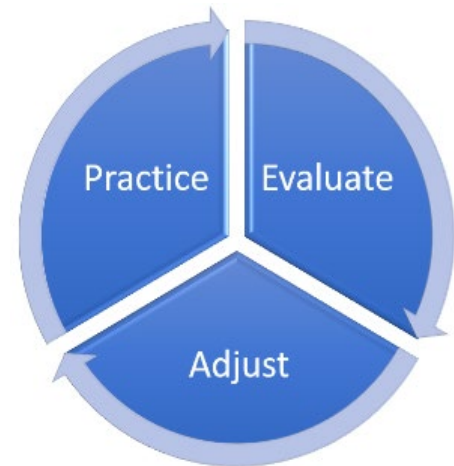

Figure 39: Disaster Cache Training Cycle

4.C. Replacement Plan

The final part of the Operations Plan deals with how and if you will attempt to replace and recover cache supplies after a disaster. If this is important for your operations plan, then keeping accurate inventory lists and documentation will be especially important during the disaster, as this can affect the ability to recover some of these costs. The replacement plan could also be outlined in a written agreement made with disaster cache partners. Here is an example of “replacement plan” language.

EXAMPLE: REPLACEMENT PLAN

Parties using the cache will attempt to reclaim supplies that can be reused and restore them to the cache for future disaster use. If cache supplies are used for a disaster, Parties will try to seek reimbursement from FEMA or other organizations offering support to help replace any consumable inventory cache items. To facilitate this, Parties will work to keep an accurate inventory of the cache and will work to document and keep records of the distribution of supplies and equipment during the disaster.

Step 4 Summary

Creating an organized structure for an equitable, respectful, and caring deployment of the disaster cache has many benefits. It will improve safety at the cache site during a disaster, support the people assigned to manage each task, and ensure supplies are used effectively. Clear processes will reduce misunderstandings when anxiety is high, empower people to work together, and promote confidence in the group’s ability to survive.

See Figure 40 for a list of suggested items to include in the cache that support the deployment. A detailed cache supply and equipment list is included in Appendix A.

SUGGESTED DEPLOYMENT & OPERATIONS PLAN ITEMS		
MISC	OFFICE SUPPLIES	INSTRUCTIONS FOR:
<ul style="list-style-type: none"> • Identification vests • Inventory lists • Maps, floorplans, & drawings of staging areas • Communication tools • Radios & batteries • Warning & signaling devices • Folding tables & chairs • Pop-up canopy for command center 	<ul style="list-style-type: none"> • Pencils & sharpeners • Pens, sharpies, lumber crayons • Paper, all-weather writing pads, notepads • Tape: scotch, duct, & masking • Staplers, scissors, push pins • Clipboards • Plastic sheet protectors to keep documentation dry • Blank name tags • Wrist bands 	<ul style="list-style-type: none"> • Job description Task Cards • Assembling and operating equipment • Setting up and managing staging areas • Tracking and distribution of supplies • Collecting, purifying, storing, & distributing water • Communications equipment & frequency guides • Strategies for accounting for, tracking, and managing people

Figure 40: Deployment & Operations Plan Items to Include in a Disaster Cache

CONCLUSION

Developing a Community Disaster Cache is a strategic preparedness undertaking that addresses specific and critical needs expected to arise as a result of an earthquake, tsunami, or other disaster. Coastal communities must prepare to meet those critical survival needs without federal or state aid for an extended length of time after such a catastrophe.

There are many reasons to develop a disaster cache and planning teams must create caches designed to meet their established priorities. However, developing a disaster cache can be daunting, given the myriad types of cache models, each with different partnerships, scopes, funding implications, and challenges. These challenges are further compounded by the wide variety of supplies and equipment to consider based on the identified mission of a particular cache. There is simply no single, one-size-fits-all approach.

This *Guide* presents a practical four-step planning process to empower communities to design a disaster cache that will meet their unique needs, goals, and limitations. The content provided in this guide has been informed by numerous communities and groups who have successfully created disaster caches along the coasts of Oregon, Washington, and California. By compiling the experiences, insights, lessons learned, and recommendations gleaned from these groups into a single comprehensive manual, our hope is to systematically reduce the burden that communities face when considering developing disaster caches.

Working through this four-step planning process to develop a community disaster cache plan will better position planning teams to put the plan into action and develop a customized disaster cache to support their specific community. Completing this important task is an essential part of a community's Cascadia subduction zone earthquake and tsunami preparedness efforts.

APPENDICES OVERVIEW

APPENDIX A: CACHE SUPPLIES & EQUIPMENT

Appendix A contains thirteen sections featuring the most common categories of supplies and equipment that might be included in a disaster cache. Each category includes: 1) a brief overview of the subject matter; 2) a table identifying a suggested list of supplies and equipment; and 3) a discussion of things to consider, lessons learned, tips, and cautions directly related to that specific category. Section A14 is a tabular compilation of the material in sections A1-A13.

APPENDIX B: CASE STUDIES

Appendix B features eleven case studies showcasing different community disaster cache projects, each customized to meet their specific goals and unique community situations. Each is an example of one of the Community Disaster Cache *Models* identified in the planning *Guide*. The two-page case studies provide a high-level overview of each disaster cache project; detailed plans from several are included in the ensuing appendices.

APPENDIX C: TEMPLATES

Appendix C features several disaster cache planning templates, worksheets, and forms that can be used or modified to meet the unique needs of a community disaster cache planning team. Each template corresponds with the work planning teams perform during the four-step community disaster cache development planning process.

APPENDIX D: SAMPLE AGREEMENTS

Appendix D features a variety of agreements, applications, and resolutions that correspond with four existing disaster cache projects included in the Case Studies. Also included is a Memorandum of Understanding (MOU) template to help planning teams spell out the responsibilities of each cache partner regarding the location, funding, ownership, and maintenance of the cache.

APPENDIX E: INNOVATIVE STRATEGIES

Appendix E features six innovative strategies others have developed and incorporated into their community disaster caches projects or community disaster preparedness initiatives.

APPENDIX F: SAMPLE BUDGETS & SUPPLY LISTS

Appendix F features examples of budgets and supply lists from five disaster cache projects included in the case studies. Also included is a basic-needs cache budget for 300 people and a budget worksheet template.

APPENDIX G: SAMPLE OPERATIONS PLANS & TASK CARDS

Appendix G features operations plans from four disaster cache projects included in the case studies. Each provides instructions in different formats such as task cards, protocols, job lists, or just basic instructions. Also included are an example of a decision-tree flowchart to help determine when to open a disaster cache and a Task Card template.

APPENDIX H: DISASTER MORGUE EXAMPLES

Appendix H features two comprehensive approaches to dealing with the deceased during a large, catastrophic disaster such as a Cascadia subduction zone earthquake and tsunami when professional responders are not available to perform these important roles.

APPENDIX I: REFERENCES

Appendix I features a list of earthquake and tsunami disaster preparedness websites, several individual and community preparedness resources, and references corresponding to the topics, concepts, and strategies discussed in the *Planning Guide*.

APPENDIX A: CACHE SUPPLIES & EQUIPMENT

Overview: Determining what supplies and equipment to include is an important task in setting up a community disaster cache. Appendix A expands on Section 2D “Cache Contents” in the main body of the Community Disaster Cache Planning Guide. It is broken down into thirteen sections featuring the most common categories of supplies and equipment that might be included in a disaster cache (Figure 41). Section A14 is a tabular compilation of the material in sections A1-A13.

General Categories of Cache Supplies & Equipment			
Water	Lighting	Comfort Items	Traffic Control
Shelter	Power	Morgue	Transportation
Warmth	Communications	Clean-up Supplies	
Sanitation & Hygiene	Medical	Animals & Pets	
Food	Search & Rescue	Security	

Figure 41: General Categories of Cache Supplies & Equipment

Each category includes: 1) a brief overview of the subject matter; 2) a table identifying a suggested list of supplies and equipment; and 3) a discussion of things to consider, lessons learned, tips, and cautions directly related to that specific category. The last section in Appendix A contains all the tables of suggested cache supplies and equipment. The tables are not exhaustive but provide a good starting point.

Please note any reference to or photographs that depict a brand or product does not indicate an endorsement of any particular product. These are included as examples of what other disaster cache planning teams have tried or considered. Each disaster cache planning team can take these suggestions and strategies into consideration as they work to identify the specific items that meet their mission, goals, and unique situation, and that align with any specific policy considerations from their jurisdiction.

Appendix A Table of Contents

A1. WATER	54
A2. SHELTER	60
A3. WARMTH	66
A4. SANITATION & HYGIENE.....	69
A5. FOOD	73
A6. LIGHTING	78
A7. POWER.....	79
A8. COMMUNICATIONS.....	82
A9. MEDICAL	84
A10. SEARCH & RESCUE	86
A11. COMFORT.....	88
A12. MORGUE	90
A13. MISCELLANEOUS ITEMS.....	91
A14. SUGGESTED SUPPLIES & EQUIPMENT	93

A1. WATER

A1.1. Storing Water

A1.2. Collecting Water

A1.3. Purifying Water

A1.4. Distributing Water

In a catastrophic disaster when water supplies are very limited, survivors will have to be creative, disciplined, and strategic about water collection and distribution. Water is needed for survival. Experts recommend that people generally need ½ gallon of water each day for drinking and another ½ gallon for hygiene and sanitation. Refer to FEMA’s guidance on [Water](#) at Ready.gov. Needs will vary depending on the person, one’s activity level, and the climate.

Water is also needed for cooking, cleaning, and for medical purposes. Water is heavy, takes space, and is difficult for people to carry large amounts in their personal emergency go-bags.

If your cache mission supports addressing the need for water, there are four factors to consider: storing water, collecting water, purifying or filtering water, and dispensing or distributing water.

Here are some examples of water supplies to consider (Figure 43):

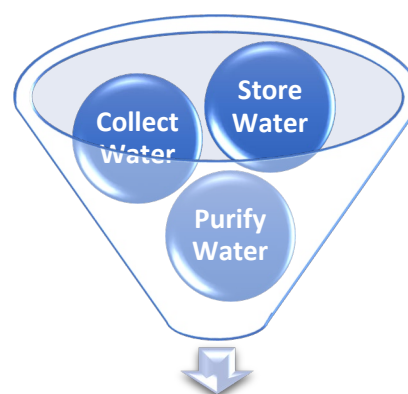

Distribute Water

Figure 42: Four Factors for Caching Water

SUGGESTED WATER ITEMS			
STORAGE	COLLECTION	PURIFYING	DISTRIBUTING
-Bottled water -Packaged water -Water storage containers -55-gallon barrels with bung wrench, hand pump, & purifier solution	-Water collection containers (jugs, buckets & lids) -Water heater siphon & instructions -Gutter downspout diverter & spigot -Tarps -Bungie cords	-Strainers, coffee filters -Water filtration or purification systems -Water filter straws or bottles -Non-scented bleach -Measuring cup -Water purification tablets or drops -Water purifying brochures -Pans for boiling water -Fire making materials	-Funnel -Hand pump -Cups -Collapsible water bottles -Hand truck -Buckets

Figure 43: Suggested Water Items

TIP: A NOTE ABOUT PLANNING

It can be valuable to consult with the agency or organization that traditionally provides water for your community to help you understand local water infrastructure conditions. They may have a disaster water plan or be able to provide expertise and partner with you to develop a water plan for the cache.

A1.1. Storing Water

If you decide to store water in the cache, consider the benefits and drawbacks as well as different methods of storing water.

- **Benefits & Drawbacks**

There are significant benefits to storing water in the disaster cache. First, your target population will have an initial water supply to meet their immediate survival needs. Next, this can buy time to begin collecting water, setting up a water purification process, and establishing a water distribution system. Finally, in addition to the actual life-saving benefits of being hydrated, people will also benefit from the psychological comfort of knowing they have water to survive.

There are also drawbacks to storing water. Water takes up a lot of space. It can contribute to condensation, potentially damaging other items in the cache. Water has a limited shelf-life and will need to be rotated, which requires time and ongoing effort.

- **Pre-Packaged Water**

Packaged water such as individual bottles, boxes, cans, or foil packets can be good choices for cache storage because they are easy to distribute. They have expiration dates printed on the packaging and may need to be rotated out of the cache; however, even expired water may be suitable for sanitation purposes or for drinking if effectively purified.

- **Water Storage Containers**



Figure 44: Filling Three 55-gallon Water Barrels

Photo courtesy of Susan Graves

If the decision is made to store water, it should be stored in a cool, dark place. Water storage containers vary in size and features, from 5-gallon hand-held containers to 15-, 30-, 55-, and 160-gallon barrels or drums. There are stackable choices too. The 55-gallon water barrels appear to be the most economical choice (and most common) for large-capacity water storage (Figure 44). Whatever size container you choose, get new food-grade polyethylene, BPA-free barrels that meet EPA standards. Some containers require a special tool called a bung wrench to open, and a

hand pump to dispense the water. A water purifier solution can be added to make the water safe to store for 5-years. Use a food-grade drinking water hose to fill the barrels, leaving some space at the top in case the water freezes and expands.

TIPS: WATER BARRELS

1) When filling the barrels, be careful not to get any of the purifier solution on your clothes as it will leave bleach spots. 2) Make sure the barrels are on wood flooring rather than concrete to avoid an adverse chemical reaction. 3) Pallets can be a helpful base because a pallet jack or forklift can remove a pallet full of barrels when it is time to empty and refill the barrels in five years. 4) A barrel dolly (Figure 45) can also come in handy for moving the barrels into position once filled or when it is time to rotate the water.



Figure 45: Water Barrel Dolly

Photo courtesy of Susan Graves

- **Large Caged Containers**

Water can also be stored in 275-gallon caged containers. A disaster cache planning team in Depoe Bay, Oregon originally stored these large water containers inside their steel shipping container, but it unfortunately created condensation. They solved the problem by building a shed adjacent to the shipping container to house the two 275-gallon caged water containers (Figure 46). Now they have more room in their shipping container to cache other supplies and have solved the condensation problem.



Figure 46: Two 275-gallon Caged Water Containers. Left: shed during construction. Right: finished shed.

Photo courtesy of Susan Graves

CAUTION: REFILLABLE CONTAINERS

If you are going to store water in refillable containers, here are two things to consider. 1) Avoid storing water in glass containers as they can easily break in an earthquake. 2) Do not store water in barrels that were previously used for storing food, beverages, or any type of chemical, as it is very difficult to be assured all the prior residue has been fully removed, which may result in bacterial growth. See FEMA's [Food and Water in an Emergency](#) brochure for more details.

A1.2. Collecting Water

If water collection is a strategy for the cache, determine the supplies needed to find and gather water. You may decide to keep a stock of buckets, jugs, and various other storage containers for collecting water. If the cache is located at an assembly area where you anticipate people will gather for an extended period of time, you will need to quickly set up water collection systems and continue gathering and purifying large amounts of water. Consider devising a plan utilizing fresh water sources including rainwater and/or household water heaters.

• Fresh Water Sources

Identify streams, creeks, ponds, lakes, rivers, and other water sources near the cache. Tsunami waters are expected to carry a lot of hazardous debris and salt water, so avoid harvesting water from sources that have been inundated by the tsunami. Also check the creeks and streams for other possible sources of contamination. Boiling, purifying, or filtering water collected from creeks or streams is essential.

• Water Heaters

Another strategy is to keep water heater siphon supplies in the cache in case residents are able to get back into their own homes (if safe to re-enter) and can retrieve water from their home water heaters. See Appendix E for step-by-step instructions for water heater siphoning. Keep copies of these instructions in the cache operations plan.

• Rainwater Harvesting

Rainwater can be used for sanitation and hygiene purposes and possibly for drinking if it can be safely purified. Read the CDC's guidance on [Rainwater Collection](#). There are many creative ways to collect rainwater. One strategy is to store downspout diverters & spigots in the cache and use them to divert water from a roof gutter downspout to a water collection container. Do not collect rainwater for *drinking* from a wood shingle roof or a newly applied asphalt roof due to potential chemical contamination. Another strategy, featured in Appendix E as an innovative strategy, involves hanging tarps or plastic sheeting to collect rainwater and divert it into a water purification system.

CAUTION: WATER SAFETY

When it comes to drinking water, safety is paramount. Err on the side of caution. Do not drink water if you suspect the water is unsafe due to any of the following conditions: Contaminated by sewage or poisonous substances, is a dark color or has an odor, or contains chemicals, oils, or solid materials.

A1.3. Purifying Water

Once you've collected water, you will need to take measures to ensure it is safe to drink.

- ***Boiling or Treating Water***

Supplies and instructions for purifying water can be helpful items to store in the cache. If you store large quantities of the FEMA and the American Red Cross brochure entitled "[Food and Water in an Emergency](#)" in the languages of your target population, they can be handed out at the cache (Figure 47). This will empower survivors with the knowledge needed for safe water purification methods, such as boiling water, chlorination, and distillation. The Seattle Emergency Communications Hubs (2014) put together a 1-page [Water Poster](#) (See Appendix E) showing practical considerations for water in a disaster. Along with the printed instructions, consider storing items such as non-scented bleach, large pots for boiling water, and water purification products (e.g. tablets or drops).

- ***Water Filtration Systems***

Another item to consider storing in the disaster cache are water filtration systems. Individual water filter straws and community water filtration systems are two common water filtration strategies. Note: strainers, coffee filters, paper towels, or layers of clean cloth can be useful to have on hand. These items can increase the life of your filter serving as a first step to strain out some of the sediment in the water before running the water through the filtration system.

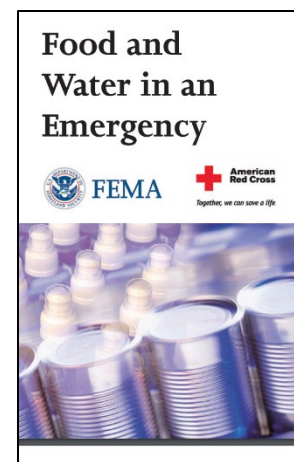

Figure 47: FEMA's Food & Water in an Emergency Brochure

TIP: FILTERS VS. PURIFIERS

REI Co-op (2021) has a useful article entitled, [How to Choose a Water Filter or Purifier](#) that includes information on the difference between filters and purifiers, types of water filters and purifiers, the role of the pre-filter, and water treatment best practices.

- ✓ ***Individual Water Filter Straws:*** There are a growing number of portable water filter straws on the market for individual use. Some are handheld while others connect

directly to a water bottle or drinking pouch (Figure 48). Some filter as few as 20 gallons of water while others are rated for up to 100,000 gallons. Features and prices vary greatly, with some costing as low as \$6 each and others \$35 or more. Check the filter specifications to see what bacteria and contaminants they address. Water filter straws take up very little storage space in a disaster cache. By storing a quantity of individual water filter straws for distribution, you will be able to empower your target audience to take care of their own water needs.



Figure 48: 20-gal Water Filter Straw, 100-gal Water Filter in Bottle, 100,000-gal Water Filter Straw

Photo courtesy of Susan Graves

- ✓ **Community Water Filtration Systems:** There are a variety of filter and purification systems on the market that can process a large amount of water in a short period of time and are designed for larger groups of people. Some require power, others do not. The [LifeStraw Community Water Purifier](#) system does not require electricity or batteries and has a flow rate of about 3-gallons per hour. The [Agua Munda](#) filtration system uses a hand crank and can filter 200-gallons per hour. Others, like the [Trekker Portable Water Purification Unit](#) made by Noah Water Systems require 12-volt DC power to operate but can filter 60-gallons per hour. Each system has different features as well as pros and cons. However, any of these can be viable water filtration options for large groups of people depending on their circumstances.

A1.4. Distributing Water

Determine what supplies you will need for the practical and operational steps to distribute water to your target audience. Does your cache mission involve serving water for individuals staying in a temporary camp near the cache, or is your plan to distribute larger quantities of water to groups gathered elsewhere? These factors may impact decision-making on the supplies to cache for distribution. Items may include cups, water bottles, hand pumps, hand trucks, buckets, or containers for water delivery.

A2. SHELTER

A2. SHELTER

A2.1. Shelter Considerations

A2.2. Shelter Types

A2.3. Set-up Requirements

A2.4. Other Considerations

A2. SHELTER

After a large earthquake, and the inevitability of numerous aftershocks, it may not be feasible for people to take shelter inside buildings. Yet, shelter is one of our most basic needs. Keeping people out of inclement weather and in a protected space is important to survival. Not only does shelter provide protection from rain and moisture, but it provides a sense of space, security, and some privacy.

Shelter supplies typically stored in disaster caches include items like tents, tarps and the materials needed to assemble and firmly secure the tents.

Here are some examples of shelter supplies to consider (Figure 49):

SUGGESTED SHELTER ITEMS			
SHELTER/TENTS	TIE-DOWNS	SET-UP	MISC
-Tarps -Pop-up canopies -Camping tents -High-capacity tents -Plastic shower curtains -Plastic sheeting (Visqueen)	-Rope, paracord, tie-downs, bungee cords -Carabiner clips, zip ties -Stakes, spike nails -Hammer or rubber mallet -Sandbags and shovels -Orange flagging tape -Tennis balls, pool noodles	-Step stools -Furniture moving straps -Waterproof Seal -Identification tags -Labels or signs for tents -Sharpies -Scissors or knife	-Tent assembly instructions -Tie-down strategies -Laminated tarp shelter plans -Camp organization diagrams -Knot-tying instructions -Tent assignment forms -Plastic storage totes -Moisture absorbent packets

Figure 49: Suggested Shelter Items

A2.1. Shelter Considerations

When thinking about shelter needs, consider your cache mission, the location of the cache, your target audience, and your budget. The following questions should be explored:

- **Mission**

What is the intent of the shelter? Do you need temporary pop-up canopies as locations for quickly huddling out of the rain, disseminating information, or distributing supplies? Or, will you be setting up a temporary camp and need shelter for your survivors to sleep in?

- **Location**

Do you anticipate the shelters will stay in place near the cache once erected, or will they need to be portable so they can be easily moved to a different short-term location?

- **Target Audience**

How many people does the shelter need to serve? Do you need high-capacity tents for a large group of school children to immediately gather and protect them from the elements, or will you need small personal or family-size tents? Determine how many people can stay in each tent.

- **Budget**

How much money do you have to work with for meeting shelter needs? Depending on your budget and mission, sheltering can be managed on a limited budget or may require a more substantial investment.

A2.2. Shelter Types

There are many types of shelters to choose from. They vary in price, size, features, and quality. Some are much easier to set up than others. They also vary in their packaged size, which is important to know when figuring out what will fit in the cache. Determine what is in line with your mission and feasible for your storage space and budget.

- **Tarp Shelters**

If your storage space and budget are limited, consider Tarp Shelters or Tube Tents (Figure 50) as an economical alternative to tents. Provide a tarp, rope, and a laminated instruction sheet for constructing make-shift shelters. See *Eastside's Case Study* in Appendix B for an example of this strategy. Additional supplies include sturdy zip ties or carabiner clips for attaching tarps to nearby supports.



Figure 50: Pre-made Tarp Shelters can be purchased as a Tube Tent
Photo courtesy of Susan Graves

TIP: SHOWER CURTAINS & VISQUEEN

Plastic shower curtains can be purchased at many “dollar” type stores for only \$1.00. These economical shelter-type items store well, take up very little space, and could be an alternative for tarps. Likewise, large rolls of plastic sheeting, like Visqueen, can also be used for sheltering purposes.

- **Pop-up Canopies**

Pop-up canopies can be erected with minimal effort and can provide a place to quickly huddle under to get out of the rain. They can be used for specific functions like establishing a check-in & information center, a medical treatment area, or a place to distribute supplies. Pop-up canopies can be easily moved to another location if needed. Additionally, tarps can be added to the sides for creating an enclosed shelter.

- **Camping Tents**

Some planning teams choose to store camping tents of various sizes in their cache. This allows for them to distribute tents to individuals, couples, or families that arrive at the cache. Camping tents provide privacy and can increase self-sufficiency for smaller groups of people.

TIP: END OF SEASON SALES

Camp gear like tents and pop-up canopies can often be found on closeout sales or at highly discounted prices near the end of the summer recreation season. Conversely, they might be less plentiful and more expensive during the off-season.

- **High-capacity Tents**

High-capacity tents could be used for sheltering large groups of people, as medical treatment area tents, command centers, or for communications tents. Figure 51 shows an example of a high-capacity tent that Lincoln County School District stores in their disaster caches for sheltering large numbers of students and staff after an earthquake. This sturdy 10' x 20' steel frame canopy has four screened windows, a side door with awning, and roll-up zipper doors on both ends. It can be assembled by two people; no tools are needed but step stools are helpful to assist with reaching the beams for attaching the side panels. An additional 10' x 20' tarp is needed for the floor.



Figure 51: Teen CERT Students Assembling a High-capacity Tent

Photo courtesy of Susan Graves

Lessons learned include: 1) The boxes are extremely heavy (165 pounds) and difficult to move so the school caches contain a set of furniture moving straps to move the boxes to the desired tent locations. 2) If you decide to practice setting it up, it is very difficult to get all the pieces back in the box. 3) These shelters are economical (approximately \$230 at Costco), but they are not available online or for delivery. Arranging delivery of these large, heavy items has been challenging.

CAUTION: HEAT SOURCES & TENTS

Do not use any kind of heat sources inside tents. Tents may be flammable, even those that say they are flame retardant/resistant. Be careful to keep heating appliances or campfires away from tents, as well. These can be significant safety hazards.

A2.3. Set-up Requirements

There are several set-up factors to consider. These include tent specifications & features, securing tents, and camp organization.

- ***Specifications & Features***

Examine these questions about the tents under consideration to further aid in decision-making regarding shelter: 1) What is the package size and weight for storing the tents? 2) How difficult are they to move from the cache to where they will be set up? 3) How many people are needed to assemble the tents and how complicated is it? 4) Are additional supplies needed for setting up the tents such as tools, stepstools, or extra tarps for underneath or over the top of the tents?

Planning teams can also examine special features the tents have that might address other needs. For example, a tent may have pole crossbeams to hang LED lanterns. The same crossbeams could be used to hang dividers (such as shower curtains) for partitioning out sections of the tents. If the projected camp area is in a known windy area, you may consider tents that are shorter and not as easily caught by the wind. If you plan to purchase a lot of tents, you may consider buying a couple of different models and testing them out to see if they meet your needs before making your final selection and purchase.

- ***Securing Tents***

In addition to tents, you will need supplies to secure tents and canopies from wind and other hazards. Do not underestimate the power of the wind as it can easily dislodge tents, causing injury. In addition to tie-downs, rope, and stakes (and hammers for the stakes), you may consider storing a stash of empty sandbags and some shovels. These can provide additional ballast from the wind.

CAUTION: TIE-DOWNS & TRIPPING HAZARDS

Tie-downs with rope and stakes often extend out quite far from each tent, which could cause a tripping hazard. Consider attaching orange flagging tape on the tie-downs and either tennis balls or small pieces of pool noodles to the top of the stakes to alert people to their presence. Take this distance into consideration when planning out spacing between tents.

- ***Camp Organization***

If the cache mission involves sheltering people in a tent, the planning team may want to develop instructions for how to set up a temporary encampment or tent city, and how to organize tents in rows or other patterns depending on the space available. Include printed maps or diagrams of the suggested camp areas in the instructions. Think about how school classrooms are configured with walking space (halls) in between classrooms and gathering areas (e.g., medical area, cafeteria). Position the tents strategically, leaving adequate room in between for tent stakes and tie-downs, walking, evacuation, and air flow. Plan for how to label the tents so occupants can be assigned to a tent and easily identify their tent. You may use a sharpie pen to number the tents or have pre-made laminated signs that are stored in the cache that will attach to tents as they are deployed.

TIP: TENTS & WATER COLLECTION

Rain will gather on and fall from the top of the tents. This may be a water collection source. Remember this when positioning the layout and organization of tents.

A2.4. Other Considerations

There are two additional factors to consider when it comes to shelter. 1) if residents store their own tents in the cache, and 2) if your plan is to use a building for shelter, so tents are not needed.

- ***Personal Tent Storage***

If residents load their own shelter supplies into a specific sized barrel or tote, be sure to provide dimensions of the barrel or tote so that residents can make informed decisions about the packaged size of tents and what might feasibly fit in a barrel along with the other items they intend to store.

- ***Indoor Shelters***

If you are caching supplies for an indoor shelter, such as a seismically sound building that can be safely reoccupied after an earthquake and its aftershocks, your shelter supplies might be substantially different. For instance, you might cache partitions to create defined spaces and separate sleeping areas rather than tents and stakes. And your focus may be more on cots, sleeping supplies, comfort, and warmth. Information about these items is in section A3 Warmth.

TIP: CARDBOARD & MOISTURE

Tents, tarps, cots, and other shelter items often come in cardboard boxes, which can gather moisture and mildew. This is important to consider if the disaster cache is not temperature controlled. If these items are small enough, you may be able to take them out of the cardboard boxes and put them in individual plastic storage totes for long-term storage. Consider adding moisture-absorbent packets (e.g., desiccant) to each tote.

A3. WARMTH

A3. WARMTH

- A3.1. Clothing
- A3.2. Blankets
- A3.3. Hand Warmers
- A3.4. Cots
- A3.5. Campfires & Stoves

A3. WARMTH

After an earthquake, when your community is without power, it will be important to keep dry and warm. Without heat, hypothermia becomes a risk factor. If addressing *warmth* is part of the cache mission, think through what is feasible to store. When deciding on warmth items for the cache, factor in the space they require and how well these items will store in the cache long term. You will have more options available to consider if the cache storage area or building is insulated or heated to help minimize mildew.

If the cache is designed for a neighborhood in which its residents plan to retrieve warmth items from their own homes if it is safe, or from their vehicles, that may also influence decision-making on the type of items to store in the cache.

Here are some examples of warmth supplies to consider (Figure 52):

SUGGESTED WARMTH ITEMS			
STAYING DRY & WARM	CLOTHING	FIRE STARTERS	MISC
-Tarps -Plastic shower curtains -Plastic sheeting -Mylar blankets -Cloth or wool blankets -Sleeping bags -Cots & mattress pads	-Rain ponchos or rain gear -Coats -Hats, scarves, ear muffs -Socks & gloves -Hand & foot warmers -Clothes lines & pins	-Fire starter materials & instructions -Lighters -Fine steel wool -Lint/toilet paper rolls, & votive candles -Flint & steel -Magnifying glass -Waterproof matches	-Buckets/totes for gathering fire-making supplies -Hatchets, knives -Camp grill grates

Figure 52: Suggested Warmth Items

A3.1. Clothing

An important way to keep people warm is to help them stay dry. Rain ponchos or rain gear are common items stored in disaster caches. Rain ponchos vary in quality, thickness, and length. Some disposable rain ponchos are super thin and tear easily but cost less than a dollar. Others are more substantial and provide a measure of warmth but are more expensive. Some have pants to go with the top. Others have gromets on the corners so that the poncho can convert into a type of shelter if needed. Some are lined with a Mylar thermal material to give warmth in addition to protection from rain. Cold weather gear such as coats, socks, hats, and gloves are other potential warmth items.

TIP: ECONOMICAL SOLUTIONS

Tarps, plastic shower curtains, or rolls of plastic sheeting, such as Visqueen, could be used to huddle under to try to stay out of the rain. Plastic garbage bags can be turned upside down with holes cut for arms and head openings. Be careful of this strategy for children because of suffocation risk.

A3.2. Blankets

Cloth blankets, wool blankets, or sleeping bags can keep you warm and provide comfort, but they take up a lot of space in a disaster cache and can collect moisture over time. If you have a temperature-controlled storage space and plenty of room, these are practical items to have in a cache.

A more versatile option is Mylar blankets (Figure 53). Mylar blankets look like aluminum foil and are also referred to as thermal, emergency, or space blankets. Benefits include: they are very warm, take up little space, are not subject to the same moisture concerns as cloth alternatives, and are very affordable. Individually wrapped Mylar blankets can be purchased online for less than 50 cents each. Mylar blankets, sleeping bags, rain ponchos, and small Mylar tents are readily available online. A drawback to Mylar is that they are not cozy like cloth.

A3.3. Hand Warmers

Single-use hand and foot warmers or heat packs take up very little space in a cache, are resistant to moisture, and are inexpensive (Figure 53). Once opened, they can provide warmth for 5-24 hours depending on the product. They have the added benefit of immediate warmth as well as a sense of comfort but have a short shelf-life.

A3.4. Cots

Cots help people stay off the ground while sleeping, increasing the ability to stay dry and warm. However, they can be costly and take up a lot of space. Be sure to check on the stored size of the cots to make sure it is feasible for the disaster cache storage area. Factors to consider: how the cot folds, size (child, adult, long, etc.), weight capacity, adjustability (head and foot areas), and extras (like mattresses).



Figure 53: Mylar Emergency Blanket and 24-hr Heat Pack Warmer

Photo courtesy of Susan Graves

TIP: AMERICAN RED CROSS

If your mission prioritizes cots, and you have space for them, connect with your local American Red Cross partners. Check to see if they have a supply of cots that need a designated storage space. They may even have cots that have been used for training purposes that need a new home.

A3.5. Campfires

Campfires can provide a place to gather around as an important part of your warmth strategy.

- **Campfires**

Makeshift fire pits can be built with items stored in the cache or found near the cache or camping site. If wood is plentiful near the cache or encampment area, consider adding buckets or other containers to the cache for collecting kindling, firewood, or rocks for a fire pit. You may want to have instructions in your cache for building campfires that include safety cautions such as [Smokey Bear's Campfire Safety Guide](#) (USDA Forest Service, 2012).

The ability to boil water to provide something warm to drink can also be part of your warmth plan. A camping grill grate to place on top of a campfire is a useful item to store in the cache, making it more feasible to boil water and cook on a campfire. These grates are very inexpensive and take up little space in a cache.

- **Fire Starters**

There is a large variety of fire starter products available such as flint and steel, waterproof matches, rechargeable lighters, and various kinds of fuels (Figure 54). Check to see if they are flammable when stored, and if they have a limited shelf-life that requires rotation. If you do decide to store fuel in the cache, you will need to decide what type of fuel is needed and consider any hazards involved.



Figure 54: Fire Starter Supplies: Flint & Steel, Rechargeable Lighter

Photo courtesy of Susan Graves

TIP: FIRE STARTER KITS

One disaster cache team made their own fire starter kits. They collected empty toilet paper rolls and paper towel rolls. They stuffed them with dryer-lint from a local hotel, and with a votive candle. They also used egg cartons with lint and votives. These were placed in plastic totes for storage.

A4. SANITATION & HYGIENE

A4. SANITATION & HYGIENE

- A4.1. Temporary Toilets**
- A4.2. Human Waste Disposal**
- A4.3. Hand Washing**
- A4.4. Personal Hygiene**

A4. SANITATION & HYGIENE

In a catastrophic disaster such as a large earthquake and tsunami, sewer and water systems are not likely to be operational. If your disaster cache mission includes addressing sanitation and hygiene needs, like restroom use and handwashing, you will need to determine the type of supplies needed for the level of support the cache will offer. Having an easy-to-use process established for managing human waste safely will help prevent the spread of disease and provide a system to meet this basic need.

Here are some examples of sanitation and hygiene supplies to consider (Figure 55):

SUGGESTED SANITATION & HYGIENE ITEMS			
TOILET	PRIVACY	WASHING	PERSONAL HYGIENE
-5-gallon buckets & lids -Toilet seat or pool noodles -Commode, urinal, bedpans -Heavy-duty trash bags -Toilet paper -Scoops, hand shovels -Pails, buckets -Filler: cat litter, shredded paper, saw dust, lime -Gloves	-Pop-up privacy tent -Tarps, plastic sheeting, or plastic shower curtains -Clothesline and pins -Carabiner clips, bungee cords, -Rope or twine -Stakes or tie-downs	-Paper towels & paper towel holder -Wash basin -Buckets -Water dispenser & spigot -Water filter -Bleach -Hand sanitizer -Empty spray bottles	-Soap -Wash cloths, handwipes -Tooth brushes, paste, floss -Shampoo, conditioner -Hairbrush, comb, hair ties -Shaving cream & disposable shavers -Nail clippers & file -Hair sheers, clippers -Maxi pads, tampons -Diapers (adult & baby) -Mirrors

Figure 55: Suggested Sanitation & Hygiene Supplies

A4.1. Temporary Toilets

Temporary restrooms can easily and quickly be set up using a 5-gallon bucket with a toilet seat lid or swimming pool noodle, and a pop-up privacy tent or screen made out of tarps (Figure 56). Additional materials needed include plastic bags, toilet paper, stakes for securing the pop-up tent or rope for hanging tarps. This can be used for temporary toilet needs while people work to set up a short-term waste disposal system.

Toilet paper can be tricky to store in a disaster cache because it can collect moisture. It will need to be inspected regularly and rotated as necessary. See Appendix E for an example of a “Toilet Paper Storage Strategy.”



Figure 56: Temporary Restroom
Photo courtesy of Susan Graves

TIP: HONEY BUCKETS

Many school playgrounds, athletic fields, parks, and other organizations have porta potty units (honey buckets) at their facilities. Check to see if there are any near the disaster cache. They may provide a temporary place for toileting needs while you are constructing waste disposal systems. Knowing this might also help in the decision to store toileting supplies in the cache.

A4.2. Human Waste Disposal

When considering strategies and systems for toileting needs and human waste disposal, be sure to investigate what is feasible and appropriate for your jurisdiction, cache location, and target population. Customize a plan for your unique circumstances and disaster cache mission. Listed below are several different sanitation systems that others have developed or used for their disaster caches.

- ***A Sewer Catastrophe Companion***

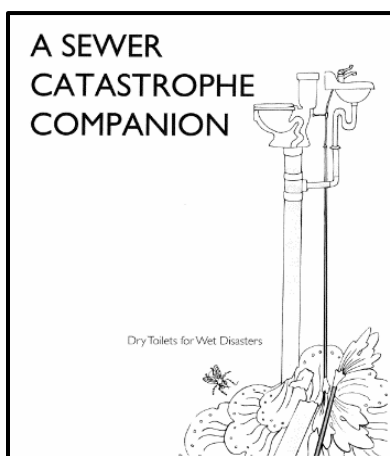

Figure 57: Front Cover of a Sewer Catastrophe Companion

Illustrated by Molly Danielsson

A Sewer Catastrophe Companion is an easy-to-understand guide on how to manage poop and pee safely using 5-gallon buckets (Danielsson & Lippincott, 2012). Instructions are included for 1) a toilet system, 2) a hand washing sink system, and 3) safe waste disposal strategies. It has details for all the supplies needed as well as drawings and instructions on how to prepare the buckets in advance of a disaster. It includes calculations to determine the number of supplies needed based on the number of people expected to serve and for the number of days you expect them to be there. It is an environmentally friendly solution that is easy to follow and set up. This guide includes a useful bibliography for additional research. See the reference in Appendix I.

- ***WaSH (Water, Sanitation & Hygiene)***

The Emergency Volunteer Corps of Nehalem Bay (EVCNB) developed a strategy called [WaSH](#) (Water, Sanitation, & Hygiene). The WaSH system incorporates a water filtration system, sanitation stations, a hygiene station, and water collection teams. It includes an itemized inventory list with practical instructions for setting up each part of the WaSH system. See the *Tillamook County Case Study* in Appendix B for details. The EVCNB also provides a comprehensive training class for their community on how to prepare for and operate the WaSH system in emergencies. See reference in Appendix I.

- **Commode System & Latrine Trench Design**

For those whose target population is mostly retired adults or those with mobility limitations, using buckets for toilets may not be ideal. The *Coastal Cache* team developed a sturdy toileting system using a commode chair (Figure 58) and a unique latrine trench design. This innovative strategy, featured in Appendix E, includes detailed drawings, instructions, and parts list for others interested in replicating their latrine trench system.



Figure 58: Commode Chair

Photo courtesy of Susan Graves

- **Twin Buckets Pee & Poo**

The Seattle Emergency Communications Hubs (2014) put together a 1-page [Sanitation Poster](#) showing a practical and inexpensive temporary system (Figure 59) to manage Pee and Poo and sanitize hands (see Appendix E). The Regional Disaster Preparedness Organization (RDPO) developed a 9-page [Emergency Toilet Guidebook](#) specifically for disasters. Both use a twin bucket system.



Figure 59: Seattle Twin Bucket System

Photo from their Sanitation Poster

- **The Humanure Handbook**

For a more detailed and comprehensive guide to human waste composting, consider keeping a copy of [The Humanure Handbook](#) in the cache (Jenkins, 2019). This book also provides instructions and pictorial guides for constructing creative water collection systems, which are necessary for ongoing sanitation and hygiene needs. There are many other books and resources available on this topic that could also be considered for inclusion in the cache.

TIP: WRITTEN INSTRUCTIONS

Keep easy-to-follow instructions in the cache that explain how to use the items you store for sanitation and hygiene purposes. If you decide not to store supplies for sanitation and hygiene needs, consider at a minimum, storing printed instructions in the cache. This will provide people with information that can empower them to construct their own sanitation and hygiene systems using materials safely salvaged from their own homes.

A4.3. Handwashing

Handwashing is important to prevent the spread of disease. It is needed after using restrooms, in first aid areas, for food prep, before eating, etc. Two ideas are presented below. Both are feasible solutions for temporary handwashing stations.

- **Basic Hand Washing Station**

A simple system featured in *The Seattle Emergency Communications Hubs Sanitation Poster* (see Appendix E), uses inexpensive and basic supplies to accomplish hand sanitation needs. Supplies needed: 5-gallon bucket, empty laundry detergent container with spigot, paper towels, paper towel holder, bungee cord, hand sanitizer, and bleach/water mixture (Figure 60).

- **The Tap Up**

A two-bucket hand sink system is featured in *A Sewer Catastrophe Companion* (Danielsson & Lippincott, 2012). The guide includes a parts list and detailed instructions with pictures for assembling the system in advance of a disaster. It also provides several helpful tips for handling water, where to empty the water, and more.



Figure 60: Basic Handwashing Station
Photo courtesy of Susan Graves

A4.4. Personal Hygiene

A minimum level of personal hygiene will be important during a disaster; not only for health and cleanliness, but also for psychological safety and lifting people's spirits. If you decide to store personal hygiene supplies in the cache, such as soap, tooth brushes/paste, shampoo, grooming supplies, tampons, diapers, wash cloths, etc., be sure to take into consideration the unique needs of your target population. For example, babies may need diapers, women may need tampons, the elderly may need adult disposable underwear. Remember that moisture in the cache can impact the storage of paper supplies.

TIP: HOTELS & DENTAL OFFICES

Hotels and dental offices might be organizations to ask for donations of small personal hygiene items. People who travel often may be willing to collect and donate such items. They can also be found at "dollar" type stores. Consider getting zipper storage bags and creating small hygiene kits that are ready to distribute.

A5. FOOD

- A5.1. Existing Food Supplies**
- A5.2. Pre-packaged Survival Food**
- A5.3. Do-it-Yourself Food Storage**
- A5.4. Living off the Land**
- A5.5. Cooking & Food Distribution Supplies**

A5. FOOD

If your cache mission supports storing food, there are many things to think through in deciding how to balance disaster nutritional needs with long-term safe food storage. In a catastrophic disaster when food supplies are limited, you will have to be creative, disciplined, and strategic about food storage, acquisition, preparation, and distribution. Safety must be a top priority. Refer to FEMA’s “[Food and Water in an Emergency](#)” brochure (Figure 61).

When storing food, it is important to consider factors such as weather, temperature, expiration dates, rotation needs, and liability involved

if someone is harmed from spoiled food. You will also need to consider the dietary needs of your target population. Are there cultural, religious, medical or non-medical food preferences or restrictions? Those could include nut allergies, foods low in sodium, fat, or sugar, gluten-free or dairy-free foods, kosher, vegetarian or vegan diets. Infants and pets will also have unique food needs. All of these things will factor into your food storage choices.



Figure 61: FEMA's Food and Water in an Emergency Brochure

Carefully plan the rationing of food. In a disaster situation you will probably have to think differently about portion size and frequency of meals. Here are some examples of food supplies to consider (Figure 62):

SUGGESTED FOOD & COOKING ITEMS			
FOOD	COOKING STOVES	COOKING SUPPLIES	CLEANING, SERVING
-Survival food bars -MREs -Freeze-dried food -Canned foods -Bulk food stored in food-grade buckets -Coffee -Seasonings -Pictorial foraging guides -Fishing poles, lines, nets -Hunting gear, traps, tools. -Seeds	-Campfire supplies -Camp stoves -BBQ grills -Grill grates -Cook stove & fuel -Propane burner -Propane bottles -Matches -Lighters -Skewers	-Manual can openers -Pots & pans w/lids -Coffee/tea pot, filters -Cast iron pans -Roasting spears & tools -Sharp knives -Serving spoons & forks -Tongs, spatulas -Potholders, aprons -Cutting boards -Zipper bags, plastic wrap, aluminum foil -Coolers -Cookbooks	-Wash cloths, hand towels -Clothesline & pins -Dish soap, bar soap -Dish pans -Rubber gloves -Buckets, wash bins -Spigot -Garbage bags -Plates, bowls, cups, cutlery, napkins -Baby bottles & sipper cups

Figure 62: Suggested Food & Cooking Items

TIP: EXPIRATION DATES

If you decide to store food in the cache, carefully investigate your food selections. Expiration dates matter. If you store food that expires after just a few years, it will need to be rotated out and replaced. Funding can become a significant hurdle. It might be efficacious to cache food with a 20+ year shelf-life.

A5.1. Existing Food Supplies

One of the most important food-related items to store in the cache are written materials that provide instructions for safe food handling in a disaster. Make a written plan for safe handling and use of existing food supplies that may be retrieved with permission from homes, schools, and/or businesses that are safe to enter after a disaster. The plan should include parameters for salvaging food, record keeping, safe handling of food, and distribution. Store printed copies of [“Food and Water in an Emergency”](#) brochures in the languages of your target population for distribution at the cache (FEMA, 2004). The Seattle Emergency Communications Hubs put together a 1-page [Food Poster](#) (See Appendix E) showing essential considerations for existing food supplies in a disaster.

- ***Salvaging Food***

Work with your team to develop a plan for safely salvaging food and supplies. If it is safe for teams to go into buildings (with permission) for very short periods to retrieve food and cooking supplies, teams should wear protective gear such as hard hats, leather gloves, masks, goggles, and whistles, and work within their level of training. Some groups cache this type of protective gear as well as instruction booklets for safe search and rescue operations.

- ***Perishable Foods***

Open refrigeration units as infrequently as possible. Work to make a list of what is inside each unit so you can plan without having to open the units often. Eat perishable foods first.

- ***Canned Foods***

Canned foods typically have a significant amount of water/liquid in them. This can be valuable when water is scarce. Include instructions in your operations manual about food safety such as not eating food from cans that are dented. Be sure to have can openers on hand. If you decide to cache canned foods, know the drawbacks. Canned foods usually have a short shelf-life, often only about two years, so you will have to check dates frequently and rotate them out. If you do not have the capacity for continual inspections and rotations, canned foods might not be a wise choice for the cache.

A5.2. Pre-packaged Survival Food

Pre-packaged survival foods are available in different configurations. There are different foods, storage methods, calorie counts, taste and nutritional value, and shelf-lives ranging from 1 to 30 years. Some require adding water, others require a heat source, and some can be eaten

right out of the package. There are food ration bars, MREs (Meals Ready to Eat), freeze dried foods, and dehydrated foods.

TIP: FOOD STORAGE AND COOL TEMPERATURES

When storing food in a disaster cache, cooler temperatures will help lengthen shelf-life. Store food at temperatures below 70 degrees Fahrenheit if possible.

- ***Food Ration Bars***

Emergency food ration bars typically come in single-serve food bars, or perforated bars of 1200, 2400, or 3600 calories so they can be easily separated and rationed (Figure 63). The survival food bars should have a very tight seal to each package. If the seal is broken (if it appears to have air inside the package), the food is not safe and must be discarded. If the seal is in place and the bar is not expired, it should be safe to eat. If the seal is completely in place yet it is expired, you will have to decide whether or not to eat it. Survival food bars are a practical food choice because they do not require additional water or cooking supplies and they are ready to eat, enabling rapid distribution of food.



Figure 63: Survival Food Bars with Perforation

Photo courtesy of Susan Graves

TIP: CARDBOARD & MOISTURE

Food stored in cardboard can gather moisture. It can attract pests and rodents. Carefully remove sealed food packages out of cardboard storage boxes and place into heavy-duty plastic totes or buckets. Seal the totes or buckets tightly. While there is an added expense in acquiring the totes or buckets, this method will help protect your food supply, and the totes and buckets will come in handy for other needs during a disaster.

- ***MREs (Meals Ready to Eat)***

There are a wide variety of MREs on the market. Some require water, some come with their own cooking devices, others are ready to eat as is. MREs have an expiration date printed on them and will need to be rotated. While it is generally not recommended to eat food beyond its expiration date, survivors may need to make that difficult decision in an extreme situation.

- ***Freeze-Dried & Dehydrated Foods***

Freeze-dried and dehydrated foods are two other options to consider for disaster cache food stockpiling, and are readily available in a wide variety of food products. Freeze-dried foods are

recommended over dehydrated foods for disaster caches because they contain less moisture resulting in a longer shelf-life. However, since water is needed to rehydrate or soften many freeze-dried and dehydrated food products, planning for adequate amounts of water is necessary.

A5.3. Do it Yourself Food Storage

Some groups decide to purchase food in bulk such as beans, grains, oats, rice, pasta, dogfood, etc., and store it in BPA-free food-grade buckets with gamma seal lids, using heat-sealed Mylar bags and/or other methods to remove oxygen and seal the food adequately. If you decide to store food that you prepare yourself, be sure to consult a reputable food preservation and storage guide to learn safe handling, preparation, packaging, and long-term food storage practices. Before deciding to do this, consider the liability involved and any training needed to properly preserve the items and if you need to use a commercial kitchen to do this safely and legally. Check with your local health department or extension service for additional guidance and possible partnerships. Label things carefully, including the contents, date packed, and expiration date.

TIP: FOOD STOCKPILING 101

If you decide to prepare food yourself for the community disaster cache, you might consider taking a course developed by EVCNB called “Household Emergency Food Stockpiling 101.” This practical 2-hour course focuses on households but the concepts are transferrable to larger-scale disaster cache food stockpiling.

A5.4. Living Off the Land

Depending on the cache location and mission, you may determine it is helpful to cache supplies necessary to empower your target audience to harvest food from the land and water. This could include foraging for edible plants, hunting or fishing, or planting fast-growing seeds.

- **Foraging**

Depending on the location of the disaster cache, it may be valuable to have foraging pictorial guides in the cache for edible plants specific to your region (Figure 64). This will equip your target audience with valuable information on the edible foods that may grow near the cache and that might be able to be harvested and eaten. Caution: knowing exactly what you are harvesting when foraging for wild edible foods is critical. Safety is always a priority.

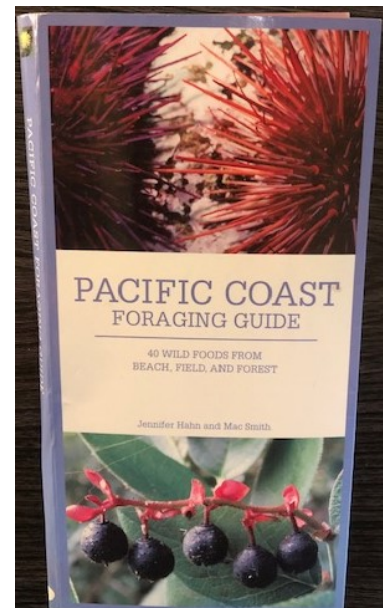

Figure 64: Front Cover of Pacific Coast Foraging Guide (Hahn & Smith, 2010)

Photo courtesy of Susan Graves

- **Hunting and Fishing**

Depending on your location, hunting and fishing may be an option for food acquisition. Beware of fishing in any bodies of water that were contaminated by tsunami inundation, as hazardous materials are likely to be present. If hunting and fishing are part of your disaster cache strategy, determine what kind of gear and supplies will be needed.

- **Seeds**

Consider storing vegetable seeds in the cache. The shelf-life of heirloom seeds can vary between 3-25 years. Some kinds of sprouting seeds can produce vegetable products in less than a week. Most seeds however, take a number of months to grow. Think about your climate, where your target audience will be gathered and sheltering, and for how long you anticipate being there to help determine if caching seeds aligns with your mission. Check with your local extension service or master gardeners for guidance.

A5.5. Cooking & Food Distribution Supplies

Determine what supplies you will need for the practical and operational steps to safely prepare, cook, and distribute food to your target audience, as well as clean up afterwards. A food distribution plan can also be helpful as you work to distribute and ration food equitably and responsibly. The easiest food caching method uses survival food bars that are perforated, since no cooking is required. In this case you might just need knives for cutting them and sandwich bags for separating and distributing them.

- **Camp Stoves**

Outdoor camp stoves can be used for boiling water and cooking food. Some outdoor camp stoves, such as the [Solo Stove](#) and [Stove Tec Biomass Cookstoves](#) (*Sasquatch & BigFoot Cookstoves*), use bio-fuels such as twigs, leaves, pinecones, and wood (Figure 65). Another, the [BioLite CampStove2](#) uses biofuels but also generates electricity to charge phones, lights, and other items. These are handy because they do not require stored fuel. If the cache is in a neighborhood, people may be able to salvage and collect things from their own homes such as backyard fire pits and various BBQ grills or equipment that they may be willing to share.

- **Cooking & Serving Supplies**

If the cache includes foods that require cooking, you will need a supply of pots, pans, cooking utensils, serving ware, and cleaning supplies. Reusable serving ware such as plates, silverware, and coffee mugs will have to be washed after each use, requiring more water. Single-use serving items will create trash and require the need to store larger quantities of single-use serving elements.



Figure 65: Stove Tec Biomass Cookstove
Photo courtesy of Susan Graves

A6. LIGHTING

Since power can be out for extended periods of time in a disaster, considering the many potential needs for lighting is important.

If the cache is designed to support a temporary camp area, then a minimal amount of lighting will be needed for the dark hours. Lighting may also be needed for restrooms, medical treatment areas, meal areas, search and rescue operations, and for general safety purposes. There are a wide variety of lighting choices available and many have solar and LED technology that provide significant hours of lighting.

Here are some examples of lighting supplies to consider (Figure 66):

SUGGESTED LIGHTING ITEMS			
-Solar garden/path lights -Glowsticks	-Flashlights -Headlamps -Lanterns	-LED lights -LED light switches -LED rope lights -LED candles	-Crisco candles (Crisco, wicks, chopsticks) -Utility lamps -Tripod lights

Figure 66: Suggested Lighting Items

A6.1. Lighting Options

Solar garden or path lights may be good lighting options for camp areas because they are inexpensive and store well; however, after storing solar devices in the dark, they will need time to charge once deployed. For tent lighting, LED rope lights, light switches, or lanterns can be useful. Flashlights and head lamps can be helpful for teams heading out of camp on safety related missions. Hand crank flashlights are also an option, however several cache teams reported they lose effectiveness after being stored for long periods of time. Some groups cache large quantities of inexpensive single-use glow sticks for night-light purposes. LED candles can also offer hundreds of hours of soft night lighting.

In general, lighting equipment that can be powered by batteries *and* through charging mechanisms or solar panels are good choices. When batteries run out, charging equipment and solar technology may be able to fill the void to get lighting operational again.

CAUTION: CANDLES

Open-flame candles and lanterns are typically not recommended in an earthquake due to aftershocks and risk of fires. LED candles can last a long time and create a similar effect. Lanterns are readily available with LED, battery, and solar technology. Some planning teams that do decide to use open-flame candles try an innovative long-life candle strategy using cans of Crisco. Tie a knot in the bottom of a candle wick, attach it to a chop stick, and push it down to the bottom of the Crisco can.

A7. POWER

A7.1. Batteries

A7.2. Solar Power

A7.3. Hand-held Power Banks

A7.4. Portable Power Stations

A7. POWER

Power is required for many purposes, and since electricity is expected to be out for an extended period of time in a disaster such as a Cascadia subduction zone earthquake and tsunami, it is an important thing to plan for.

Power might be necessary for lighting, communications, medical devices, cooking equipment, water filtration systems, and search and rescue tools. Power can also charge cell phones; and while cell service may be non-existent or very limited during such a disaster, cell phones may be needed for retrieving critical saved information,

taking pictures, and more.

Here are some examples of power supplies to consider (Figure 67):

SUGGESTED POWER ITEMS		
POWER	MISC SUPPLIES	FUEL
-Batteries -Hand-held power banks -Portable power stations -Solar panels -Generators	-Power strips, extension cords -Charger cables, cords -Car cigarette lighter cords -Car battery cables and clamps -Adapters, connectors -USB cords	-Gas -Propane -Sterno -Siphons -Gas cans

Figure 67: Suggested Power Items

A7.1. Batteries

Consider caching a variety of batteries to support the different equipment you store in the cache. Survivors may also arrive at the cache with their own equipment that will need batteries to continue functioning over time. Batteries take up very little storage space and have a long shelf-life, but need to be rotated. This can be included in your cache maintenance plan.

CAUTION: BATTERY STORAGE

Batteries that correspond with your equipment will be needed. But do not store batteries inside the equipment or they may corrode and ruin the equipment.

A7.2. Solar Power

There are also a wide range of solar power panels and banks to consider. Some are portable and fold into the size of a wallet; others fold into the size of a briefcase. Some have kickstands so they can be positioned to lean toward the sun. Many are compatible with traditional charging cords. Some solar systems are stationary and hardwired to provide power to a

dedicated group of outlets. Others are companions to and designed specifically for use with a portable power station or generator. There is a plethora of solar panels with various features, capacities, ease-of-use, and prices. Note that after storing solar devices in the dark, they will need time to charge once deployed. Check the specifications on solar devices you are considering to determine their stored shelf-life, how long they take to charge, and how long the power lasts once fully charged.

A7.3. Hand-held Power Banks

There are also a variety of hand-held size portable chargers, power banks, and battery packs for cell phones and other small devices to consider caching. Some are strictly for cell phones and other small devices that use USB cords (Figure 68). Other chargers have AC outlet capability too. Some can be recharged using solar technology.

A7.4. Portable Power Stations

A Portable Power Station is a charger device about the size of a car battery (Figure 69). Some have outlets for USB cords to charge cell phones and laptops, 100V/200W AC outlets for typical electric plug-in cords, and even 12v car outlets. They can charge lanterns, cell phones, radios, freezers, and more. Most have inputs so that after they lose their charge, they can be recharged with a solar panel, generator, or through a vehicle cigarette lighter outlet. Power packs and stations have to be charged occasionally (during non-disaster situations just plug them into a normal electrical outlet for charging); and some need regular use, so that will need to be considered in terms of ongoing maintenance. Some come with various sized cords, adapters and connectors. Portable Power Stations are inexpensive and easy to use.



Figure 69: Portable Power Pack by Cen-Tech
Photo courtesy of Susan Graves



Figure 68: NEBO 10,000 mAh Power Bank
Photo courtesy of Susan Graves

A7.5. Generators

There are a variety of generators on the market. Most rely on gas or propane to operate, but others can be charged using solar panels. If you decide to cache generators, think about fuel possibilities and challenges. If you decide to store fuel, you will need to evaluate the added risk due to the potential of spillage and flammability, and plan to rotate the fuel regularly. In either case, you will need to consider caching extension cords and any other necessary generator adapters, cables, and supplies.

TIP: GAS CANS & SIPHONS

If the cache is in a location where residents may be able to siphon fuel from their own vehicles, consider caching empty gas cans, siphoning supplies, and written instructions that include safety precautions.

A8. COMMUNICATIONS

A8.1. At the Cache

A8.2. Near the Cache

A8.3. Outside the Area

A8.4. Emergency Officials

A8.5. Signaling Devices

A8. COMMUNICATIONS

There are many factors to think about regarding communications in a disaster. Consider coordinating this part of your disaster cache planning with your local emergency managers, fire department, and/or any amateur radio groups that serve your region.

If addressing communications needs is part of your cache mission, here are some possible focus areas (Figure 70).

SUGGESTED COMMUNICATIONS ITEMS			
RADIOS & PHONES	WARNING & ATTENTION-GETTERS	GUIDES	MISC.
-AM/FM radios -NOAA Weather Alert Radio -Two-way radios (walkie-talkies) -Ham radio or CB radios -Satellite phones -Cell phones -Landline phones	-Bullhorn, megaphones, whistles, air horns -Signaling devices & mirrors -SOS flags -Flare guns & flares -Orange fluorescent paint -Caution tape	-Instruction manuals -Radio channel & frequency guides -Phone numbers -Signaling symbols & instructions	-Batteries & chargers -Charging cradles -Cords, cables -Bulletin board, white board, chalk board -Paper, pens, pencils -Push-pins, clips

Figure 70: Suggested Communications Items

A8.1. At the Cache

Start with a plan and equipment for how to share information with the people who gather at the cache during a disaster. This could include items such as bull horns, mega phones, or bulletin boards.

A8.2. Near the Cache

Another focus could involve strategies for communicating with people sent on missions near the cache area such as search and rescue teams, water collection teams, or food salvaging teams. Inexpensive two-way radios or walkie-talkies could meet this need (Figure 71); as could notepads and pens, along with runners to deliver messages.



Figure 71: GMRS/FRS Walkie Talkies, CB Radio, and NOAA Weather Alert Radio

Photo courtesy of Susan Graves

8.3. Outside the Area

Third, you may decide to store AM/FM radios or a NOAA Weather Alert Radio to receive information from official outside sources. The ability to hear information from outside the isolated disaster area can provide great comfort and important information to survivors. For coastal communities, a CB radio can be helpful to communicate with marine resources as they become available (Figure 71).

A8.4. Emergency Officials

Next, the cache could include instructions and equipment for establishing communications with emergency officials who are in your community but from whom you are separated due to the disaster. This could involve a local fire department or emergency management agency storing their radio equipment in the cache. Or, at a minimum, a list of their radio frequencies and/or satellite phone numbers could be included in the cache. Amateur Radio (ham radio), along with a list of local ham radio operators and frequencies could also be helpful.

A8.5. Signaling Devices

Finally, the cache could include a plan for how to perform signaling and warning actions. This could be accomplished using SOS or signaling flags (Figure 72), flare guns, or orange fluorescent paint for identifying a helicopter landing area. This type of plan and equipment could be particularly important for isolated rural areas.

Communications equipment will need to be added to your maintenance and inspection plan. Keep instruction manuals with the equipment. Temperature controlled caches may be ideal for storing electronic communications equipment. Another strategy is to plan for people arriving at the cache with their own radios and electronic equipment. The cache would simply store a quantity of batteries of various sizes, along with frequency and channel guides.

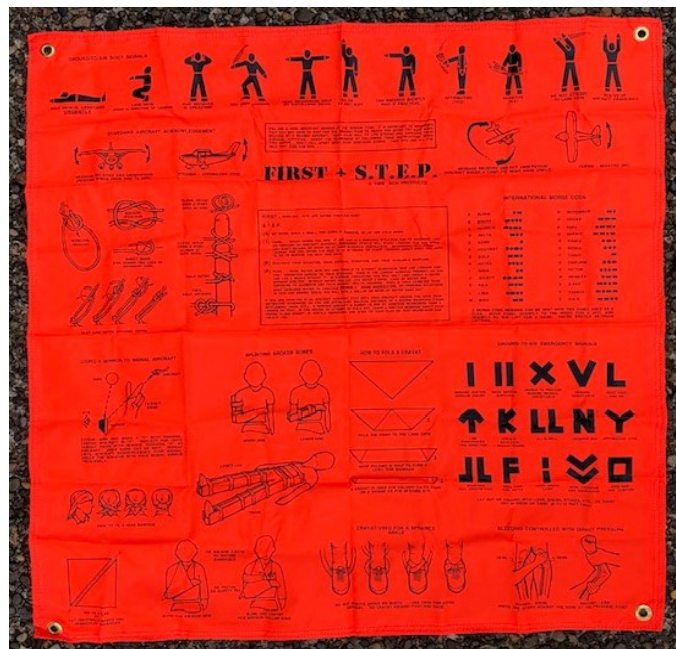

Figure 72: Example of 3 Square Foot Signaling Flag with Survival Instructions, BCN Products, 1989.

Photo courtesy of Susan Graves

A9. MEDICAL

A9.1. First Aid Kits

A9.2. Medicine

A9.3. Disaster Medical Supplies

A9. MEDICAL

After a large earthquake or other major disaster, it is expected that some people will have injuries. If you decide to store medical supplies in the cache, think about the cache location and target population. Do you anticipate trained [Community Emergency Response Team \(CERT\)](#) members arriving at the cache? If so, are they likely to have their own CERT kits and medical supplies or will they have to leave them behind? Do medical professionals live or work near the cache that might be

able to provide some help and expertise if there are supplies in the cache?

Some neighborhood caches collect gently used walkers, crutches, and canes to store in their cache for disaster use as well as for temporary emergency use for their community needs. Remember that some medical supplies are susceptible to collecting moisture and some have a limited shelf-life and will need to be rotated out regularly. Work to customize the cache medical supplies according to your mission, budget, and unique situation. Check with your local fire department, ambulance service, or healthcare facilities for guidance and possible partnerships.

Here are some examples of medical supplies to consider (Figure 73):

SUGGESTED MEDICAL ITEMS		
BASIC SUPPLIES	DISASTER MEDICAL	EQUIPMENT
<ul style="list-style-type: none"> -PPE: gloves, masks, goggles -First aid books -Band aids -First aid kits -Multi-person trauma medical kits -EMT kits -Duct tape & sharpie -Bio-hazard bags or plastic bags 	<ul style="list-style-type: none"> -Bandaging: gauze, tape, bandages, sponges, trauma sheers -Wound prep: alcohol preps, burn dressing, cold compresses -Mylar blankets -Splinting: triangle bandages & Sam Splints, C-Collar 	<ul style="list-style-type: none"> -Stretchers: mega movers, wooden, flexible, cloth -Backboards -Walkers, crutches, canes -Triage tarps & tape or tags -Body bags (see A12 Morgue section)

Figure 73: Suggested Medical Items

A9.1. First Aid Kits

Pre-made first aid kits come in a variety of sizes and have different functions. Some are very basic and inexpensive personal first aid kits, others are more robust and designed for office buildings, and some are more specifically oriented towards survival first aid gear. The American Red Cross provides information about what to include in [family first aid kits](#). This information may be helpful as a starting place for considering items for a community disaster cache. The *Coos Bay Disaster Cache Team* established customized first aid kits for their standalone disaster caches (see Appendix F). There are also more extensive and expensive 100-person to 1000-

person trauma medical kits for experienced medical personnel needing to serve a larger population.

TIP: FIRST AID BOOK

At a minimum, consider keeping a first aid book and some band aids in the cache. The first aid book will provide valuable information as people work to use available resources to try to meet medical needs. The band aids will provide some initial comfort, especially for children.

A9.2. Medicine

If over-the-counter medicines such as aspirin, ibuprofen, acetaminophen, and cough medicine are cached, they will need to be rotated.

A9.3. Disaster Medical Supplies

Some groups cache disaster medical supplies that are aligned with [CERT](#) operations. These could include basic Personal Protective Equipment (PPE) such as medical gloves, masks, and goggles, supplies for bandaging and splinting, as well as Mylar blankets for keeping people warm. This could also include equipment like stretchers, backboards, triage tarps and tape.

TIP: EXPIRATION DATES

Many commonly used basic medical supplies have a shelf-life and expire. Because of this, some cache teams have been able to obtain donations of used or expired items from local hospitals such as sheets, blankets, gowns and expired gauze, tape, and gloves. If stored properly, these may still be usable in a disaster situation.

A10. SEARCH & RESCUE

A10.1. Personal Protective Equipment (PPE)

A10.2. Tools, Supplies, & Equipment

A10. SEARCH & RESCUE

Past disasters have clearly demonstrated that in critical emergency situations, such as large earthquakes, people will immediately jump in and try to help rescue others. Having the supplies and equipment necessary to do this safely can help prevent additional injuries and death, and may help save lives.

If search & rescue is part of your cache mission, there are a variety of things to consider. Will the target audience be a general population with little or no search and rescue training? Do you expect to have a number of trained CERT members to assist at the cache, or is your plan to cache supplies for professional fire fighters? Think about your mission, target audience, and the condition you expect things to be in near the cache location.

Here are some examples of search and rescue supplies to consider (Figure 74):

SUGGESTED SEARCH & RESCUE ITEMS		
PPE	TOOLS	SUPPLIES & EQUIPMENT
<ul style="list-style-type: none"> -Hardhats with chin strap -Work gloves & medical gloves -Dust masks & goggles -Whistle -Headlamps & flashlights -Reflective vests or jackets -Work boots & boot covers -Rain gear 	<ul style="list-style-type: none"> -Non-spark multi-tool -Pry bars & crow bars -Axe, hatchet, box cutters, knives, & scissors -Hammers, screwdrivers, & wrench -Bolt cutters & pipe cutter -Sledge hammer -Chain saw -Cribbing, fulcrum, & lever 	<ul style="list-style-type: none"> -Tape: caution tape, duct tape, & masking tape -Fire extinguishers, buckets, shovels, & hoses -Wheel barrows, wagons, buckets -Rope, twine, bungee cords, paracord, zip ties, & carabiner clips -CERT guides, write in the rain books, & writing instruments

Figure 74: Suggested Search & Rescue Items

A10.1. Personal Protective Equipment (PPE)

Some groups store their CERT backpacks full of PPE and gear in their disaster caches. Others customize according to their needs and budget. Leather gloves or work gloves are a must for search and rescue, as is head protection such as hard hats with chin straps. Some groups may decide to cache bike helmets or rock-climbing helmets instead of hardhats because people are more familiar with how to wear them and they are easier to quickly put on and keep securely in place. Check with your local emergency service partners to help determine what is appropriate for the intended purpose. Other typical search and rescue PPE include dust masks, goggles, whistles, flashlights, and reflective vests. The goal is to work to keep rescuers safe as they work to save lives and mitigate damage.

A10.2. Tools, Supplies, & Equipment

Tools can come in handy in a disaster for all kinds of purposes, including search and rescue. A common search and rescue tool for amateurs include a non-spark 4-in-1 emergency tool for gas and water shut-off (Figure 75). Prybars, axes, fire extinguishers, and cribbing are also commonly used in search and rescue operations. Shovels and buckets may be used for moving debris. Some groups even decide to cache chain saws. Other items that can come in handy include duct tape, caution tape, and rope.



Figure 75: Non-Spark Emergency Tool

Photo Courtesy of Susan Graves

A11. COMFORT

A11.1. Reading & Writing

A11.2. Games & Toys

A11.3. Warmth

A11.4. Disaster Psychology

A11. COMFORT

Disasters can be traumatic and cause mild to extreme stress in survivors. Situations where people are separated from and cannot exchange information with loved ones can cause additional stress. There may be a lot of waiting time from the onset of the disaster to when survivors are relocated to a more stable and permanent location. Fear of the unknown can escalate anxiety.

If the cache mission includes addressing *comfort* for your target population think about their needs, how long you expect them to need the items, and what is feasible to

store in the cache. If the cache building is not temperature controlled, examine how moisture may influence your selection of comfort items.

Here are some examples of comfort supplies to consider (Figure 76):

SUGGESTED COMFORT ITEMS				
READING	WRITING	GAMES & TOYS	MISC	WARMTH
-Reading glasses	-Coloring books & crayons	-Cards & dice games	-Pacifiers	-Hand & foot warmers
-Books & magazines	-Drawing paper & colored pencils	-Board games	-Teething toys	-Mittens
-Inspirational materials	-Notepads & writing utensils	-Crossword & Sudoku books	-Glow sticks	-Scarves
-Calendars	-Sidewalk chalk	-Stuffed animals	-Kids band aids	-Stocking hats
-Self-care information	-Message board	-Toddler toys	-Hygiene kits	-Socks
-Magnifying glass	-Pencil sharpener	-Puzzles	-Harmonica	-Fleece blankets
				-Hot coffee, tea, chocolate, cider

Figure 76: Suggested Comfort Items

A11.1. Reading & Writing

Reading materials could be on topics related to survival, self-care strategies, inspirational stories, or entertainment. Writing materials could include coloring books and crayons, notepads and pens/pencils, sidewalk chalk for children, and items for a message board where information can be posted and shared.

A11.2. Games & Toys

Small, easy-to-store activities, games, and toys for various age groups can be helpful comfort items, especially if your target population will be at the gathering area for an extended period of time. Pacifiers and teething toys for youngsters can be particularly helpful and a great quieting tool. Instructions and/or rule books for games can also be helpful and reduce conflict.

TIP: GLOW STICKS

Glow stick necklaces and bracelets are like night-lights for children and can reduce anxiety and improve physical and psychological safety. They are very inexpensive at dollar-type stores and have long shelf-lives. They are single-use items in terms of light; however, children can still play games with them once they run out of light.

A11.3. Warmth

Staying warm provides comfort and can reduce anxiety. Hand warmers and foot warmers are great comfort items and can be stored in caches without collecting moisture, though they are single-use only. Having a hot or warm beverage to cradle in your hands and sip on can elicit a comforting and calming effect. Be careful with large amounts of caffeine as that can work against calming strategies. Be sure to consider moisture if you decide to cache cloth items such as hats, gloves, socks, or stuffed animals. (See section A3 for more about warmth.)

A11.4. Disaster Psychology

Consider including printed information in the cache operations manual about how to talk with people going through disasters. The CERT program has a unit on [Disaster Psychology](#) along with a [training video](#) and includes some helpful information. Topics dealing with grief, trauma, loss, as well as hope, self-care, and coping strategies could be appropriate and helpful.

Some strategies to improve mental health for survivors include: 1) establish routines that provide predictability around camp; 2) give people jobs; and 3) encourage personal hygiene (like teeth brushing and face washing).

A12. MORGUE

A12.1. Basic Morgue Planning

A12.2. Morgue Protocols

A12. MORGUE

Under normal circumstances, there are laws and processes that formally trained professionals follow when someone has died. Lay people do not deal with the deceased in regular life. But when planning for a catastrophic disaster like a large Cascadia earthquake and tsunami, some groups recognize a need to have some information and/or supplies in their cache to help deal with those who have died as a result of the disaster.

Here are examples of morgue supplies to consider (Figure 77):

SUGGESTED MORGUE ITEMS			
STORAGE & SET-UP	WRAPPING SUPPLIES	DOCUMENTATION	PPE & SANITATION
-Storage trunk & lock -Tent canopy -Tarps -Partitions (shower curtains, sheets, or tarps) -Rope & zip ties -Lighting	-Blankets or sturdy sheets -Clear plastic bags -Contractor construction bags or body bags -Roll of plastic sheeting -Duct tape -Strips of cloth for wrapping.	-Office: Clipboards, pens, paper, sharpie, scissors, masking tape -Forms: Morgue tracking forms, Victim identification forms -Wrist/ankle tags	-PPE: medical gloves, masks, goggles, infection control gowns, & shower caps -Kleenex, hand sanitizer, hand wipes, & wash cloths -Garbage cans, buckets, & plastic liners -Bottled water

Figure 77: Suggested Morgue Items

A12.1. Basic Morgue Planning

Some groups decide to have a stock of body bags in their disaster cache. Others have instructions and supplies for establishing a temporary morgue. This can be particularly important for groups who anticipate being isolated during a catastrophic disaster and without access to professional responders. In this case, having clear guidelines for a temporary morgue can help survivors handle the dead in a safe, respectful, and organized manner. This can also help prevent the spread of disease and improve the psychological health of survivors.

A12.2. Morgue Protocols

Two groups developed written protocols to deal with this difficult situation (see Appendix H). The first was developed for a CERT group and is called, *CERT Morgue Protocols for Isolated Rural Communities during a Catastrophic Disaster*. It identifies a process for establishing a temporary morgue and includes protocols for logistics, morgue set-up, body processing, body disposition, documentation, demobilization, and details about the morgue supply kit. The second, the Joyce Planning Team, developed a *Mortuary Plan* that is incorporated into their disaster cache supplies and instructions. It explains the specific circumstances and conditions that must be met to enact the plan, including corresponding references.

A13. MISCELLANEOUS

A13.1. Clean up Supplies

A13.2. Animals & Pets

A13.3. Security

A13.4. Traffic Control

A13.5. Transportation

A13. MISCELLANEOUS ITEMS

There are other potential categories to support various disaster cache missions, such as clean-up supplies, items for animals and pets, security considerations, transportation items, and traffic control supplies. Individual planning team may identify additional categories of supplies for their cache.

Here are some suggested supplies from others who have developed caches (Figure 78):

SUGGESTED MISCELLANEOUS ITEMS				
CLEAN UP	ANIMALS & PETS	SECURITY	TRANSPORTATION	TRAFFIC CONTROL
-PPE: hardhats with chin strap, masks, goggles, leather gloves, & work boots -Shovels: flat & pointed -Brooms -Construction bags & buckets -Plastic sheeting -Staple gun & staples	-Collars, harnesses, soft muzzles -Leashes, cable line, carabiner clips -Collapsible carriers & crates -ID tags -Blankets, bedding -Food, water, & bowls -Toys, balls -Litter box, litter, scoop, & plastic bags	-Padlocks or combination locks -Safe or lockable trunk -Zip ties -Bear spray -Bee spray -Air horns	-Small boats or life rafts -ATV or golf cart -Bikes, wagons, & strollers -Stretchers -Walkers, canes, or crutches	-Traffic cones with LED lights -Traffic safety wands -LED batons -Sandwich boards with solar lights -Caution tape -Handheld paddle signs -Safety flags -Reflective vests -Solar road flares

Figure 78: Suggested Miscellaneous Items

A13.1. Clean up Supplies

Some caches store equipment and supplies for clean-up operations. For instance, in a large earthquake, we can expect windows to break, leaving buildings exposed to weather and rodents. If it is safe to get back into one’s home, securing plastic sheeting over the windows can help close the space and keep rain out. Further, scooping up broken glass with flat shovels, and sweeping up debris and depositing it into contractor construction bags, can go a long way to cleaning up a potential shelter once aftershocks subside.

A13.2. Animals & Pets

People may arrive at the cache with their pets. Conversely, pets or stray animals may arrive at the cache without owners. You may want to consider storing some basic pet supplies to help manage and care for any pets or animals. Depending on the items stored, some may need to be rotated when they reach their expiration date. Refer to [Ready.gov/pets](https://www.ready.gov/pets) for information on

preparing pets for disasters. Consult with your local animal shelter or veterinarians to see how your disaster cache efforts may become part of a larger plan or if they can offer support and training to your team.

A13.3. Security

If the cache mission includes setting up a temporary encampment, you may want to consider how to secure the cache supplies for distribution as outlined in your operations plan. You might also want to have some protective items in case wild animals wander into your camp, such as bear spray. Consult with your local law enforcement agency for guidance.

A13.4. Transportation

Some caches are strictly designed for very temporary relief until the target population can relocate to a more permanent location. In this case, some caches include various modes of basic transportation such as small life rafts or boats, bikes, wagons, and strollers.

A13.5. Traffic Control

Simple traffic control items can be useful in a variety of situations. Traffic cones with night LED lights, caution tape, and reflective vests are some of the basics.

A14. SUGGESTED SUPPLIES & EQUIPMENT

This section displays all of the tables of suggested disaster cache supplies and equipment featured in Appendix A.

SUGGESTED WATER ITEMS			
STORAGE	COLLECTION	PURIFYING	DISTRIBUTING
<ul style="list-style-type: none"> -Bottled water -Packaged water -Water storage containers -55-gallon barrels with bung wrench, hand pump, & purifier solution 	<ul style="list-style-type: none"> -Water collection containers (jugs, buckets & lids) -Water heater siphon & instructions -Gutter downspout diverter & spigot -Tarps -Bungie cords 	<ul style="list-style-type: none"> -Strainers, coffee filters -Water filtration or purification systems -Water filter straws or bottles -Non-scented bleach -Measuring cup -Water purification tablets or drops -Water purifying brochures -Pans for boiling water -Fire making materials 	<ul style="list-style-type: none"> -Funnel -Hand pump -Cups -Collapsible water bottles -Hand truck -Buckets

SUGGESTED SHELTER ITEMS			
SHELTER/TENTS	TIE-DOWNS	SET-UP	MISC
<ul style="list-style-type: none"> -Tarps -Pop-up canopies -Camping tents -High-capacity tents -Plastic shower curtains -Plastic sheeting (Visqueen) 	<ul style="list-style-type: none"> -Rope, paracord, tie-downs, bungee cords -Carabiner clips, zip ties -Stakes, spike nails -Hammer or rubber mallet -Sandbags and shovels -Orange flagging tape -Tennis balls, pool noodles 	<ul style="list-style-type: none"> -Step stools -Furniture moving straps -Waterproof Seal -Identification tags -Labels or signs for tents -Sharpies -Scissors or knife 	<ul style="list-style-type: none"> -Tent assembly instructions -Tie-down strategies -Laminated tarp shelter plans -Camp organization diagrams -Knot-tying instructions -Tent assignment forms -Plastic storage totes -Moisture absorbent packets

SUGGESTED WARMTH ITEMS			
STAYING DRY & WARM	CLOTHING	FIRE STARTERS	MISC
<ul style="list-style-type: none"> -Tarps -Plastic shower curtains -Plastic sheeting -Mylar blankets -Cloth or wool blankets -Sleeping bags -Cots & mattress pads 	<ul style="list-style-type: none"> -Rain ponchos or rain gear -Coats -Hats, scarves, ear muffs -Socks & gloves -Hand & foot warmers -Clothes lines & pins 	<ul style="list-style-type: none"> -Fire starter materials & instructions -Lighters -Fine steel wool -Lint/toilet paper rolls, & votive candles -Flint & steel -Magnifying glass -Waterproof matches 	<ul style="list-style-type: none"> -Buckets/totes for gathering fire-making supplies -Hatchets, knives -Camp grill grates

SUGGESTED SANITATION & HYGIENE ITEMS			
TOILET	PRIVACY	WASHING	PERSONAL HYGIENE
-5-gallon buckets & lids -Toilet seat or pool noodles -Commode, urinal, bedpans -Heavy-duty trash bags -Toilet paper -Scoops, hand shovels -Pails, buckets -Filler: cat litter, shredded paper, saw dust, lime -Gloves	-Pop-up privacy tent -Tarps, plastic sheeting, or plastic shower curtains -Clothes line and pins -Carabiner clips, bungee cords, -Rope or twine -Stakes or tie-downs	-Paper towels & paper towel holder -Wash basin -Buckets -Water dispenser & spigot -Water filter -Bleach -Hand sanitizer -Empty spray bottles	-Soap -Wash cloths, handwipes -Tooth brushes, paste, floss -Shampoo, conditioner -Hairbrush, comb, hair ties -Shaving cream & disposable shavers -Nail clippers & file -Hair sheers, clippers -Maxi pads, tampons -Diapers (adult & baby) -Mirrors

SUGGESTED FOOD & COOKING ITEMS			
FOOD	COOKING STOVES	COOKING SUPPLIES	CLEANING, SERVING
-Survival food bars -MREs -Freeze-dried food -Canned foods -Bulk food stored in food-grade buckets -Coffee -Seasonings -Pictorial foraging guides -Fishing poles, lines, nets -Hunting gear, traps, tools. -Seeds	-Campfire supplies -Camp stoves -BBQ grills -Grill grates -Cook stove & fuel -Propane burner -Propane bottles -Matches -Lighters -Skewers	-Manual can openers -Pots & pans w/lids -Coffee/tea pot, filters -Cast iron pans -Roasting spears & tools -Sharp knives -Serving spoons & forks -Tongs, spatulas -Potholders, aprons -Cutting boards -Zipper bags, plastic wrap, aluminum foil -Coolers -Cookbooks	-Wash cloths, hand towels -Clothesline & pins -Dish soap, bar soap -Dish pans -Rubber gloves -Buckets, wash bins -Spigot -Garbage bags -Plates, bowls, cups, cutlery, napkins -Baby bottles & sipper cups

SUGGESTED LIGHTING ITEMS			
-Solar garden/path lights -Glowsticks	-Flashlights -Headlamps -Lanterns	-LED lights -LED light switches -LED rope lights -LED candles	-Crisco candles (Crisco, wicks, chopsticks) -Utility lamps -Tripod lights

SUGGESTED POWER ITEMS		
POWER	MISC SUPPLIES	FUEL
-Batteries -Hand-held power banks -Portable power stations -Solar panels -Generators	-Power strips, extension cords -Charger cables, cords -Car cigarette lighter cords -Car battery cables and clamps -Adapters, connectors -USB cords	-Gas -Propane -Sterno -Siphons -Gas cans

SUGGESTED COMMUNICATIONS ITEMS			
RADIOS & PHONES	WARNING & ATTENTION-GETTERS	GUIDES	MISC.
<ul style="list-style-type: none"> -AM/FM radios -NOAA Weather Alert Radio -Two-way radios (walkie-talkies) -Ham radio or CB radios -Satellite phones -Cell phones -Landline phones 	<ul style="list-style-type: none"> -Bullhorn, megaphones, whistles, air horns -Signaling devices & mirrors -SOS flags -Flare guns & flares -Orange fluorescent paint -Caution tape 	<ul style="list-style-type: none"> -Instruction manuals -Radio channel & frequency guides -Phone numbers -Signaling symbols & instructions 	<ul style="list-style-type: none"> -Batteries & chargers -Charging cradles -Cords, cables -Bulletin board, white board, chalk board -Paper, pens, pencils -Push-pins, clips

SUGGESTED MEDICAL ITEMS		
BASIC SUPPLIES	DISASTER MEDICAL	EQUIPMENT
<ul style="list-style-type: none"> -PPE: gloves, masks, goggles -First aid books -Band aids -First aid kits -Multi-person trauma medical kits -EMT kits -Duct tape & sharpie -Bio-hazard bags or plastic bags 	<ul style="list-style-type: none"> -Bandaging: gauze, tape, bandages, sponges, trauma sheers -Wound prep: alcohol preps, burn dressing, cold compresses -Mylar blankets -Splinting: triangle bandages & Sam Splints, C-Collar 	<ul style="list-style-type: none"> -Stretchers: mega movers, wooden, flexible, cloth -Backboards -Walkers, crutches, canes -Triage tarps & tape or tags -Body bags (see A12 Morgue section)

SUGGESTED SEARCH & RESCUE ITEMS		
PPE	TOOLS	SUPPLIES & EQUIPMENT
<ul style="list-style-type: none"> -Hardhats with chin strap -Work gloves & medical gloves -Dust masks & goggles -Whistle -Headlamps & flashlights -Reflective vests or jackets -Work boots & boot covers -Rain gear 	<ul style="list-style-type: none"> -Non-spark multi-tool -Pry bars & crow bars -Axe, hatchet, box cutters, knives, & scissors -Hammers, screwdrivers, & wrench -Bolt cutters & pipe cutter -Sledge hammer -Chain saw -Cribbing, fulcrum, & lever 	<ul style="list-style-type: none"> -Tape: caution tape, duct tape, & masking tape -Fire extinguishers, buckets, shovels, & hoses -Wheel barrows, wagons, buckets -Rope, twine, bungee cords, paracord, zip ties, & carabiner clips -CERT guides, write in the rain books, & writing instruments

SUGGESTED COMFORT ITEMS				
READING	WRITING	GAMES & TOYS	MISC	WARMTH
-Reading glasses -Books & magazines -Inspirational materials -Calendars -Self-care information -Magnifying glass	-Coloring books & crayons -Drawing paper & colored pencils -Notepads & writing utensils -Sidewalk chalk -Message board -Pencil sharpener	-Cards & dice games -Board games -Crossword & Sudoku books -Stuffed animals -Toddler toys -Puzzles	-Pacifiers -Teething toys -Glow sticks -Kids band aids -Hygiene kits -Harmonica	-Hand & foot warmers -Mittens -Scarves -Stocking hats -Socks -Fleece blankets -Hot coffee, tea, chocolate, cider

SUGGESTED MORGUE ITEMS			
STORAGE & SET-UP	WRAPPING SUPPLIES	DOCUMENTATION	PPE & SANITATION
-Storage trunk & lock -Tent canopy -Tarps -Partitions (shower curtains, sheets, or tarps) -Rope & zip ties -Lighting	-Blankets or sturdy sheets -Clear plastic bags -Contractor construction bags or body bags -Roll of plastic sheeting -Duct tape -Strips of cloth for wrapping.	-Office: Clipboards, pens, paper, sharpie, scissors, masking tape -Forms: Morgue tracking forms, Victim identification forms -Wrist/ankle tags	-PPE: medical gloves, masks, goggles, infection control gowns, & shower caps -Kleenex, hand sanitizer, hand wipes, & wash cloths -Garbage cans, buckets, & plastic liners -Bottled water

SUGGESTED MISCELLANEOUS ITEMS				
CLEAN UP	ANIMALS & PETS	SECURITY	TRANSPORTATION	TRAFFIC CONTROL
-PPE: hardhats with chin strap, masks, goggles, leather gloves, & work boots -Shovels: flat & pointed -Brooms -Construction bags & buckets -Plastic sheeting -Staple gun & staples	-Collars, harnesses, soft muzzles -Leashes, cable line, carabiner clips -Collapsible carriers & crates -ID tags -Blankets, bedding -Food, water, & bowls -Toys, balls -Litter box, litter, scoop, & plastic bags	-Padlocks or combination locks -Safe or lockable trunk -Zip ties -Bear spray -Bee spray -Air horns	-Small boats or life rafts -ATV or golf cart -Bikes, wagons, & strollers -Stretchers -Walkers, canes, or crutches	-Traffic cones with LED lights -Traffic safety wands -LED batons -Sandwich boards with solar lights -Caution tape -Handheld paddle signs -Safety flags -Reflective vests -Solar road flares

CASE STUDIES

- B1. Berkeley (CA)
- B2. Coastal Cache (OR)
- B3. Coos Bay (OR)
- B4. Eagles Nest (OR)
- B5. Eastside CERT (OR)
- B6. Gearhart (OR)
- B7. Joyce (WA)
- B8. Lincoln County Schools (OR)
- B9. Safe Haven Hill (OR)
- B10. Seaside (OR)
- B11. Tillamook County (OR)

APPENDIX B: CASE STUDIES

Overview: This section features 11 Case Studies showcasing different community disaster cache projects, each customized to meet their specific goals and unique community situations.

The first page of each case study gives an overview of the cache. The second page highlights something important or unique about that particular cache such as keys to success, lessons learned, innovative strategies, cache contents, photographs or drawings, or other interesting components worth considering.

The case studies provide a high-level overview of each disaster cache project. Detailed plans from several of the case studies are located in the ensuing appendices.

Each Case Study is an example of one of the Community Disaster Cache *Models* identified in Step 1 of the *Planning Guide*:

- *Standalone Disaster Cache*: Coastal Cache, Coos Bay, Eagles Nest, Eastside CERT, Joyce, Lincoln County Schools, and Safe Haven Hill.
- *Storage for Residents' Supplies*: Gearhart.
- *Dispersed Supplies*:
 - ♦ *Conveyed to a Specific Group*: Berkeley and Tillamook County.
 - ♦ *Stored in Residents' Homes*: Seaside.

Lessons gleaned from these projects may be used to inform new cache projects or strengthen existing projects, as groups work to customize their caches to meet their specific mission, capabilities, and unique conditions.

Note: We have changed the names or locations of some of the cache examples at the request of case study participants due to security or confidentiality reasons.

CASE STUDY B1: BERKELEY

CITY OF BERKELEY COMMUNITY EMERGENCY SUPPLY PROGRAM

The City of Berkeley’s innovative “[Community Emergency Supply Program](#)” is designed, through an application process, to provide a free cache of emergency equipment for neighborhoods or community groups/organizations who demonstrate that they meet specific requirements of being a “disaster resistant neighborhood or organization.”

The program is part of a broader effort of the city to prepare its neighborhoods to be self-sufficient for five to seven days during a disaster, such as a catastrophic earthquake. Their primary aim is to foster awareness and for neighbors and community organizations to attain a minimum level of readiness.

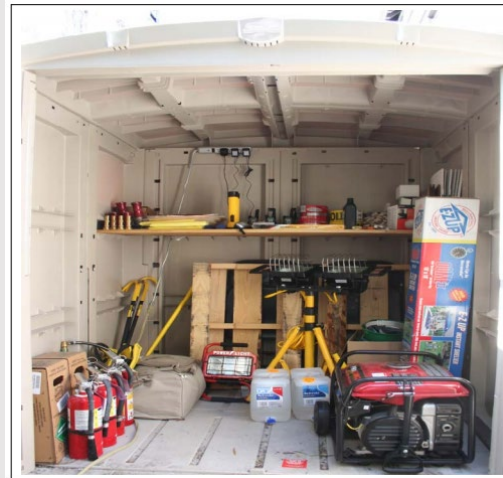

Project Coordination & Authority	The program belongs to the Special Operations Division of the City of Berkeley Fire - Department. This division leads the CERT program and coordinates the Community Emergency Supply Program.
Purpose	The primary purpose is to provide backup emergency equipment to serve the greatest number of residents in the event of an emergency/disaster. The focus is on basic medical, search & rescue, light fire suppression, and other supplies necessary for citizen disaster response efforts.
Target Population	The target population is neighborhoods or other community groups in the City of Berkeley that meet qualifying criteria such as: 1) demonstrate organization and sustainability, 2) meet six of the nine steps of becoming a disaster resistant neighborhood or group, and 3) has at least eight people trained and formed into CERT Disaster Medical Operations, Fire Safety, and Light Search & Rescue Teams.
Model	<i>Dispersed Supplies: Conveyed to a Specific Group</i>
Ownership & Maintenance	Once conveyed to the neighborhood/group, the storage shed and contents are owned by the hosting neighborhood/group. The neighborhood/group maintains the shed and supplies, including efforts to avoid problems like leakage and pests.
Funding	Using a local fire and disaster preparedness tax, the City of Berkeley provides qualified neighborhoods or groups with a FREE cache of emergency supplies. The City of Berkeley aims to ready approximately 10 neighborhoods or organizations and distribute 10 caches each year. Their budget is \$120,000 annually.
Location	Each neighborhood/group provides a secure site for the storage shed.
Storage Building & Security	The City provides a storage shed/container with a combination padlock to house the emergency supplies. The neighborhood/group is responsible to secure the container and supplies from theft and damage with the best efforts practical. The neighborhood/group is responsible for replacing supplies that are damaged or lost due to theft.
Contents	The City provides a basic allotment of supplies as noted on the next page. Caches are customized depending on the neighborhood or community group needs. The receiving organization can add to their cache.
Deployment	Each neighborhood/group makes its own deployment and operating plans.

B1: CITY OF BERKELEY COMMUNITY EMERGENCY SUPPLY PROGRAM

Keys to Success/Innovative Strategies:

- **Application & Letter of Understanding:** On the [City's website](#) are clearly spelled out expectations and a process to qualify, apply for, and become a recipient of one of their disaster caches. The application form and a letter of understanding can be found in Appendix D.
- **Training:** When the cache is being delivered to the qualified neighborhood or community group, a team from the Fire Department brings the supplies, sets them up, and trains the recipients on how to use them, including how to operate the generator. After delivery and setup, the cache recipients take over ownership and operation of their new cache.

Lessons Learned:

- **Target Audience Shifted:** When the City first started, the focus was entirely on neighborhood preparedness and getting neighborhoods trained in CERT and equipped with disaster caches. Over time, they found that mostly higher-income neighborhoods participated in the program. As a result, they expanded their focus and reached out directly to community groups and organizations, apartment complexes, and housing authorities. Their message was, *we will train your staff and give you a cache of supplies for the people who already come to or live in your community.* With a positive response to this new strategy, the City of Berkeley now customizes the supplies they include in the cache to meet the needs of each unique community or group.
- **Storage Shed:** They offer each eligible organization a choice of a small or large storage shed. This gives the community group an option based on the space they have available. Some decline the offer of a shed and arrange for their own storage building or space.



Outdoor Storage Shed \$390
70-1/2in W x 44-1/4in D x 52in H



Outdoor Storage Shed \$705
100-1/2inW x 52-3/4inD x 8ft 7 in H

- **Fire Hose:** They originally provided a hose that could attach to a fire hydrant as part of the cache contents, but have since moved away from that. They now provide a wildland hose that attaches directly to a residential spigot, allowing for easier use.

CACHE CONTENTS:

Box 1: PPE	Box 2: Fire Suppression	Box 3: Electrical	Box 4: Misc.	Loose Items
6 Hard Hats 3 Small Gloves 3 Lg Gloves 3 XL Gloves 40 N95 Respirators 6 Safety Glasses	2 Fire Extinguishers 2 Backpack Pumps 4 100 ft 3/4 in Fire Hose 2 Double Male Fittings 2 Double Female Fittings 4 Nozzles	4 Extension Cords 2 Power Strips 2 Ground Lights 4 Flashlights 8 DD Batteries for Flashlights 6 Radios 1 Emergency Radio	2 Water Barrel Pumps 2 Water Barrel Wrenches 2 Water Treatment 2 Collapsible Buckets 4 Caution Tape 4 Duct Tape 2 Hammers 1 Combination Lock	2 50-gal Water Tanks 1 Large Medical Kit 1 Propane Generator 2 10-gal Propane Tanks 1 10ft x 10ft Canopy 1 7ft Tripod Light 2 Axes 2 Pry Bars

CASE STUDY B2: COASTAL CACHE

A NEIGHBORHOOD CACHE ON THE OREGON COAST

The Coastal Cache was established and funded in 2015 through a partnership with the fire district, homeowner’s association (HOA), and neighborhood residents’ contributions.

This cache is situated at the community’s designated tsunami assembly area and is designed for a response to a Cascadia subduction zone earthquake and tsunami, or other disaster.

The project involved deliberate and targeted community education and outreach, and is designed to be a supplement to the residents’ own emergency supplies and what can be salvaged from surviving homes. Their successful community outreach campaign funded almost all of the cache contents through financial contributions from its residents.



Project Coordination & Authority	The project is managed by a committed team of residents from the HOA, called the Cache Committee Volunteers. The HOA board is supportive of and provides the authorization for their activities.
Purpose	The cache was created to prepare for the response to a Cascadia subduction zone earthquake or other disaster. The cache focus is on very basic survival supplies such as water, shelter, medical, sanitation, and tools to supplement what can be salvaged from surviving homes. Limitation: The team decided not to store food.
Target Population	The cache is primarily for the community members of the HOA. However, others who show up will also be served.
Model	Standalone Disaster Cache
Ownership & Maintenance	The HOA neighborhood has a Memorandum of Agreement with the Fire Department. The Fire Department owns the steel shipping container and the contents in the back fenced-off section of the container. The HOA owns the contents of the rest of the container. The Fire Department maintains the container and rotates water in the barrels. The HOA maintains the rest of the contents.
Funding	The Fire Department applied for a matching grant from the County Commissioners to purchase the shipping container and set it up. The HOA contributed \$1,000 to purchase the water barrels. The remaining contents were funded through neighborhood donations. The team sent out a letter to the homeowners explaining the project and asking for contributions. The project was fully funded within one year. This is in part due to multiple preparedness activities that the community had offered their residents prior to starting the cache project. Large-scale community buy-in was a result.
Location	The cache is located at the neighborhood Temporary Tsunami Assembly Area. It is positioned on a small portion of HOA property that is a public easement.
Storage Building & Security	The cache supplies are stored in a used, 20-foot steel shipping container. The ground was prepared with a layer of gravel and 4 x 4 wood boards for the base. It is secured with a combination lock with a Ranger Lock-guard over it. A security camera is positioned nearby. The Fire Department and Coastal Cache team members have the combination.
Contents	See the content list on the next page.
Deployment	The HOA can self-deploy the cache in a disaster as needed and has developed an instruction manual for operations, kept inside the cache (see Appendix G).

B2: COASTAL CACHE

Keys to Success/Innovative Strategies:

- **Champion & Team:** The Cache Planning Team was a very committed group of volunteers who were knowledgeable about disasters and Cascadia, passionate about getting prepared, and dedicated to investing the time in educating their neighbors and seeing the project through.
- **Fish Nets & Wall Colors:** The Cache Planning Team realized that a Cascadia earthquake meant the possibility of 4-6 minutes of intense shaking, resulting in the likelihood of things shifting around in the cache container. They decided to secure many of the contents by hanging them in fish nets from the hooks near the ceiling. They also painted each wall a different color to help identify where things should be located after the shaking stops. They proceeded to draw a map to show what is hanging in each net and on each color wall, and where in the cache items are located.
- **Fire Department Storage:** The fire department designated the back portion of the shipping container for their own disaster supply storage. They installed a fence to delineate this section and applied a lock that is only accessible by the fire department.
- **Commode System & Latrine Trench Design:** The team realized that surviving community members will be isolated for weeks and possibly months after a Cascadia earthquake due to their remote, rural location. To manage restroom needs, they designed a practical commode & latrine system for their aging community to help manage sanitation and human waste. See Appendix E for drawings, photos, and instructions.
- **Stretchers:** Realizing that search and rescue along with medical operations will likely be the responsibility of the surviving neighbors, the team constructed wooden stretchers. They placed them on top of the water barrels to help other storage items have a stable base for stacking things.

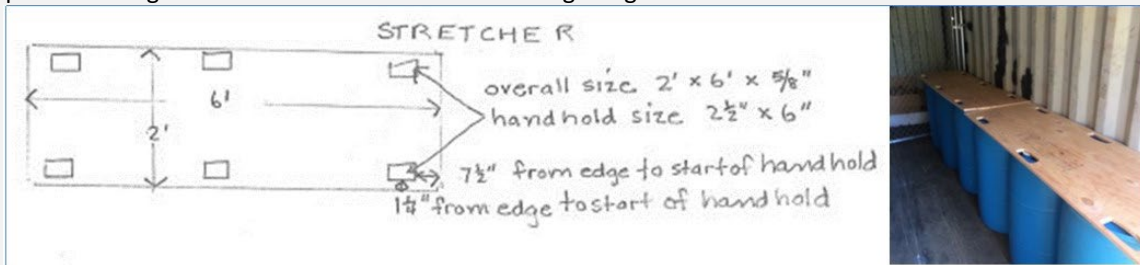
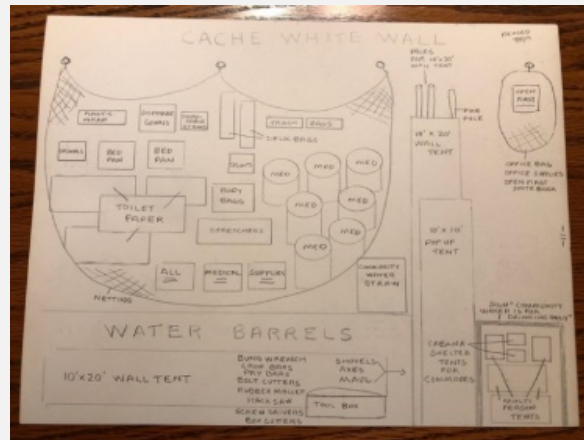

CACHE CONTENTS:

Shelter & Warmth	Water	Medical Supplies	Sanitation	Tools	Misc.
Tents, various sizes Tarps, rope Stakes, mallet Waterproof seal Mylar blankets	Water barrels & bung wrench Community LifeStraw Water Filters Siphon pump Measuring cup Funnel Solo cups Jugs	Stretchers Body bags Gloves Gauze bandages & rolls Medical tape Sheets Sheet bandages First Aid book Betadine Rubbing alcohol SAM Splints	Privacy tents Commode system Commode Toilet Paper Gallon Ziplock bags Scoops Electronics Lanterns Flashlights NOAA Radios	Sledge hammer Pike pole Crow bars Pry bars Hatchet Hammer Bolt cutters Pipe cutters Shovels Screwdrivers Grabber Box cutter	Office supplies Fire extinguisher Flare gun & flares Orange fluorescent paint Caution tape Orange fencing Plastic garbage bags Plastic sheeting Lighters Waterproof matches
Personal Protection					
Rain suits Dust masks Leather gloves					

CASE STUDY B3: COOS BAY

COOS BAY DISASTER CACHE PROGRAM	
<p>The City of Coos Bay has disaster caches located strategically throughout their community: at schools, a church, a community college, and a boys and girls club for easy access after an earthquake and tsunami.</p> <p>The caches have been designed with the premise that surviving community members are able to take shelter inside of the existing buildings (schools, churches, etc.) and use the disaster cache contents to support their basic survival needs inside each shelter.</p> <p>The City has prioritized this both with financial resources and staff resources to plan, implement, and grow this project. It is one part of the City’s overall disaster preparedness efforts.</p>	
Project Coordination & Authority	The City’s emergency manager coordinates and manages the cache development efforts, with the assistance of other city staff and multiple partners.
Purpose	To meet the community’s basic needs in response to an earthquake and tsunami. Primary focus is food, water filtration system, cots & blankets, medical supplies, tools, safety gear, radios and cribbing lumber for search and rescue. No water storage.
Target Population	Coos Bay has 3 major neighborhoods expected to be ‘islands’ after an earthquake and tsunami. The caches are spread throughout the three neighborhoods, and are out of the tsunami zone. The target population includes everyone: schools, community members, tourists, first responders, long-term care facility, etc.
Model	Standalone Disaster Cache
Ownership & Maintenance	The school district owns the containers at the schools. The City owns the contents. They have a written agreement modeled after the Red Cross Agreement.
Funding	The school district purchased the 40’ shipping containers. The City Council provided funding for the contents of the caches. The contents of one container cost about \$50,000. The city has allotted various amounts of money towards the project over the years, starting with \$10,000 the first year and increasing to \$45,000 in 2019. This is an ongoing project.
Location	Three caches are at K-12 schools, one is at a Boys & Girls Club, one at a church, and one at community college. These are assembly areas that match up with shelters, but there are no signs on the containers identifying them as emergency supplies.
Storage Building & Security	The disaster supplies are stored in 40-foot steel shipping containers with spray insulation and extra vents added to help prevent condensation. The containers are secured with a robust locking system made by <i>Abus</i> with a high security re-keyable padlock. The City has access.
Contents	Each cache serves 400 people for 2-weeks. They do not store water but they have heavy duty water filtration systems in the cache. See content list on the next page.
Deployment	Caches can be deployed in a major disaster when emergency services are not readily available due to the disaster.

B3: COOS BAY DISASTER CACHE PROGRAM

Keys to Success & Innovative Strategies:

- **Funding:** With strong support from the City Council who budgets for the cache supplies, and help from partners who purchased some of the shipping containers, funding has certainly been a key to their success.
- **Champion & Partnerships:** This project has benefited from having a dedicated person to lead the effort. People have been very willing to step up and help, including to build shelves, paint, make vents, and more. The team secured suitable locations for the caches through strong community partnerships with schools, a church, a Boys & Girls club, and a community college.
- **Disaster Preparedness:** The cache project is only a small piece of the City’s disaster preparedness efforts. They have been equipping staff in all departments (fire, police, emergency management, city staff, and CERT) with training and resources. They train the public with tsunami drills, the Great Shakeout, the Blue-Line Project, 2-weeks ready, Red Cross drills, and do presentations in creative ways.
- **Low maintenance.** The caches are low maintenance. The food they selected for long-term cache storage has a 30-year shelf-life. They decided not to store water, which eliminates the need for water rotation. They insulated and vented the containers to prevent moisture.
- **Stacking & Organization:** Their team built the shelving inside the cache containers; the lumber was donated. They secured the shelving with 2x4 boards at the top to prevent tipping during ground-shaking. There is a narrow aisle down the middle for access to the back.
- **Insulation & Ventilation:** The team added vents and spray-foam insulation to the shipping container to reduce condensation. The firefighters cut holes in containers to create 12x20” vents, aluminum louvered with a screen (left photo). The vents are riveted in and sealed with caulking. A fabricated spacer fills the gap created by the corrugated side of the container. The right photo shows the sprayed insulation to reduce condensation and a welded piece of rebar through the middle of the vent to prevent potential break-ins.



Challenges & Lessons Learned:

- **Security Concerns:** One shipping container was broken into twice; the keybox (a Knox Box) was cut through and the container subsequently damaged. The containers now have a more robust locking system (Abus model 215/100) that cost about \$400 per complete lock system.
- **Purchasing:** Purchasing to find the right cache supplies was the biggest challenge. For example, the original cots were too bulky to store, taking up valuable space in the cache. After trial and error, the team found cots of a manageable size at Costco. Moving forward, the planning team would like to secure a long-term purchasing agreement with a distributor for consistency and fixed pricing of cache supplies into the future.

CACHE CONTENTS:

Shelter & Warmth	Food	Cooking Supplies	Serving Supplies	Misc
408 Blankets 400 Cots, regular 20 Cots, XL 6 Boxes children coats	Mountain House Meals #10 cans, 10 servings ea 282 Chili Mac w/Beef 282 Chicken & Rice 282 Teriyaki Chicken 282 Beef Stroganoff	2 Propane burners 4 five-gal Propane bottles 2, 40-Qt. Pot w/lid	11,205 Bowls (Dixie 20oz) 12,000 Plastic spoons 6 Full-size serving pan w/lid 6 Serving spoons 4 Aprons 2 Hot pads 1 Can opener (commercial)	Disaster First Aid Kit 2 Water filter systems (Sawyer Point ZeroTwo) 4, 5-gallon Water Jugs 10 Water buckets 10 Boxes playing cards 2 Boxes stuffed animals & toys

CASE STUDY B4: EAGLES NEST

EAGLES NEST HOME OWNERS ASSOCIATION (HOA) DISASTER CACHE

The Eagles Nest HOA has established a standalone disaster cache for their neighborhood because it expects to be geographically cut off from outside help after a large Cascadia subduction zone earthquake.

In 2014, the HOA approached the local fire department about a disaster preparedness matching-grant opportunity. The Fire District was the eligible agency for the grant and agreed to partner with the HOA and apply for the grant. The grant and HOA funds totaled \$5,000 and provided for the purchase of a new steel shipping container, site preparation, and a few initial supplies. The HOA budgets a small amount of funds each year to continue stocking the cache. It is a 10-year plan.



Project Coordination & Authority	The initial and ongoing development and management of the cache is the responsibility of the HOA’s Safety Committee. The HOA Board approves each year’s proposed cache expenditures recommended by the committee.
Purpose	Purpose: Supplemental supplies to support the initial safety and survival needs of the HOA residents immediately following an earthquake or other disaster. Focus: The cache exists to assist with survival supplies for 48-72 hours including but not limited to shelter, water, sanitation, first aid, and light search & rescue. Limitations: The cache is designed to be supplemental. Residents must: 1) prepare their own disaster supplies, 2) work to take care of themselves and provide support to their immediate neighbors during a disaster, and 3) ban together as a community to meet needs using supplies that can be salvaged from their homes.
Target Population	Residents of Eagles Nest Home Owners Association (HOA). Eighty percent retired residents, many pets (dogs and cats), no children.
Model	Standalone Disaster Cache
Ownership & Maintenance	The HOA owns and maintains the cache. The Fire Department changes the water in the barrels every five years. The Cache is designed to be very low maintenance.
Funding	An initial matching grant opportunity with the fire department and the county was the impetus for the HOA to dedicate funds to get the disaster cache off the ground. The HOA has a small annual budgeted amount to add supplies to the disaster cache each year. Some neighborhood residents have also donated supplies to the cache that are aligned with the mission. The first cache should be complete in ten years. The Safety Committee is exploring options for a second cache location.
Location	The 20-foot shipping container is located on HOA Common Property. 1. North Area: by the basketball courts. 2. South Area: TBD (The HOA plans to establish a second cache in the future).
Storage Building & Security	The cache is stored in a new, 20-foot steel shipping container that has a raised & packed gravel base, and is elevated on railroad ties. It is secured with combination locks that can be changed if necessary. It is accessible by the HOA Board, Manager, Safety Committee, & Neighborhood Area Captains. The Fire Department also has the combination.
Contents	See list of contents on the next page.
Deployment	The cache can be deployed in a major disaster by any HOA board member, safety committee member, or neighborhood area captain. The Fire Department was invited to use the supplies when the COVID-19 pandemic began.

B4: EAGLES NEST HOME OWNERS ASSOCIATION (HOA) DISASTER CACHE

Keys to Success/Challenges:

- **Location:** Finding a place to put a 20-foot steel shipping container can be challenging. This HOA carved out space near their basketball courts. There was some controversy in terms of aesthetics, so the HOA decided to purchase a new (rather than used) shipping container to help with appearance.
- **Low Maintenance:** The decision to get a new (not used) shipping container also helped to keep maintenance low, which was a priority of the Safety Committee. The steel shipping container is wind & water tight which means no rodents. The HOA has not had to paint the container, nor has it applied anything to the roof. It chose not to insulate it and has not had any trouble with moisture. After six years, the only maintenance needed has been to occasionally apply WD40 to the locks.
- **Team:** At the beginning, they had a very small team on the Safety Committee to decide on and make purchases. After a few years, the team grew large and could not reach consensus on how to prioritize the small annual budget. Because of this, nothing was added to the cache during that time. The team is now small again and the cache has continued to be added to and improved. For this HOA, having a small unified team is a key to their success.



CACHE CONTENTS:

Shelter & Warmth	Water	Medical Supplies	Search & Rescue	Tools & Misc.
Tents Pop-up canopies Tarps Rope Mylar blankets Cable ties Moving strap set Moving blankets	55-gallon barrels of water, hand pumps, bung wrench, & purifier solution Water filter straws Bottles of water 5-gallon bucket water filtration systems Plastic drinking cups	First Aid kits Medical gloves Evacu-Aid stretchers Cloth strips & triangle bandages Sheets & linens Morgue kit	Leather work gloves Flashlights Headlamps Search & rescue backpack kits Cribbing wood	Empty gas cans Traffic barricades Barricade flashing lights Barrier tape Head light w/stand Power block Safety cones Extension cords Generator Ladder
Sanitation	Food	Incident Command	Clean-up	
5-gal buckets Toilet seat/lids Toiletries <i>The Humanure Handbook</i>	Survival food bars Dry Pinto Beans, Brown Rice, Oats in 5-gal buckets	Large HOA posters Clipboards Sharpies Two-way radios	Plastic sheeting Contractor bags Flat shovels Brooms	

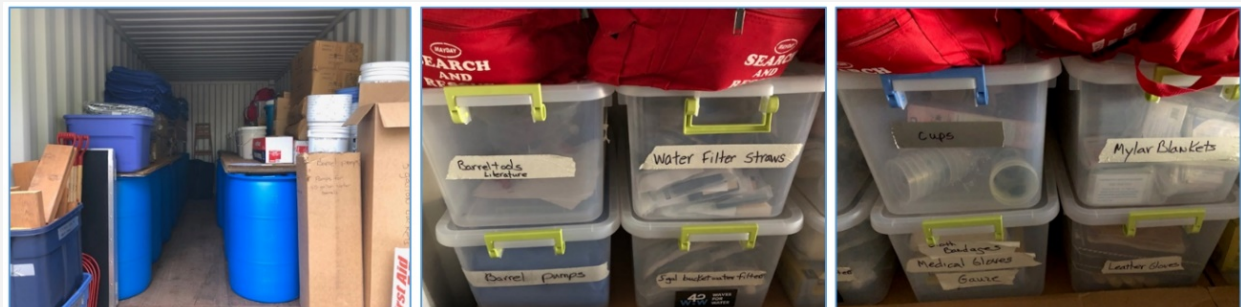

CASE STUDY B5: EASTSIDE CERT

EASTSIDE COMMUNITY EMERGENCY RESPONSE TEAM (CERT) SUPPLY CONTAINER

A team of very committed Eastside CERT volunteers developed a cache of supplies almost completely through community donations. The cache is stored in a 40-foot steel shipping container and housed on school district property. It can be used by their CERT group for any type of disaster. The cache has exceptional organization.

The container is not just about supplies, it is about how to set up and organize their response. Their team attended a Red Cross Shelter training and customized a shelter form for their CERT needs. They even have a “Rules” book for how to deploy the cache supplies and help manage people in a disaster.

There are office supplies, customized shelter forms for tracking, and a mapping project that shows how to set up the area with designated morgue area, sanitation, pet area, camping area, etc. There is also a [laminated document](#) (right) that demonstrates how to set up shelters using tarps.



Project Coordination & Authority	This is completely CERT volunteer driven. They have a 15-person CERT team with a dynamic and committed leader. Everyone on the team has special skills and has been described as a powerful group of really wonderful people. Monthly meetings and communication are keys. There is no agency person leading the effort.
Purpose	Purpose: Response to an earthquake or other disaster. Focus: Search & Rescue, Communications, Medical, Incident Command, and some basic needs supplies for warmth, comfort, and minor care. They do not store or serve food.
Target Population	Neighbors, school children, visitors, first responders, and pets.
Model	Standalone Disaster Cache
Ownership & Maintenance	Eastside CERT owns the container and contents. The school gave permission to Eastside CERT to have the container on school property. CERT inspects and inventories it twice per year.
Funding	The CERT group started by developing a 501c3 to have a mechanism to receive donations, track things, and give people/businesses tax write-off opportunities. Other than two very small grants of about \$500 each, everything has been donated. They do not do fundraisers and have not received any agency funds.
Location	The cache is located on school property and near an unmanned fire station.
Storage Building & Security	The supplies are stored in a 40-foot steel shipping container, insulated and vented. CERT uses a keyed padlock that goes in a ring in the container that makes it very difficult to cut open with a bolt cutter. They are very concerned about security during a disaster. They have a Rule Book with security protocols that shows who from Eastside CERT has keys.
Contents	See list of contents on the next page.
Deployment	Designated CERT members have keys and can deploy the cache in a disaster. They have fencing and a couple tables to put around the entry of the cache for security. Two people must be there to open it. One will be designated security.

B5: EASTSIDE COMMUNITY EMERGENCY RESPONSE TEAM (CERT) SUPPLY CONTAINER

Keys to Success/Lessons Learned:

- **Asking and Thanking:** Their philosophy is “all you have to do is ask” for what you need. ‘Donations’ has been their whole focus, and the community has responded. When a team member went to the dentist and told them about the cache, the dentist gave 120 toothbrushes and floss. They asked for scrap lumber from a construction site and made stretchers with handholds out of plywood. When buying paint for a house project, a team member received free buckets for the cache from the paint store. They obtained surplus folding chairs for \$1 each when the old school was demolished. Even the shipping container was donated...they asked for it. Their leader sends thank you notes, saying, “that’s my main thing in life!”
- **Stability & Organization:** To keep things from falling over in the cache they used 2x4s and plywood from a construction site and made shelves. They used rubber rope (the kind that tie boats down) to make bungee cords to hold everything in place. Everything is meticulously organized in clear plastic totes that are clearly labeled. There is even a section in the back of the container with a desk and chair, and a curtain for a privacy area in case CERT members need to change out of wet clothes.
- **Lighting:** There is no electricity to the shipping container. It is dark inside, even with the doors open. They installed LED string lights on the ceiling, powered by 2 truck batteries with 2 terminals and a battery charger stored. The lights are operational for 3 hours before the battery needs to be recharged. Reminders to turn off lights when leaving is essential.



CACHE CONTENTS:

Construction & Storage Items	Water & Food Prep	Medical Supplies	Search & Rescue	Communications
Container, shelves, insulation, padlocks. Rubber rope for bungies, Vents, LED light strings. Totes, vacuum & sealer bags. Clothes line & pins, chairs, tables, garden boxes & trowel, peat pots, file cabinet, sandwich board, white board, carts.	Water barrels, Sawyer bucket filter systems, strainers, pumps. Bleach, soap, white vinegar. Styrofoam coolers. Fishing kits, dip nets. Dishes, cups, plates, forks, & spoons. Pots & pans, lids, soup bowls. Cooking utensils, BBQ & firewood starters.	Slings, sheets, pillowcases, braces & splints, band aids, gauze pads, tape, stretch wrap rolls, scissors. Antibiotic scrubs, ointments, gloves, cotton swabs, cold & hot packs. Foot covers, cast wrap, bath cloths, stethoscope, walkers, crutches.	Masks, work gloves, shovels, picks, axes, brooms, rakes, hand saws, cribbing wood, fire extinguishers, hammers, nails, screws & drivers, wrenches, tiedowns, electric & duct tape, hose, stretchers, rope, sawhorses, ladder, wheelbarrow, step stool.	Emergency Radios, reflective vests, flares, traffic cones, signal mirrors, colored flag tape, caution fliers, clipboards, paper, markers, pens/pencils, chalk.
Hygiene	Comfort	Pets	Warmth	Fire & Light
Toothbrush/paste, floss, combs, hairbrushes, soap, shampoo, lotion, razors, wipes, deodorant, nail clippers, wash basins. Adult & baby diapers, sanitary pads, toilet paper, buckets.	Puzzles, games, peg games, child activity packs, tops, cars, dolls, yo-yos, frisbee, football, softballs, cards, and bubbles.	Pet dishes, leashes, collars, choke collars, harnesses, muzzles, horse leads, tie-out cables, trolley cables, stretch wrap, towels, blankets, rags, fencing & posts.	Blankets, coats, sweatshirts, child to adult sizes, socks, gloves, hats, scarves, boots.	Fire starters/lint, box of firewood, batteries, flashlights, candles.

CASE STUDY B6: GEARHART

GEARHART EMERGENCY CACHE CONTAINER PROGRAM

The City of Gearhart’s [Emergency Cache Container Program](#) uses a partnership between the City and its residents to empower residents to prepare personal supplies for response to an earthquake and tsunami. The City established an Emergency Cache Storage Container at their primary designated Tsunami Assembly Area. For a small annual fee, residents can rent space in the City’s Emergency Cache Container to place a 30-gallon drum filled with their own disaster supplies.



The program motto is, “Essential Supplies: You bring them. You pack them. We store them.” Details can be found on their [website](#).

Project Coordination & Authority	A small but dedicated city staff established the program and work together to do all the planning and coordination. Some CERT volunteers assist. The City Council is very supportive. There is ongoing work required for the two access days per year, annual billing, and continued development of the program.
Purpose	Purpose: To empower Gearhart residents to be proactive and prepare to meet their own basic needs in response to a Cascadia earthquake and tsunami. Focus: Provide a secure place out of the tsunami zone for residents to store a personal bin full of their preferred emergency supplies to supplement, not replace, their 72 hour Go-Bag beyond the first three days.
Target Population	Gearhart residents.
Model	Storage for Residents’ Supplies
Ownership & Maintenance	The City owns and maintains the Conex boxes where residents store their drums of supplies. The residents purchase, own, and maintain their drum and supplies. The Conex box is opened for residents to add, remove, or rotate their personal cache items twice each year.
Funding	The three-prong funding plan includes: <ol style="list-style-type: none"> 1. The City has a reserve fund (\$15,000) for pre-disaster mitigation, and used those funds to purchase Conex boxes for the Cache program, as well as 30-gallon drums to sell to residents. They also received two State Homeland Security Grants to purchase a limited amount of emergency supplies for general use for those who gather at the assembly area. 2. Gearhart residents can purchase a 30-gallon drum from the city for \$70 or provide their own drum that meets size specifications. Residents must provide all their own supplies for inside their drum. 3. Residents must rent storage space for their drum in the Conex box for \$40 per year, billed annually by the city.
Location	The cache is located at the city’s tsunami evacuation site at the water tower.
Storage Building & Security	Supplies are stored in two 20-ft steel (single-trip) Conex boxes. The City secures the Conex boxes and provides locked gate security with camera surveillance. The supplies inside the Conex boxes are stored in 30-gallon poly-plastic drums with tightly secured quick-lock lids that are zip-sealed and labeled with a serial number for tracking and organizational purposes.
Contents	Residents decide what to store in their drum. Suggested items include tents or tarps, sleeping bags, water storage containers, warm clothing, first-aid kit, sanitation supplies, batteries, cookware. Limitations: No gasoline, kerosene, or single-use plastic water bottles can be stored.
Deployment	In an emergency the cache will be accessible by the city emergency manager, police and fire chief, and possibly a CERT member. Residents indicate on their MOU under what circumstances their personal drum can be deployed.

B6: GEARHART EMERGENCY CACHE CONTAINER PROGRAM

Keys to Success:

- **Standardize Drums:** The team decided to standardize the type and size of the drum people could store their personal supplies in. They chose a drum made out of a poly-plastic material rather than steel or aluminum. The poly-plastic helps to reduce moisture and allows for a very tight seal and locking mechanism. They also selected a consistent 30-gallon size drum (rather than allowing various sizes of storage drums and containers) because the 30-gallon drums are easy to maneuver and are stackable on racks that they installed inside the Conex boxes. The required drum specs are: 29-30" tall x 18-20" around, and weigh 14-16 pounds empty.
- **Shared Funding & Responsibility:** The City's diverse three prong approach to funding has made this project manageable financially. The project embodies a shared preparedness responsibility between the City and its residents. Another key to success is a staff member who is skilled at writing grants.
- **Marketing Brochure:** The City created a visually appealing marketing brochure that clearly explains the opportunity, participation requirements, and answers some frequently asked questions. See below.
- **Written Agreement:** The City has a written Memorandum of Understanding (MOU) that anyone participating in the project must sign. It spells out many important aspects of program, including obligations of each party, payment, termination, disclosure, liability, cache access privileges, and deployment instructions. The MOU can be found in Appendix D.

Lessons Learned:

- **Size of Tents:** The City received feedback that it is difficult to find a tent with poles that fit in the 30-gallon drums. The City is working to find some tents that do fit well in the drum so they can provide some suggestions for residents to consider.

WHAT IS A CACHE CONTAINER PROGRAM?
In the event of an emergency, what if you had the option to access a personal bin full of clothing, food, and other supplies you hand-selected? A cache ("kaSH") container program will make this option a reality for participating community members.

CITY OF GEARHART
688 Pacific Way | PO Box 2510 | Gearhart, OR 97138

CONTACT US
Gearhart Cache Container Program
Gearhart City Hall | 503.738.5501 | www.cityofgearhart.com

GEARHART EMERGENCY CACHE CONTAINER PROGRAM

ESSENTIAL SUPPLIES
You bring them.
You pack them.
We store them.
Take the next step in personal emergency preparedness.

WELCOME
Gearhart has established a permanent evacuation site at the water tower off of Salmunee Road to house city emergency supplies and our community cache container program.
Your cache container is purchased and owned by you. Securely stored within a large conex bin, the contents chosen are unique to you and are designed to assist until an emergency passes.
More than likely, the City of Gearhart will not have the resources to meet all of your needs. Owning your own container is the best option for personal well-being.

SUGGESTED ITEMS
CERT recommends storing essentials relevant to survival during an emergency. Need a list to start?
Tents and/or tarps; sleeping bags; water storage containers; food variety – canned, dried, and freeze-dried – shelf-life can extend up to 20 years with freeze-dried food and 5-6 years with canned, warm clothing; first aid kit; sanitation supplies; light source and batteries; camp cookware.
Consider twice yearly access and expiration dates when selecting your items!
Please contact us for recommendations specific to you and/or your family. We are happy to help!

INVESTMENT
Cache Program Annual Storage Costs
Shop for your container based on the required specs below – fill it – we store it for the listed cost, billed annually.
30 gallon – \$40 per year – polyethylene only, with lid [29-30" H x 18-20" D, 14-16 lbs w/filled]
Contact us for information on where to buy your 30 gallon drum locally!
WHEN IS MY PERSONAL CACHE CONTAINER ACCESSIBLE?
The evacuation site will open for owners to add/remove and rotate their personal cache items twice each year – April and October.

WHAT ITEMS ARE EXCLUDED FROM THE CACHE PROGRAM?
NO gasoline or kerosene
NO (contaminable) plastic water bottles

JOIN TODAY!
503.738.5501

EXAMPLE
30 gallon poly-plastic drum with lid

CASE STUDY B7: JOYCE

JOYCE EMERGENCY PLANNING & PREP (JEPP)

Jim Buck and his friends formed a 501c3 organization in 2015 called [Joyce Emergency Planning and Prep \(JEPP\)](#). JEPP’s goal is to be prepared to shelter and provide for the basic needs of people displaced by an earthquake and tsunami. Approximately 20 members of the JEPP team received Red Cross shelter training and will provide the core shelter staff at the Joyce Bible Church, where they hope to set up shelter operations after an earthquake. They have acquired caches full of supplies to meet the needs of survivors for 30-days. They also have a garage to house their MKT 99 Army field kitchen, portable water treatment plant, and 10 KW generators. Their efforts include extensive research, public education, and team training on disaster preparedness and response. Two of their community trainings are called, "Camping in Your House" and "30 Days on Your Own." They also developed a *Guide for Joyce Shelter Operations and a Mortuary Plan* (see Appendix G).



Project Coordination & Authority	JEPP is part of the Joyce Fire Department Auxiliary and has a direct relationship with the Clallam County Fire District #4. These two organizations, along with the American Red Cross, have a written Memorandum of Understanding addressing all aspects of the cache (see Appendix D). JEPP has a small team of very committed and motivated volunteers, retired educators, engineers, law enforcement, homecare nurses, and other community members. Their team has donated a lot of their own time, money, labor, and resources to make this project a reality and to maintain it. It is completely volunteer driven. Key: <i>“Not much talk and a lot of action.”</i>
Purpose	Purpose: Response to a Cascadia subduction zone earthquake and tsunami that isolates the community of Joyce. Focus: Supplies, equipment, and instructions to operate a basic needs shelter without traditional resources such as power, water, sewer, or access to emergency services.
Target Population	The Cache will serve up to 300 people who are displaced after the earthquake and need shelter and basic needs met. It is not for the people who can return to their own homes after the earthquake.
Model	Standalone Disaster Cache
Ownership & Maintenance	The Fire District owns, insures, and maintains the security of the caches. JEPP owns and maintains the contents of the caches. A limited number of keys have been distributed to the planning team and one is in the key box at the fire station.
Funding	The JEPP 501c3 non-profit organization manages all finances, records, and reporting for the emergency cache project. They have not received any “agency” budgeted funds for their project. Over the last five years, they have raised about \$60,000 in donations, grants, community contributions, and bake sales.
Location	One shipping container is located on fire district property, and the other is at Joyce Bible Church. The garage is also at the church.
Storage Building & Security	JEPP has two 40’ steel shipping containers for disaster cache supplies. They also own a 20 x 20’ steel garage (with a concrete floor) that holds the field kitchen, water treatment plants, generators, and fuel (see Appendix E).
Contents	The JEPP caches include shelter supplies such as cots and blankets, food, water purification supplies and equipment, medical, and sanitation supplies. The Red Cross also stores supplies in the shipping containers. Two separate inventories are maintained.
Deployment	The team only plans to deploy the cache in a major disaster if the bridges go down and access to outside help is not possible.

B7: JOYCE EMERGENCY PLANNING & PREP (JEPP)

Lessons Learned & Innovative Strategies:

• **Insulation:** To keep the temperature inside the container at acceptable levels, which helps maintain the life of the items in the cache, the JEPP team painted the exterior of the container with white SOLAR FLEX reflective paint and insulated the inside of their 40' shipping containers. They insulated the first container with a 1" layer of spray foam insulation, which "was very messy and expensive," costing about \$3,500. For the second container, they installed 2" foam board (with Liquid Nails) costing about \$900 total. The foam board is then held in place by a free-standing internal wooden frame. The free-standing frame allows them to install shelving and lighting without making holes in the container.



• **Shelving:** For their first container, they used lumber and built shelves. For the second container they also bought heavy-duty gorilla racks from Costco and anchored them. The gorilla racks were stronger, much less expensive, and simple to install. They figured out how big their tubs of supplies were and adjusted the space between shelves to maximize storage.

• **Pole Building Shade Shelter:** The JEPP team decided to install a shade shelter for their containers to reflect direct sunlight and help reduce the temperature in the container. The shade shelter also extends the life of the container by keeping it out of the rain. They built a freestanding Pole Building with fencing and a shade roof for their first shipping container. The chain link fence provided an extra measure of security for the container. Jim Buck explained that in retrospect, the entire roof project was prohibitively expensive. Not only were the materials and labor to build it costly, but it also required professional plans and they had to pay \$600 to the county for a building permit and plan review.



Shade Roof Solution: They found they could save money and time by eliminating the pole building and installing a shade roof directly onto the container (right drawing). It still required some materials and labor, but not nearly as much. It saved them over \$3,000. They found the plans on this website: <https://www.discovercontainers.com/how-to-fit-a-roof-onto-your-shipping-container>.

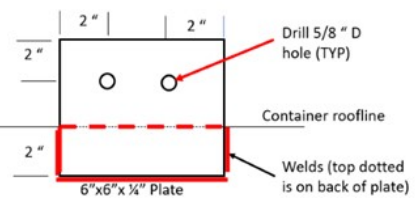
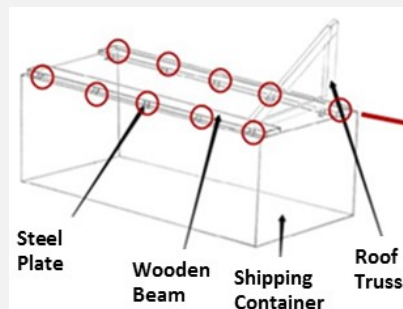
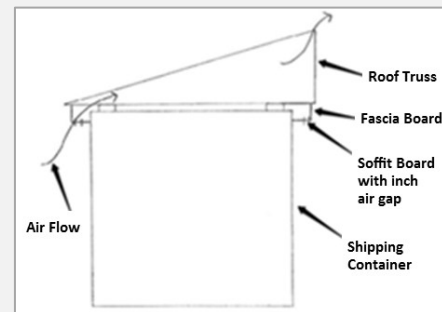

Weld 10 each 6"x6" x 1/4" thick steel plates at locations shown on sketch.

COSTS FOR CONTAINER, ROOF, INSULATION, AND SHELVING: \$9,096

Container & Shade Roof	Insulation	Shelves & Lighting
40' High cube container: \$3,000 Metal Roofing 40' x 10': \$2,000 Welding, wood rafters, purlins: \$800 Concrete Anchors: \$800	2" Foam Board 4'x8' Insulation (38 sheets x \$22 each) = \$836 Liquid Nails bulk 3.5 gallon = \$60	Framing Lumber: \$350 Gorilla Racks: \$850 Electrical hookup, lights: \$400
TOTAL Container & Roof: \$6,600	TOTAL Insulation: \$896	TOTAL Shelving & Lighting: \$1,600

CASE STUDY B8: LINCOLN COUNTY SCHOOLS

LINCOLN COUNTY SCHOOL DISTRICT DISASTER CACHES

If a large Cascadia subduction zone earthquake and tsunami occurs during school, [Lincoln County School District](#) expects that it will be difficult for many families to reunite with their children right away. Due to earthquake damage and continual aftershocks, schools anticipate they will need to take care of children outside of their school buildings for several days, and possibly weeks.

In preparation for this, the school district is developing disaster caches of basic survival supplies that are located outside of their schools but near or within walking distance of each of its schools. The district also hopes to be able to salvage things from each school building to help meet survival needs. The disaster cache project is an ongoing work in progress.

The school district has a small amount of budgeted funds to work with each year that is often coupled with grants and community partner funding. Each year, with those limited funds, either a new cache is started, or supplies are added to existing caches. Each cache is a little bit different, depending on the amount of funding to work with and the availability and costs of supplies at the time each particular cache was developed. Work is underway to standardize contents.



Project Coordination & Authority	The school district’s Safety Coordinator is the lead person who manages the cache. As needs arise, the partner organizations ban together to address those needs.			
Purpose	Purpose: To meet the immediate, basic, survival needs of students & staff after a large Cascadia earthquake and tsunami. Focus: Congregate basic shelter, water, sanitation, first aid, and some clean-up supplies. Two limitations: minimal funding and large population to serve.			
Target Population	If a disaster occurs when school is in session, the cache will be used to meet the basic needs of the school students and staff. If school is not in session, the supplies will be used by the local jurisdiction (city, fire, law enforcement) to assist with the basic needs of the community.			
Model	Standalone Disaster Cache			
Ownership & Maintenance	The caches are jointly owned and maintained by the school district, city, and fire department jurisdiction where the cache is located. There is a MOU spelling out roles and responsibilities.			
Funding	Funding was provided by multiple sources including county grants; city, fire districts, and school district budgeting; businesses, agencies, and organizations contributions; donations, and grants. These caches are being developed over a long period of time.			
Location	Caches are located at or near schools. One on county property, one at a city park parking lot.			
Storage Building & Security	Cache supplies are housed in new 20’ steel shipping containers. The caches are secured by heavy-duty padlocks. Keys are kept in the school Knox Boxes for easy access by their fire department.			
Contents	<p><u>SHELTER & WARMTH</u></p> <p>Large tents, rope, stakes, sandbags, zip ties, tarps Rain ponchos Mylar blankets</p>	<p><u>WATER</u></p> <p>55-gal water barrels LifeStraw Community Water Filter Water filter straws Disposable cups Water jugs</p>	<p><u>SANITATION</u></p> <p>Pop-up privacy tents 5-gal buckets with toilet seat/lid Hand wipes</p>	<p><u>MISC</u></p> <p>100-person Trauma Medical kit Gloves, masks, bandages, Visqueen, shovels, construction bags, Lanterns Search & rescue kit</p>
Deployment	The caches can be deployed during a disaster such as a large earthquake. Schools have the priority, then city/fire.			

B8: LINCOLN COUNTY SCHOOL DISTRICT DISASTER CACHES

Keys to Success & Lessons Learned:

- **Champion:** The school district's Safety Coordinator champions the cache development activities each year. Disaster cache planning and development is time-consuming. Having a dedicated person to lead the effort each year has ensured that continual progress is made. There have also been many dedicated partners that have helped with the cache planning, development and maintenance over the years.
- **Funding:** For several years in a row, the Lincoln County Commissioners have offered an Emergency Preparedness Matching Grant for up to \$2,500 to local cities, fire districts, the Tribe, and school districts. This grant program has been a strategic motivating factor that has empowered the school district and their city and fire partners to pool their monies together along with the grant funds to establish and/or add to the caches.
- **Used vs. New Containers:** When establishing their first disaster cache, the team decided to purchase used shipping containers because they were much less expensive than new containers. But the used containers had problems related to rust, multiple patched holes, appearance, and the gears to open and close the container securely were cockeyed and not easy to use. Since then, the planning team always buy new containers, noting it is worth the extra money. The doors are easy to manage, the seal on the containers is tight, and they are visually acceptable.
- **20 Footers:** The team only buys 20- or 10-foot shipping containers. The 40-ft containers are more economical, but the equipment needed to move a 40-footer is not available in Lincoln County, and they found that the containers eventually need to be moved for one reason or another.
- **Ground Prep:** Take the time to level the ground, lay gravel, tamp it down, and set the container on pressure-treated 8 x 8 wood boards. The 4 x 4 wood boards are not sturdy enough on some surfaces and tend to sink into the ground due to the weight of the cache contents and over time. If on pavement, set the container on 4x8x16" solid block pavers to facilitate airflow.
- **Condensation & Cardboard:** Condensation (also called 'container rain') often forms on the ceiling of the shipping container. The team learned to remove as many things from cardboard packaging as practical and place them in sturdy plastic totes with moisture absorber packets. This helps prevent mildew from forming.
- **Rodents:** They used to have a small wooden building outside a school where cache supplies were stored. Rodents found their way inside. Now they only use steel shipping containers and have never had a problem with rodents getting inside. The steel shipping containers are wind and water tight.
- **Tents are Heavy:** The large capacity garage-type tent canopies are an inexpensive and basic solution for temporary sheltering of large groups of children. However, the packages they come in are extremely heavy and difficult to manage, even for strong fire fighters. Carefully plan where to place them in the container, as they are difficult to move once in place. Once taken out of its box to practice setting it up, it is almost impossible to get it all back inside the box afterwards.
- **Moving Water Barrels:** The 55-gallon barrels are filled with a water purifier solution that makes the water safe for 5 years. After that time, the barrels have to be emptied, refilled with water, and a new purifier solution added. The team learned that purchasing a 55-gallon barrel dolly is a great investment to assist with moving the barrels when it is time to empty and refill them. The dolly is shared with other local cache teams.

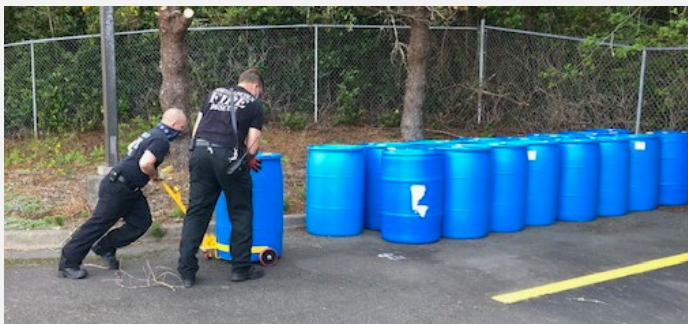

CASE STUDY B9: SAFE HAVEN HILL

SAFE HAVEN HILL & SOUTH BEACH COMMUNITY CACHE

The [Safe Haven Hill](#), South Beach Community Disaster Cache in [Newport, Oregon](#) is located at a Temporary Tsunami Assembly Area in a City park. It is designed to meet two days of basic survival needs for the residents, workers, tourists, and anyone else who evacuates and assembles at the site after an earthquake and tsunami. They plan to relocate this group of people to a more long-term shelter site after tsunami waters subside.

This cache project is designed to serve a very specific yet diverse group of people: anyone in this geographic area at the time of an earthquake who will need to escape a fast-approaching tsunami with very few high-ground options for escape and survival.



Project Coordination & Authority	There is a planning team with representation from the City, Fire, and several area agencies and businesses such as the OSU Hatfield Marine Science Center, Oregon Coast Aquarium, Oregon Coast Community College, Oregon Museum of Science and Industry (OMSI), National Oceanic and Atmospheric Administration (NOAA), Rogue Brewery, and the Wilder Subdivision. The team meets every 2 months and coordinates all aspects of the cache.
Purpose	Purpose: A temporary assembly site in response to a Cascadia subduction zone earthquake and tsunami that follows. Focus: Resources and support items to meet basic needs for the first two days for up to 3500 people. No natural source of water onsite so stored water is a priority.
Target Population	For all people and their pets who evacuate from the tsunami and take refuge at the Safe Haven Hill Temporary Tsunami Assembly Area. This includes tourists (campers, day visitors, hotel occupants, boaters), neighbors, and workers.
Model	Standalone Disaster Cache
Ownership & Maintenance	The cache is loosely jointly owned between participating agencies, with no written agreement. This is purposeful due to the many agencies involved. The OMSI staff visit the cache site often and informally inspect things. If things are amiss, they notify the Fire Chief who contacts City Public Works who does all the site maintenance.
Funding	Initial funding came from federal, state, and local grants, including donations from agencies, businesses, and non-profits. The group does not have a mechanism to receive money contributions. If people want to give money, they are asked to buy and donate items that are on the established needed inventory list.
Location	The cache is located on city park land at the Temporary Tsunami Assembly Area site.
Storage Building & Security	Two 40-foot steel shipping containers hold the cache supplies. There is no fencing around it. A realtor box with keypad/combination contains a key for the padlock. A common city key works on it. The code is given to anyone who comes to our regular meetings. Each organization can distribute the code to those in their organization who need to know.
Contents	In addition to water being a priority item, other major supply categories include medical, shelter, sanitation, safety, pet supplies, relocation, lighting, communications, food, personal warmth, tools, and evacuee management.
Deployment	Anyone with a code to access the cache can deploy the cache when they arrive at the cache after an earthquake. A clearly spelled out Incident Command System and Operations Plan is in place for cache deployment and operations (see Appendix G).

B9: SAFE HAVEN HILL & SOUTH BEACH COMMUNITY CACHE

Keys to Success & Innovative Strategies:

- **Dedicated Team:** A major key to success was a very dedicated team who have made this cache a reality. Along with the overall larger team, there are about three or four core people, and two being the most active and biggest supporters of the project. It would not have happened without them.
- **OPEN FIRST Box:** This team has done significant work to create easy-to-follow instructions for whomever needs to deploy the cache in a disaster. They have a giant gray case right inside the cache door that says *OPEN FIRST*. This box contains their Incident Command binder, communication equipment, and detailed step-by-step instructions for each role in setting up this temporary assembly site. These very informative “Task Cards” can be found in Appendix G.
- **Electricity and Solar:** There is a lamp post/light at this park site, hooked to the city’s power grid. This allowed them to install an electrical outlet on the cache bringing power inside the cache, which run working lights to aid in cache maintenance projects. There is also a solar panel on the roof of one of the containers. The solar panel keeps a battery pack in the cache charged. In a disaster situation they plan to use the battery pack to run medical lights and charge various battery powered communication and lighting devices.
- **Cache Layout:** The team measured their supplies and drew a cache layout diagram to determine how everything would fit, where to store things, and how to easily identify items. They developed a color-coded system to identify major categories of supplies and equipment. Boxes of supplies not only have the item name printed on them, but the corresponding color tape is also applied to the box.



- Medical = Red
- Warmth = Pink
- Water = Dark Blue
- Lighting = Yellow
- Shelter = Green
- Food = Orange
- Sanitation = Black
- Evacuee Management = Light Blue
- Tools = Brown
- Pets = Purple

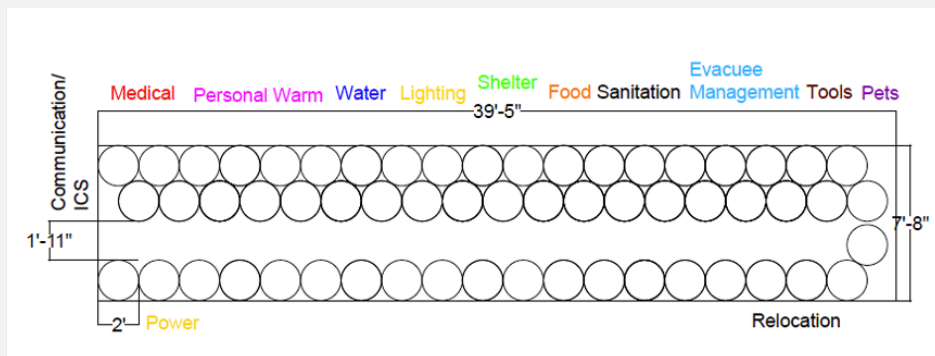

Lessons Learned:

- **Airflow:** Most everything is raised up on pallets to help with air flow. Most supplies are stored in Rubbermaid Roughneck Totes. The first container was fine, but starting having some condensation problems after the second container was brought in. It was placed too close to the first container and blocked the vents. The Public Works Director solved the problem by installing a dehumidifier that is checked monthly.



CASE STUDY B10: SEASIDE

SEASIDE TSUNAMI BARRELS

Since 2007, the City of Seaside has placed 118 emergency supply caches in high-ground areas throughout Seaside. The 55-gallon barrels are filled with survival supplies that will serve 20 people for 3-days. These supply caches are stored in individual homes in the city’s five tsunami evacuation areas. In the event of an earthquake and major tsunami inundation, the barrels are to be rolled out to the street for public access.

Each volunteer that offers to keep an [Emergency Supply Barrel](#) must sign a Letter of Understanding with the City of Seaside that identifies each party’s responsibility concerning the storage and long-term maintenance of each barrel.

The City budgets for replenishing the barrels and replacing expired items every five years. In addition to the barrels the City has placed a portable water filtration system in each of the five designated zones. The purification system is capable of producing safe drinking water at one-gallon per minute.



Project Coordination & Authority	The barrel program is supported by the City. The City staff leads and coordinates the effort. The City is committed to the program and budgets for the program’s sustainability.
Purpose	Purpose: Response to Cascadia subduction zone earthquake and tsunami, or other disaster. Focus: Initial survival supplies for three-days to meet basic needs of 20 people per barrel.
Target Population	Anyone, visitors or residents, who evacuate from the tsunami zone after a Cascadia event.
Model	Dispersed Supplies: Stored in Residents’ Homes
Ownership & Maintenance	The City owns and maintains the barrels and contents. There is a written agreement between the city and the homeowner which describes each’s responsibility in maintaining the barrel and contents (see Appendix D).
Funding	The empty barrels were donated by local candy stores. The city received funding to begin the project in 2007. Now they budget funds to restock the expired items in the barrels every five years at a current cost of \$162 per barrel. Batteries, water tablets, food, a radio, and medical goods are some of the items replenished.
Location, Storage Building & Security	<ul style="list-style-type: none"> • Barrels: The supplies are stored in 118 barrels. The 55-gallon barrels weigh approximately 80-90 pounds, filled. Community members who live in one of the 5 evacuation zone areas store the barrels in their garage or outbuildings. Keeping supplies for survivors gives them an important role and sense of pride in helping evacuees. • A portable Trekker Water Purification Unit (made by Noah Water Systems) is kept with assigned homeowners. A quick-start guide and map showing accessible nearby water sources are attached to the top of the kit. • Locations of Barrels and Water Systems are kept confidential at the homeowner’s request.
Contents	Contents of Barrels: Water purification supplies, food supplies, medical, tools, radios, tarps for shelter, sanitation supplies, and kits with personal necessities.
Deployment	The City’s written agreement gives homeowners instructions on when and where to place the barrels to have it accessible to disaster victims.

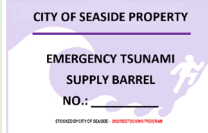

B10: SEASIDE TSUNAMI BARRELS

Keys to Success & Lessons Learned:

- Identify Who is Responsible for What:** It is important to identify the City’s responsibility as well as the volunteer residents. Spending one-on-one time with the homeowner during the restocking reinforces the owner’s commitment to being a participant in resiliency. It is a good time to remind the owner of their important role and encourage them to create their own long-term cache of supplies for any emergency.
- Privacy:** Keep the cache locations confidential, otherwise, people are reluctant to sign up thinking that if people know where the supplies are, their homes might be looted in an emergency. They felt reassured knowing many of their neighbors were participating in the plan and their community’s confidentiality was maintained. Only department heads and key city employees have access to the list and contact information, including email, for restocking purposes.

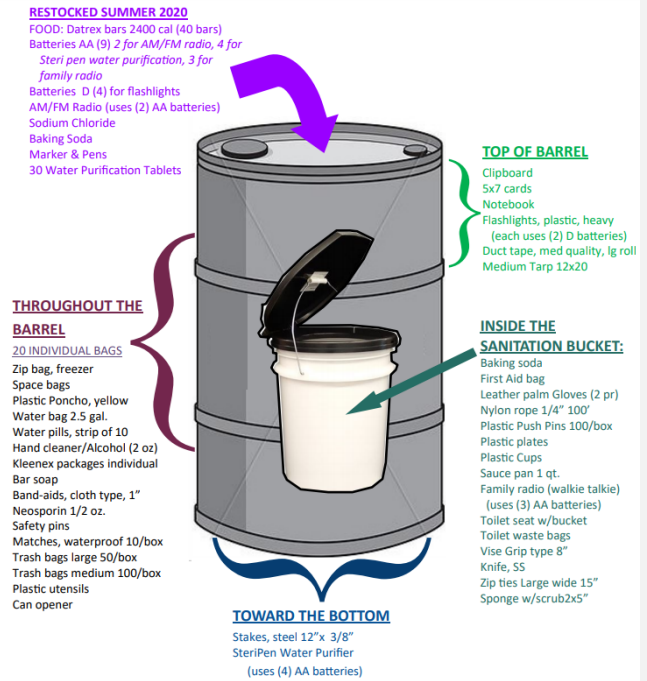

- Contents & Packing:** Take time to think through the contents as well as how you pack the barrel. What are the conditions likely to be and what do people need immediately (rain poncho, flashlight, blanket) based on the potential conditions (rain, dark, blowing, cold)? Seaside took the time and did the work to put together a strategically packed barrel.
- Time Management:** This is a time-consuming project, even for replenishing the expired items. To start, the program took a lot of hands – volunteers, interns, and community, which equals media support and outreach to committees and groups. A student intern and volunteer helped with the restocking and heavy lifting. This enabled Seaside’s Emergency Coordinator to personally visit with and connect with the volunteers and thank them for their support. The timeline was substantial; it has taken a year to complete the restocking.

CITY OF SEASIDE TSUNAMI BARREL SUPPLY LIST

ITEM	Gross Ct.	ITEM	Gross Ct.	ITEM	Gross Ct.
Space Bags	20	Datrex bars 2400 cal	20	Cotton Swab	100
Plastic Poncho	20	SOS Bar 3600 cal.	20	Nitrile Gloves, Large	10
Toilet paper tissue packets	100	Water bag 2.0 gal.	20	Cups 16 oz. plastic	20
Bar Soap 1.5 oz	20	Water pills 10/strip AquaTAB*	40	Plastic/foam Plates	20
Band-aids, 1x3"	20	Petrolatum jelly tube 1 oz	1	Plastic Utensils, Fork	20
Flashlights	2	Can opener	10	Plastic utensils, Knife	20
Hand cleaner 2 oz.	20	Sauce pan	1	Plastic utensils, Spoon	20
Matches box	20	Push pins	1	Scrub Sponge	1
Splinter Forceps	1	Gloves, leather palm, pair	2	Zip Lock FREEZER Bag, 1 gal	40
Safety Pins Medium 124/box	1	Medium Tarp 12x20	1	Liquid Soap 6 oz	1
Eyewash 500 ml	1	Vise grip 10"	1	FRS/GMRS Motorola	
Triple Antibiotic Ointment Packet	20	Nylon rope 1/4" 50'	4	Radios T9500 AA	1
Nail Clipper	1	Radio am/fm	1	Knife	1
Tylenol Extra, 2/pk.	40	Cable Tie 15"	10	Elastikon 1"	1
Large Wound Pad 8x10	2	Bucket 5 gal.	1	Clip Board	2
3x4 Pad non Ahd	40	Baking Soda	1	SteriPen	1
2x3 Pad non Ahd	40	Stakes	10	Roll plastic sheeting	1
2" Gauze Roll	5	Duct Tape 50 yd	1		
4" Gauze Roll	5	Trash bags, 45 gal.	40		
EMT Shears	1	Trash bags Medium, 33 gal.	40		
Toilet Bucket w/Seat	1	Female supplies, MaxiPad	1		
Toilet Bags	33	Batteries AAA	6		
Triangular Bandage	1	Batteries AA	6		
Antibiotic ointment Tube	1	Batteries D	4		

*Items with a strikethrough have expired and will not be replaced. Use at your own risk

CASE STUDY B11: TILLAMOOK COUNTY

EMERGENCY VOLUNTEER CORPS OF NEHALEM BAY (EVCNB)

Tillamook County has an innovative community disaster cache approach called NEST Kits. NEST = Neighborhood Emergency Supplies and Tools.

NEST Kits are designed to meet the initial basic needs of a pre-identified and established group of about 50 neighbors, called a Cluster. The NEST Kit contains the supplies and instructions to establish four distinct disaster response basic needs stations in a neighborhood: Coordination & Communication, First Aid, Shelter, and WASH (water, sanitation and hygiene).



Project Coordination & Authority	They had a team of three volunteers (all members of the Emergency Volunteer Corps of Nehalem Bay) to spearhead and coordinate the effort. The team got letters of support from the Manzanita Mayor, 2 City Councilors, the Fire Chief, and the county Emergency Preparedness Coordinator as well as from several local businesses.
Purpose	Purpose: Response to Cascadia subduction zone earthquake and tsunami, or other disaster. Focus: The goal is to provide some basic supplies for the first 24 hours to keep people safe, dry, provide limited first aid, water, light, heat, and emergency communications ability. But no food; that was out of their scope. Clusters are encouraged to supplement these supplies to meet neighborhood needs.
Target Population	The NEST Kits are designed for established Clusters of about 50 people in Tillamook County, including visitors to the area who many not be prepared. A Cluster is a group of several blocks of neighbors organized and working together to get better prepared.
Model	Dispersed Supplies: Conveyed to a Specific Group
Ownership & Maintenance	There is no formal ownership. The emergency supplies are to be used for the greater good in a disaster situation. They are not insured. Each receiving team agreed to tend to the security, care, and maintenance of the NEST Kit, including an annual inventory, to check expiration dates, etc., and to do drills and training on the use of the materials in the NEST Kit.
Funding	The team received a grant from the Tillamook People’s Utility District Community Program Grant. With that grant and some supplementary supplies, they developed five NEST Kits. Each kit cost about \$1600. The group plans to apply for other grants to continue the program and distribute more NEST Kits.
Location, Storage Building & Security	NEST Kits are located in already defined and organized Prepare Your Neighborhood (PYN) clusters, in areas unlikely to be affected by a tsunami. The PYN program was developed by EVCNB to encourage emergency preparedness in the area. Each Cluster had to be ready to house the NEST Kit and secure it. Each Cluster found different places/ways to store the NEST Kits. None decided on shipping containers. Most got prefab shed kits, some are storing supplies in a garage, others bought a smaller garden-type storage shed/unit. The minimum space one would need to store the NEST boxes would be about 3’ x 6’. Each NEST Kit is under the direct control of the neighborhood cluster and needs to be secure (locked), and with access granted to multiple leaders of the group.
Contents	See some contents on next page and additional in the Task Cards in Appendix G.
Deployment	Each participating neighborhood can deploy the kits as needed during a disaster. Detailed Task Card Instructions are included in each kit.

B11: TILLAMOOK COUNTY, EMERGENCY VOLUNTEER CORPS OF NEHALEM BAY (EVCNB)

Keys to Success & Lessons Learned:

- **Team:** They had a small motivated team who led the effort, had support from local leadership, and enjoyed widespread community buy-in. They found that it is important to have clearly defined roles for the team organizing the effort. For example, determine who is best at what and passionate about what and have one person be in charge of the inventory list, grant, etc.
- **Research/Be Realistic:** Before buying supplies, they asked experts in their neighborhoods what would be needed for the first 24 hours for 50 people after an earthquake/tsunami. They had to determine what is realistic and reasonable to store. They imagined what the practical needs would be for that day: keeping people dry and warm, providing water, sanitation, and hygiene, and limited first aid. This exercise led to obtaining Bio Lite Stoves that can charge a cell phone when it generates enough heat, and privacy pop-up tents and portable toilets.
- **Organization:** The team leader explained, “The “stuff” is important, but the organizational framework is more important. 1) It is really important to be organized and intentional in your approach to developing the NEST Kits. If doing more than one NEST kit, you need space and you need people. Each kit has to be stocked and inventoried. Track everything and label everything very clearly. 2) It is also very important to have a clearly defined organizational structure for deploying the NEST Kits after an earthquake/tsunami.” They have an “Open This First” Box with instructions and Task Cards (see Appendix G), vests, names of positions, etc. There are very specific directions on what to do, how to immediately designate a leadership role, how to organize the response, and how to engage with spontaneous volunteers.



- **Purchasing:** They cautioned to be careful about the quality of the items you buy. Check websites for ratings and reviews. They use a site called Wirecutter.com. It rates stuff and they take a commission if you buy. Be very thoughtful about what you buy and be flexible with your budget. You may learn things as you go and pivot to buy other things you had not thought about originally.

Innovative Strategy:

- **WaSH (Water, Sanitation & Hygiene):** The WASH Box Kit and strategy was developed by the Emergency Volunteer Corps of Nehalem Bay. The [EVCNB](#) provides a comprehensive training class for their community on how to prepare for and operate the WaSH system in emergencies.

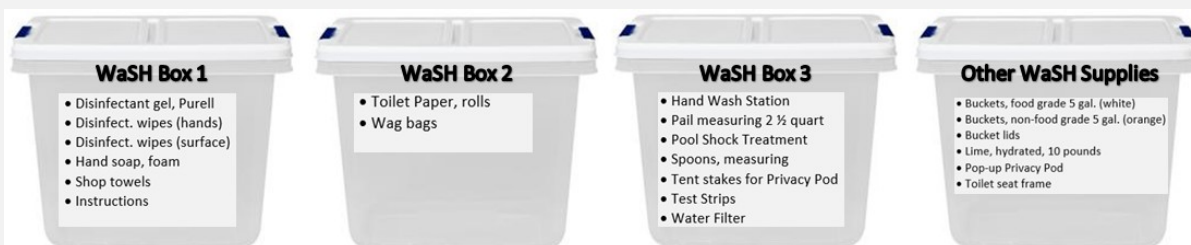

TEMPLATES

C1. Design Planning Worksheet

C2. Budget Worksheet

C3. Implementation Planning Worksheet

C4. Cache Inspection Form

C5. Conditions for Use Decision-Tree Template

C6. Task Card Template

C7. MOU Template

APPENDIX C: TEMPLATES

Overview: This section features several cache planning templates, worksheets, and forms that can be used or modified to meet the unique needs of a disaster cache planning team. Each template corresponds with the work planning teams perform during the four-step community disaster cache development planning process.

Step 1: Design:

- **Design Planning Worksheet:** to document foundational decisions made about the overall disaster cache design such as the team’s mission, the cache model, and the financial plan.
- **Budget Worksheet:** used in Steps 1 and 2 to figure out costs associated with developing a disaster cache.

Step 2: Implementation:

- **Implementation Planning Worksheet:** to record

decisions about where to locate the cache, what it will be stored in, how to secure the cache, and the specific supplies and equipment it will contain.

Step 3: Maintenance:

- **Cache Inspection Form:** assists in identifying how to manage the numerous maintenance aspects of a disaster cache.

Step 4: Deployment:

- **Conditions for Use Template:** provides a decision-tree format that can be used to identify and document criteria about when to open a disaster cache.
- **Task Card Template:** provides a model for how teams can present clear instructions for deploying items contained in the cache during a disaster.
- **MOU Template:** applies to all four steps of the planning process that involves partners who will play a role in funding, owning, maintaining, or providing a place to locate the cache.

C1. DESIGN PLANNING WORKSHEET

STEP 1: DESIGN PLANNING WORKSHEET				
PROJECT MANAGEMENT	PLANNING TEAM			
	AUTHORITY			
MISSION	HAZARDS & RISKS			
	CACHE PURPOSE			
	TARGET AUDIENCE			
CACHE MODEL	CACHE MODEL COMPONENTS			
	CACHE MODEL			
FINANCIAL PLAN	FUNDING			
	TIMELINE	YEAR	ACTIVITY	BUDGET
		1		
		2		
		3		
		4		
	5			

C2. BUDGET WORKSHEET

BUDGET WORKSHEET					
ITEM	DESCRIPTION	QTY	UNIT PRICE	TOTAL	VENDOR/NOTES
CACHE STORAGE BUILDING					
WATER					
SHELTER & WARMTH					
FOOD					
SANITATION					
MEDICAL					
SEARCH & RESCUE					
MISC					

C3. IMPLEMENTATION PLANNING WORKSHEET

STEP 2: IMPLEMENTATION PLANNING WORKSHEET		
CACHE LOCATION	MISSION ALIGNMENT	
	LAND USE REGULATIONS	
	HAZARDS & ACCESS	
	WRITTEN AGREEMENT	
STORAGE CONTAINER	TYPE & SIZE OF BUILDING	
	SITE PREP	
	BUILDING PREP	
SECURING THE CACHE	SECURITY	
	ACCESS CONTROL	
	SIGNAGE	
CACHE CONTENTS	SUPPLIES & EQUIPMENT	
	QUANTITIES	
	STORAGE & ORGANIZATION	

C4. CACHE INSPECTION FORM

CACHE INSPECTION FORM				
'Yes' responses typically indicate good conditions. 'No' responses indicate potential areas in need of maintenance.				
Date of Inspection:		Names of Inspection Team:		
EXTERIOR STRUCTURE		YES	NO	NOTES
1	Is the building clear of tree limbs, branches, foliage, or other obstructions?			
2	Is the building on level ground (examine for ground settling and tipping)?			
3	Is the building free of rust, rot, holes, graffiti, or other damage or wear?			
4	Is the building secured (examine for tampering or break-ins)?			
5	Are the locks and doors easy to open and in good condition?			
6	Are cameras or motion detector lights free of cobwebs and grime, and functioning correctly?			
7	Other:			
INTERIOR ENVIRONMENT		YES	NO	NOTES
8	Is the interior free of moisture, leaks, water drops on ceiling or walls?			
9	Is the interior free of mildew or other odors?			
10	Is the interior free of signs of pests, rodents, or droppings?			
11	Do the interior lights work?			
12	Other:			
CONTENTS		YES	NO	NOTES
13	Are the contents in their normal storage place (examine for tipping over)?			
14	Does the inventory list match up with the actual supplies in the cache?			
15	Do the contents appear to be in good condition and free of damage?			
16	Are all contents within established use dates (examine for expired items)?			
17	Other:			
Actions Taken during Inspection: (repairs made, contents rotated, etc.)				
Actions Needed after the Inspection:				

C5. CONDITIONS FOR USE TEMPLATE

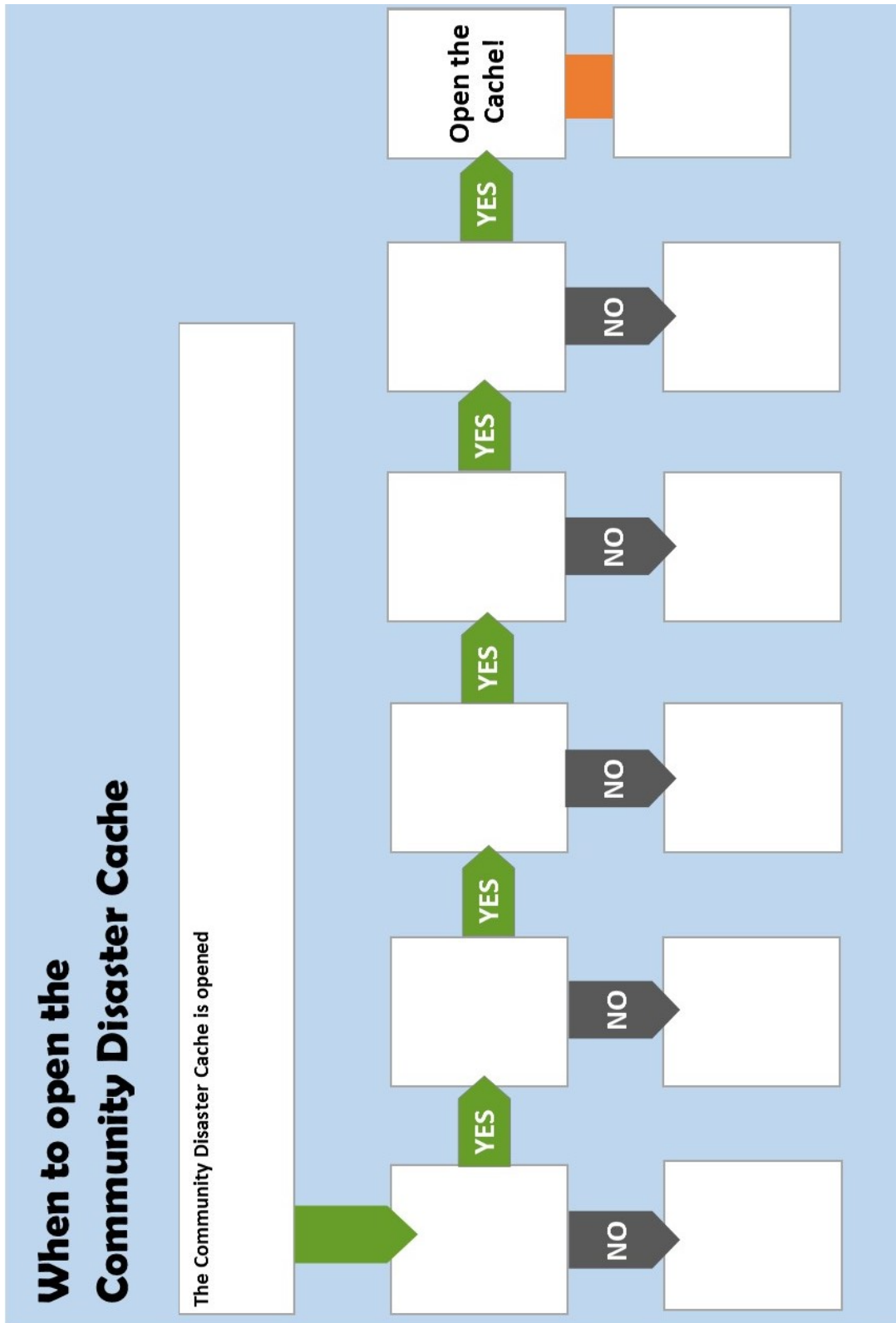

C6. TASK CARD TEMPLATE

NAME OF TASK:			
ASSIGNED TO:			
REPORT TO:			
Supplies & Equipment Needed:	<ul style="list-style-type: none"> • • • • • 	<ul style="list-style-type: none"> • • • • • 	<ul style="list-style-type: none"> • • • • •
<u>INSTRUCTIONS:</u>			
<ul style="list-style-type: none"> • • • • • • • • • • • 			
<u>NOTES:</u>			
<ul style="list-style-type: none"> • • • • 			

C7. MOU TEMPLATE (EXAMPLE)

Memorandum of Understanding Community Disaster Cache

Parties: This Memorandum of Understanding (MOU) is made by and between the following “Parties”:

- [Name of City], hereafter referred to as “City”;
- [Name of Fire & Rescue District], hereafter referred to as “Fire”;
- [Name of Neighborhood or School District], hereafter referred to as “HOA or School”.

Purpose: The purpose of this MOU is to identify parameters around the development, location, ownership, maintenance, and use of a Community Disaster Cache, hereafter referred to as “Cache”.

Assumptions: Just off the Oregon and Washington Coast lies the Cascadia subduction zone which is capable of producing a magnitude 8 or 9+ earthquake with several minutes of intense shaking and then destructive tsunami waves and surges for 10-12 hours or more. When this event occurs, coastal communities will be cut off from normal transportation routes due to bridge failures, landslides, and tsunami inundation. Communities will need to survive on their own for days and possibly several weeks without our normal infrastructure of water, sewer, electricity, transportation, food, and communications. In addition, many buildings will suffer severe damage from the initial earthquake and aftershocks, leaving people without shelter.

Mission: To establish a Cache of basic survival supplies (including but not limited to [shelter, water, & food]) that will aid [*survivors who assemble near the Cache*] in a catastrophic disaster such as a large earthquake and tsunami.

Agreements:

- **Project Coordination:** A team consisting of 1-2 members from each participating organization will comprise the Cache Project Management Team. [*Name of Party*] will order the shipping container and the agreed-upon cache equipment and supplies and will account for all funds expended. [*Name of Party*] will prepare the ground for the shipping container and will coordinate its delivery, placement, and security. [*Name of Party*] will insulate the container and install shelves. [*Name of Party*] will fill the water barrels, label supplies, and load the container.
- **Funding:** Each Party will contribute [\$_____] toward the initial Cache development. The Cache Project Management Team will attempt to seek out additional funding through grant opportunities. The Team will then work with all Parties to secure funding for the completion of the Cache.
- **Ownership:** The Cache will be considered jointly owned property by all Parties participating in this MOU. The joint ownership will be considered undividable; if a Party withdraws from participation in the Cache MOU, the ownership remains with the remaining Parties in this

C7. MOU TEMPLATE, CONTINUED

agreement. If all Parties withdraw, the Parties participating at the time of dissolution shall jointly agree upon the distribution and or disposal of the remaining Cache.

- **Location:** The cache will be located at *[Name of Location]*. There will be no initial or ongoing fees for storing the container at this location. *[Name of Party]* will insure the cache. If at such time in the future the cache needs to be relocated, the parties will work together to secure a new location. Depending on the location, insurance obligations may be adjusted.
- **Access:** All parties will have keys to the Cache and will have unlimited access for purposes of inventory, training, maintenance, or disaster emergency needs. If space is available in the containers, parties may store additional disaster supplies in them and will provide an inventory of supplies to the other Parties.
- **Maintenance:** *[Name of Party]* will conduct an annual inspection of the exterior and interior of the shipping container and will maintain the shipping container. *[Name of Party]* will conduct an annual inspection of the contents of the cache and will maintain the contents, including changing the water in the water barrels every 5 years and replacing the water purifier solution.
- **Deployment:** In a disaster situation when communication capabilities are limited or unavailable, no formal mechanism is needed for deployment of cache resources. Parties can take independent action to deploy cache resources as they are able to get to it and as needed. There will be an Operations Manual inside the Cache that Parties deploying the Cache will attempt to implement, depending on conditions. While this project has been developed largely for the response to a Cascadia subduction zone earthquake, all parties recognize the possibility that other emergencies or disasters may occur requiring the use of this cache. In that case, Parties agree to attempt to make communications with other parties to inform of disposition of Cache.
- **Replacement:** Parties using the cache will attempt to reclaim supplies that can be reused and restore them to the cache for future disaster use. If cache supplies are used for a disaster, parties will attempt to seek reimbursement from FEMA or other organizations offering support to help replace the inventory of the cache that is not reusable.

Terms: This MOU becomes effective upon approval of all Parties as signed below, and remains in effect until cancelled in writing by any Party. This MOU may be reviewed, changed, or modified periodically. Nothing in this agreement shall be construed as inputting liability on any Party based solely on participation in this agreement. All Parties agree that the procedures in this MOU are not mandatory in their application, but are a recommended and preferred approach to developing, managing, and deploying a Cache.

Approval of Parties:

Name (print)

Organization

Signature

Date

SAMPLE AGREEMENTS

D1. Berkeley Application & Letter of Understanding

D2. Gearhart Memorandum of Understanding & Addendum

D3. Joyce (JEPP) Proposal, Resolution, and Memorandum of Understanding

D4. Seaside Letter of Understanding

D5. Memorandum of Understanding Template

APPENDIX D: SAMPLE AGREEMENTS

Overview: This section features a variety of written agreements, applications, and resolutions that correspond with existing disaster cache projects featured in the Case Studies in Appendix B. When developing a community disaster cache that involves partnerships, it is critical to have written agreements that spell out the responsibilities of each partner including the location, funding, ownership, and maintenance of the cache. This section provides examples of such agreements that planning teams can draw from as they work to develop agreements that meet the unique needs of their project.

D1. The City of Berkeley Community Emergency Supply Program is an example of a “Dispersed Supplies” cache model. Featured is an *Application* to have the supplies conveyed to a specific group and a *Letter of Understanding* for after a group has been approved to receive the emergency supply cache.

D2. The City of Gearhart’s Emergency Cache Container Program is an example of a “Storage for Residents’ Supplies” cache model. Featured is a *Memorandum of*

Understanding (MOU) for residents wishing to participate in the program and store their supplies in the City’s cache, and an *Addendum* that enacts changes to the original MOU.

D3. The Joyce Emergency Planning and Prep Disaster Cache is an example of a “Standalone Disaster Cache.” Featured is a *Proposal* to the County Commissioners to establish a Joyce Emergency Cache; a *Resolution* stating that the Joyce Fire Department Auxiliary will sponsor the establishment and maintenance of a cache; and a *Memorandum of Understanding* (MOU) between multiple groups concerning the development of a disaster cache.

D4. The City of Seaside’s Tsunami Barrel Program is an example of a “Dispersed Supplies” cache model in which the barrels of supplies are stored in residents’ homes. Featured is a *Letter of Understanding* identifying each party’s responsibility concerning the storage and long-term maintenance of a tsunami emergency supply barrel.

D5. The MOU Template is an example of language that could be used or modified to address partner roles such as funding, owning, maintaining, or providing a location for a “Standalone Disaster Cache.”

D1: CITY OF BERKELEY

APPLICATION FOR FY2020 COMMUNITY EMERGENCY SUPPLY PROGRAM

Return by May 29, 2020, 5:00 p.m.

After a catastrophic earthquake, government resources (people and supplies) may not be available for several days. It is essential that every household, family, neighborhood and building resident be prepared to survive for five to seven days until utilities and services can be restored. The criteria below reflect the standards of a prepared neighborhood/group. Please score your neighborhood/group's level of preparedness as accurately as possible.

Name of Neighborhood Group, Apartment Building, or Association(s): _____

Neighborhood, Apartment Building or Association Coordinator(s) Name: _____

Address _____ **Zip** _____ **Phone** _____ **E-mail** _____

Addresses covered: _____

Number of Households: _____ **Number of neighborhoods involved:** _____

Length of time organized for disaster preparedness: _____

QUALIFYING CRITERIA 1. Your group has been organized for at least three years or demonstrate group organization and sustainability; 2. Your group has satisfied at least **six of the nine** steps of becoming a disaster resistant neighborhood; 3. Your group has at least **eight people** trained and formed into Disaster Medical Operations, Fire Safety, and Light Search and Rescue teams.

CRITERIA: CERT TEAMS Please fill in the number of persons trained or qualified.

CORE CERT TEAMS:

		Enter numbers below:	This Column for Staff Use
	Points/Person	No. Persons Qualified	Total Points/Neighborhood
CERT* Disaster medical Operations. <i>Minimum of 4 persons</i>	4		
CERT* Fire Safety. <i>Minimum of 4 persons</i>	4		
CERT* Light Search and Rescue. <i>Minimum of 4 persons</i>	4		
CERT* Organization. <i>Minimum of 2 persons</i>	4		
DESIRABLE ADDITIONAL TEAMS/SKILLS			
CERT* Disaster Mental Health	1		
CERT* Shelter Operations	1		
CERT* Pandemic Influenza	1		
Professional Medical Training	1		
Professional Fire Suppression Training	4		
Professional Trauma Counseling Training	1		
Construction Skills Useful in a Disaster	1		
Qualified Ham Radio Operation	4		
Total points for CERT Teams/skills			

*Individuals either must be currently registered in or have completed training since 2006.

D1. BERKELEY APPLICATION, CONTINUED

CRITERIA: EIGHT STEPS. Answer YES or NO for each neighborhood preparedness component completed.

Attach details/explanation if necessary.:

BASIC PREPARATIONS

	Possible Points	YES or NO	This Column for Staff Use Points/ Neighborhood
Coordinator(s) per 30-50 households and regular Meetings established.	3		
Designated neighborhood/building emergency supply location and emergency assembly point.	2		
Established phone tree communication plan.	3		
Assessment of level of neighborhood/building preparedness, including 3 days food/water per household & emergency supplies and tools. Give percentage of prepared households.**	___%**		
Neighborhood/building hazard assessment complete.	3		
Map of gas and water shut-off valves developed and team assigned to check and turn off as needed.	2		
List of neighbors requiring special assistance in a disaster.	1		
Neighborhood/building supplies and materials stored.	8		
DESIRABLE ADDITIONAL PREPAREDNESS			
Home or building earthquake retrofitting. Give percentage of houses.**	___%**		
Extra points for involving surrounding neighborhoods in planning efforts.	5/block		
Total Points for neighborhood or building group.			

**1-25% of households=1 pt.; 26-50%=2 pts.; 51-75%=3 pts.; 76-100%=4 pts.

Grand Total of points for Individuals + Neighborhood Group (Staff Use Only)	
--	--

Final determination to be made by City Staff	This column for Staff Use
I (we) understand that the level of neighborhood/building preparedness is one of three criteria used to determine the award of supply caches. Other factors include: providing an even distribution of equipment throughout the City, and a risk assessment for potential sites as determined by the Fire Department.	
Geographical Distribution	
Risk Assessment	

Signed _____

Date _____

Return to: City of Berkeley Fire and Emergency Services
 2100 Martin Luther King, Jr. Way
 2nd Floor – C/O OES/Community Emergency Supply Program
 Berkeley, CA 94704

D1. BERKELEY LETTER OF UNDERSTANDING

LETTER OF UNDERSTANDING

LETTER OF UNDERSTANDING BETWEEN _____ AND THE CITY OF BERKELEY

This agreement, entered into this ____ day of _____, constitutes a Letter of Understanding (“LOU”) between the City of Berkeley (“CITY”) and the _____ (“NEIGHBORHOOD/GROUP”) regarding the pre-placement of containers filled with emergency supplies in designated areas of each Council District as a precautionary measure in the event of a disaster.

I. BACKGROUND

As a result of the 1989 Loma Prieta Earthquake, the 1991 East Bay Hills Fire, and the 2005 Hurricane Katrina tragedy, the Mayor and City Council accelerated disaster planning throughout the City. An important component of that planning is the availability of emergency supplies should a catastrophic disaster occur, and the City’s neighborhoods and Apartment Building groups are an integral component of disaster planning. In a catastrophic disaster, government resources (people and supplies) may not be available for several days following the event. It is essential that every household, family, apartment tenant and neighborhood be prepared to survive for five to seven days until utilities and services can be restored.

In addition to providing for the emergency needs of the City’s residents, supplies located in the neighborhoods would greatly assist the City’s response to local disasters. The City and NEIGHBORHOOD/GROUP have established and wish to continue a partnership to provide emergency containers with basic medical, search and rescue and other supplies for such an occurrence. The City will provide the initial supplies and the container to store the supplies to the NEIGHBORHOOD/GROUP without charge. By executing this agreement, the NEIGHBORHOOD/GROUP acknowledges that all members of the NEIGHBORHOOD/GROUP have been or will be made aware by the undersigned NEIGHBORHOOD/GROUP representative that participation in the NEIGHBORHOOD/GROUP is voluntary, and that certain tasks could involve lifting objects, operating vehicles, and other miscellaneous activities that occur in making voluntary preparations for a disaster, and possibly taking voluntary action during a disaster. Except as specifically provided for in this agreement, by providing these emergency supplies and containers, the City does not create any continuing obligation to provide additional supplies or containers in the future.

II. DEFINITION, USE AND RESPONSIBILITIES

A. Disaster Defined: For purposes of this LOU, a disaster shall mean the actual or threatened existence of conditions of disaster or of extreme peril to the safety of persons and property within the City, caused by such conditions as fire, flood, storm, epidemic, toxic hazards, earthquake, or other conditions as declared by the City including conditions resulting from war or imminent threat of war, but other than conditions resulting from a labor controversy which conditions are or are likely to be beyond the control of the services, personnel, equipment and facilities of the City.

D1. BERKELEY LETTER OF UNDERSTANDING, CONTINUED

B. Purposes and Use of Emergency Supplies: The primary purpose of the City of Berkeley's Supplemental Emergency Supply Program is to provide backup emergency equipment to serve the greatest number of residents in the event of an emergency/disaster. The provided containers shall only be used for emergency supplies and equipment. City emergency response personnel may use container contents for purposes of managing a local emergency.

C. Responsibilities: NEIGHBORHOOD/GROUP Responsibilities:

1. Non-disaster: Identify site and host the supplies in secure area; Maintain emergency supplies; Replace supplies when used; Hold regular meetings to plan for emergencies; Identify up to three individuals responsible to hold keys and who will be responsible for opening the container. Complete regular CERT training to maintain skills and ability to use equipment, refreshing every three years. Hold annual neighborhood/building based disaster drills.

2. Post-Disaster Response Recovery: Use container supplies to support the City's response efforts in a coordinated manner. Use equipment to serve the greatest number of residents in your group. Develop teams to assess neighborhood/building needs and provide equipment for teams to use, e.g. search and rescue, fire suppression, medical, sheltering, etc. Use communication equipment to communicate with each other (two way radios), with other cache sites. Maintain situation status board to track activity and location of resources and responders; Maintain command post until no longer needed; Communicate with the Berkeley Fire Department when they are able to come and assist with rescue efforts.

III. Ownership of Cache Supplies:

A. The containers and their contents are owned by the hosting NEIGHBORHOOD/GROUP. The NEIGHBORHOOD/GROUP agrees to host the cache indefinitely and use it for the purposes identified above. Should the NEIGHBORHOOD/GROUP determine they are no longer able to maintain the cache, the NEIGHBORHOOD/GROUP shall contact the Berkeley Fire Department to reassign the cache to another qualifying neighborhood/group in the same District.

B. Should an emergency occur in the nearby area deeming it necessary, in the City's sole discretion, to use the cache supplies, the City may access and use the supplies for the emergency, and call on the residents to assist. In that event, the City is responsible for replacing the supplies used for that emergency.

IV. Who uses supplies? The supplies are intended to serve the NEIGHBORHOOD/GROUP's residents under the leadership of the NEIGHBORHOOD/GROUP. If necessary, the City may use the supplies in an emergency.

V. How the supplies will be used: To carry out response and recovery efforts in disasters and for training purposes.

D1. BERKELEY LETTER OF UNDERSTANDING, CONTINUED

VI. How the containers will be accessed: The NEIGHBORHOOD/GROUP will hold keys for the containers. The containers may be accessed by at least three individuals holding keys in the hosting neighborhood or building.

VII. Maintenance of containers and supplies: NEIGHBORHOOD/GROUP shall maintain the containers and supplies, including efforts to avoid such problems as leakage and pest infestation, in order to prolong their use as storage bins for emergency supplies. Both parties recognize that any built structure has a useful, but inevitable lifespan. Security of the container and supplies is a recognized consideration of maintenance. NEIGHBORHOOD/GROUP shall secure the container and supplies from theft and damage with the best efforts practicable. The NEIGHBORHOOD/GROUP is responsible for replacing supplies that are damaged or lost due to theft. Nothing in this agreement shall mandate additional expenditures by the NEIGHBORHOOD/GROUP or City. Supplies used for emergencies shall be replaced in a timely manner by the entities that use them, either by the City or the hosting NEIGHBORHOOD/GROUP.

VII. Standard Supplies Inventory: A suggested basic inventory of supplies has been developed by the City in order to ensure that appropriate supplies are available for disasters. (See attachment A).

IX. Disclaimer – (legal)

A. Entire Agreement: The terms and conditions of this LOU, all exhibits attached and any documents expressly incorporated by reference represent the entire LOU between the parties with respect to the subject matter of this LOU. This LOU shall supersede any and all prior agreements, oral or written, regarding the subject matter between the City and NEIGHBORHOOD/GROUP. No other contract, statement, or promise relating to the subject matter of this LOU shall be valid or binding except by a written amendment to this LOU.

B. Severability: If any part of this LOU or the application thereof is declared invalid for any reason, such invalidity shall not affect the other provisions of this LOU which can be given effect without the invalid provision or application, and to this end the provisions of this LOU are declared severable.

C. Amendments: The terms and conditions of this LOU shall not be altered or otherwise modified except by a written amendment to this LOU which can be given effect without the invalid provision or application, and to this end the provisions of this LOU are declared to be severable.

IN WITNESS WHEREOF, _____ NEIGHBORHOOD/GROUP and City have executed this LOU as of the date written in the first paragraph of this Agreement.

NEIGHBORHOOD OR GROUP

By _____
CITY MANAGER

D2. CITY OF GEARHART



THE CITY OF GEARHART
EMERGENCY CACHE CONTAINER PROGRAM
MEMORANDUM OF UNDERSTANDING



This Memorandum of Understanding (the “MOU”) is made on mm/dd/yyyy, by and between [resident name(s).....], of [address.....] and **The City of Gearhart**, of 698 Pacific Way, Gearhart, OR 97138, (the “Parties”) for the purpose of establishing an understanding of expectations pertinent to involvement in the City’s community *Emergency Cache Container Program* (the “Program”).

WHEREAS, the Parties desire to enter into an agreement to engage in mutual emergency preparation and hazard mitigation through Program participation;

WHEREAS, the Parties desire to memorialize certain terms and conditions pertaining to the Program;

NOW, THEREFORE, in consideration of agreements contained herein, the Parties agree as follows:

Objective: The purpose of this MOU is to provide the framework for participation in the Program.

Obligations: The Parties acknowledge that no contractual relationship is created between them by this MOU, but agree to work together in the spirit of partnership to ensure cooperation and to demonstrate a communal, administrative and financial commitment to the Program through execution of the following itemized Program participation requirements:

- a. Items [resident name(s).....] will adhere to include:
 - Self-purchase drum from a local retailer, online vendor, or other _____ (initials)
 - Only a 30-gallon drum will be allowed _____ (initials)
 - Only a polyethylene (plastic) drum WITH lid will be allowed _____ (initials)
 - Drum measurements *cannot* exceed: 29-30” H x 18-20” D _____ (initials)
 - Drum weight *unfilled* may not exceed: 14-16 lbs _____ (initials)
 - Gasoline, kerosene, (contaminable) plastic water bottles are **excluded** _____ (initials)
 - A \$40 storage fee will be paid to the City annually _____ (initials)

- b. Items the City of Gearhart will adhere to include:
 - Store zip sealed drum in locked Conex bin _____ (initials)
 - Provide locked gate security _____ (initials)
 - Provide security camera surveillance _____ (initials)
 - Provide drum access dates twice a year (April/October) _____ (initials)
 - Enlist CERT to assist with the un/loading of drum during access dates _____ (initials)
 - Track drum through numbering system and other identifiers _____ (initials)

Term: The Program runs annually. Conex/drum access will only occur *once* in April and *once* in October.

Payment: The annual cost is \$40. We accept cash, check (payable to: *City of Gearhart*), or credit/debit card (+3%).

D2. GEARHART MOU, CONTINUED

Unique Circumstances: [resident name(s).....] assert the following instruction for their cache drum in the event it has not been claimed during a catastrophic incident after *a reasonable period of time* has passed due to reasons including, but not limited to, prolonged missing persons designation, abandonment, or death.

- _____ is named to take possession of my drum _____ (initials)
- (mark & initial ONE) If no person named in this MOU claims my drum, **The City of Gearhart:**
 - May distribute my drum to people in need _____ (initials)
 - May NOT distribute my drum to people in need _____ (initials)

Termination: The named resident(s) own both the drum and items therein. Therefore, a resident may pull their drum from the Program at any time. The annual fee will not be prorated and/or refunded for early termination requests. Requests to terminate any time other than an April or October access date will be assessed a \$300 fee to cover time, Conex access, and drum retrieval. This fee will go toward future emergency preparation projects. The City also reserves the right to remove a resident from the Program for non-payment of the annual fee, and/or including excluded items within their drum.

Disclosure: As previously defined, the City cannot guarantee individuals will promptly receive their cache drum, especially in the event of tsunami. The Program is meant to aid during the recovery phase. *It is imperative individuals prepare a 72-hour (minimum) Go Bag* to sustain themselves during the immediate aftermath of any catastrophic event.

Liability: No liability will arise or be assumed between the Parties as a result of this MOU.

Understanding: Both Parties have read this document in its entirety and understand all required Program obligations.

Signatories: The signatures below demonstrate mutual agreement and official participation in the Program:

RESIDENT NAME(S)

CITY OF GEARHART

Signed: _____

Signed: _____

By: _____

By: _____

Date: _____

Date: _____

OFFICE USE ONLY:

Barrel # _____ **S/N** _____ **Last Name** _____ **House #** _____

(check) **PAID** **Date:** _____ **Method:** CC# x _____ * CK# _____ * (circle) CASH

D2. GEARHART CONTINUED



THE CITY OF GEARHART
EMERGENCY CACHE CONTAINER PROGRAM
MEMORANDUM OF UNDERSTANDING
CHANGE ADDENDUM



This Addendum is part of the City’s community *Emergency Cache Container Program* (the “Program”) Memorandum of Understanding (the “MOU”) as it relates to the signed understanding of expectations between [resident name(s).....] and **The City of Gearhart** (the “Parties”).

Objective: The purpose of the Addendum is to grant changes/additions to the MOU concerning Program renewal, and/or cache access privileges, and/or unique circumstances as indicated in the marked sections below.

Obligations: The Parties acknowledge this Addendum makes no changes to the itemized Program participation requirements agreed upon within the primary MOU.

Program Renewal: The Program runs annually. Conex/drum access will only occur *once* in April and *once* in October. You will renew your Program term during one of these access date events. Are you renewing today?

YES – MM/YYYY _____ NO

Cache Access Privileges: The named resident(s) own both the drum and items therein. At their discretion, they may or may not choose to allow other family or community members to access their cache drum for various reasons.

YES, GRANT OTHERS ACCESS [fill out below] NO ADDITIONAL ACCESS GRANTED

[resident name(s).....] assert the following named individual(s) have permission to access their cache drum during cache sitewide access dates and/or make decisions regarding its contents:

1. _____ 2. _____ 3. _____

Unique Circumstances: YES, CHANGES MADE BELOW NO CHANGES [primary MOU stands]

[resident name(s).....] assert the following instruction for their cache drum in the event it has not been claimed during a catastrophic incident after a *reasonable period of time* has passed due to reasons including, but not limited to, prolonged missing persons designation, abandonment, or death.

- _____ is named to take possession of my drum _____ (initials)
- (mark & initial ONE) If no person named in the MOU or Addendum claims my drum, **The City of Gearhart:**
 - May distribute my drum to people in need _____ (initials)
 - May NOT distribute my drum to people in need _____ (initials)

D2. GEARHART ADDENDUM, CONTINUED

Payment Reminder: The annual cost is \$40. We accept cash, check (payable to: *City of Gearhart*), or credit/debit card (+3%).

Termination Reminder: The named resident(s) own both the drum and items therein. Therefore, a resident may pull their drum from the Program at any time. The annual fee will not be prorated and/or refunded for early termination requests. Requests to terminate any time other than an April or October access date will be assessed a \$300 fee to cover time, Conex access, and drum retrieval. This fee will go toward future emergency preparation projects. The City also reserves the right to remove a resident from the Program for non-payment of the annual fee, and/or including excluded items within their drum.

Disclosure: As previously defined, the City cannot guarantee individuals will promptly receive their cache drum, especially in the event of tsunami. The Program is meant to aid during the recovery phase. *It is imperative individuals prepare a 72-hour (minimum) Go Bag* to sustain themselves during the immediate aftermath of any catastrophic event.

Liability: No liability will arise or be assumed between the Parties as a result of this Addendum.

Understanding: Both Parties have read this document in its entirety and understand the changes.

Signatories:

RESIDENT NAME(S)

CITY OF GEARHART

Signed: _____

Signed: _____

By: _____

By: _____

Date: _____

Date: _____

OFFICE USE ONLY:

Barrel # _____ **S/N** _____ **Last Name** _____ **House #** _____

(check) **PAID** **Date:** _____ **Method:** CC# x _____ * CK# _____ * (circle) CASH

D3. JOYCE PROPOSAL, RESOLUTION, & MEMORANDUM OF UNDERSTANDING

Proposal to County Commissioners

August 28, 2015

Joyce Fire Dist. No. 4
P.O. Box 106
Joyce, WA 98343

Dear Board of Commissioners,

I am writing to propose that Fire District 4 permit the placement of a 40-foot shipping container at Station #1 in Joyce. This container will permit the community to stockpile emergency supplies for use in a Red Cross shelter to be set up in Joyce in the event of an emergency.

Recent news reports indicate that western Washington faces the threat of a magnitude 9.2 Cascadia Subduction Zone (CSZ) Earthquake. No one can predict when this will happen but it has happened approximately every 250 to 500 years in the past. The last CSZ earthquake occurred on January 26, 1700, 315 years ago.

FEMA studies predict cataclysmic damage from the quake and ensuing tsunami. Bridges, highways, water systems and communications are estimated to be out of service for months. The Joyce area between the Elwha River and Lyre River is expected to be cut off from the rest of Washington. FEMA does not expect meaningful supplies of food, medicine, fuel and other products to arrive in less than 3 weeks. Voluntary evacuation to other parts of the country may not be possible for up to a month.

This means citizens will have to shelter in place until help arrives. Most people who live here are prepared to be cutoff for a few days a year by the annual storms we encounter. However, there is no plan to open a shelter for those whose homes are damaged or who are unable to care for themselves.

Some members of the Joyce community would like to establish a cache of supplies. These supplies would be available to set up an American Red Cross shelter in Joyce during a disaster.

The plan is in its infancy. The shelter would be set up in the least damaged frame structure available after the earthquake to avoid the expense of tents. The cache could be located in a 40-foot shipping container at Clallam County Fire District #4, Station 1. This location provides security and ready access.

The list of supplies, itemized on the attached proposal, comes from a similar plan adopted by the Snohomish County PUD. It includes first aid kit, search and rescue supplies, water, food, cots, blankets, sleeping bags, sanitation supplies and fuel. The cost to do this is estimated to be \$15,000. This will provide food, water and shelter for up to 100 people for 5 days.

Additional supplies for more people and longer time periods can be added as funds become available in coming years. I hope you will approve this proposal so planning for the project can proceed.

Sincerely,



Jim Buck

D3. JOYCE, CONTINUED

RESOLUTION NO. 2: 2015

Resolution to Establish a Joyce Emergency Cache

WHEREAS: Article 1.2 of the Joyce Fire Department Auxiliary bylaws states, “the purpose for which the auxiliary is organized to further the welfare of the volunteers ... and to promote the ability of the Clallam County Fire District No. 4 to provide effective and efficient service ... to the public.”

AND, WHEREAS: Article 1.3 of the Joyce Fire Department Auxiliary Bylaws state, “... this Joyce Fire Department Auxiliary is organized exclusively for charitable and educational purposes, including, for the purposes, the making of distributions to organizations that qualify as exempt organizations under section 501c3.”

AND, WHEREAS: Fire District No. 4 may experience a major earthquake at any time that would isolate the community from outside assistance,

AND, WHEREAS: Joyce Fire Department Auxiliary is capable of assisting in the education and preparation its volunteers and the public to survive the earthquake,

THEREFOR, BE IT RESOLVED, The Joyce Fire Department Auxiliary will sponsor the establishment and maintenance of a cache of emergency supplies at Station 1, Fire District 4.

ARTICLE 4.2

The cache will be maintained in a locked and secure 40’ shipping container. The supplies will be used to establish shelter in surviving frame structures in the community. The shelter will be equipped to Red Cross Standards. Supplies for the cache may be obtained using the Joyce Fire Department Auxiliary 501c3 non-profit exemption. Expenditures for cache supplies will be pre-approved by vote of the Auxiliary members. The accounting for shelter income, inventory and expenditures will be maintained and reported as a sub category of the reports required by Bylaws Article 3.5. The incident commander has authority to open and implement the shelter plan.

PASSED AND ADOPTED BY AUXILIARY MEMBERS at a regular meeting thereof this 26th day of September 2015

D3. JOYCE, CONTINUED

MEMORANDUM OF UNDERSTANDING (MOU)

Memorandum of Understanding Between Clallam County Fire District #4, Joyce Fire Department Auxiliary, and the American Red Cross Chapter serving Kitsap and Olympic Peninsula Counties Concerning the Placement, Maintenance and Care of Disaster Relief Supplies

The Clallam County Fire District #4 (CCFPD#4), Joyce Fire Department Auxiliary (JFA), and the American Red Cross Chapter serving Kitsap and Olympic Peninsula Counties, a non-profit 501(c)(3) entity chartered by the American Red Cross (“Red Cross”) have reached an understanding as follows:

Whereas, the parties have determined that there is a need to stockpile and stage disaster relief supplies throughout Clallam County for use by disaster responders for purposes of caring for citizens during a disaster:

Whereas, the parties understand that by de-centralizing and pre-positioning disaster relief supplies in various centralized community locations throughout Clallam County, the issuance of disaster relief supplies during times of a declared disaster or localized emergency will be expedited;

Whereas, the parties understand that government, citizens and non-governmental organizations must coordinate response and recovery in an effort to make the best use of limited resources and avoid duplication of services:

Whereas, the parties understand that there may be disaster events in the region so devastating that transportation and communication services are so disrupted and affected community members and localized regions may find it necessary to engage in sheltering and other community support; and

Whereas, the parties enter into this memorandum of understanding to provide for the health, safety and welfare of the citizens of the Clallam County.

IT IS UNDERSTOOD THAT:

1. Definitions

- a. The Clallam County Fire District #4 owns the shipping container (storage room) and insures the contents on CCFD#4 property. CCFD#4 command is authorized to open the container and distribute supplies only in case of a localized emergency or declared disaster.
- b. Joyce Fire Department Auxiliary (JFA) is a separate entity of volunteers who provide services for CCFD#4. JFA is responsible for purchasing and maintaining Disaster Relief Supplies stored in the storage room.
- c. Storage Room: forty foot 40’ shipping container located at CCFPD#4 Station #1 in Joyce (coordinates N48.13458 and W123.72882).
- d. Disaster Relief Supplies: Goods and materials used to permit disaster victims to recover from the effects of a disaster. Examples of such materials include, but are not limited to, cots, blankets, paper and hygiene products, forms and documentation, and related items. An inventory list will be kept by the Joyce Fire Department Auxiliary and the Carlsborg Red Cross Office.
- e. Localized Emergency: A man-made or naturally occurring disaster event which results in the displacement of citizens in the community, but which does not affect such a number of people that would necessitate the enactment of the county disaster plan.
- f. Declared Disaster: A declared disaster is one which receives official recognition from city, county, state, or federal government because of the magnitude of the disaster or the number of people affected by the event.

D3. JOYCE MOU, CONTINUED**2. Storage**

- a. The Red Cross has purchased various Disaster Relief Supplies for storage in the Storage Room (40' shipping container) located at CCFPD#4 Station #1 in Joyce along with Disaster Relief Supplies owned by JFA. JFA will maintain an inventory of Red Cross Disaster Relief Supplies separate from those provided by JFA.
- b. The CCFPD#4, as owner of the container and property will maintain the shipping container, electricity, outside fencing and security.
- c. The JFA will maintain the Storage Room contents including supplies owned by the Red Cross. Maintenance includes that level of care which preserves the integrity and usability of any and all Disaster Relief Supplies stored within the Storage Room, including keeping access points where the Disaster Relief Supplies are placed free and clear of debris or other limitations which would prevent unfettered access in the event of an emergency. The Red Cross reserves the right to remove and relocate the Red Cross Disaster Relief Supplies stored in the Storage Room that, due to its condition, risks the integrity and usability of the Red Cross Disaster Relief Supplies.
- d. If CCFPD#4 needs to move the Storage Room to a new location, JFA will notify the Red Cross as soon as possible of the conditions which required Storage Room to be moved.
- e. If JFA needs to move the Disaster Relief Supplies to a new location, JFA will notify the Red Cross as soon as possible of the conditions which required the supplies to be moved. The Auxiliary will, if possible, obtain written permission from the Red Cross prior to any such relocation of the Red Cross Disaster Relief Supplies. If the Red Cross needs to move its Disaster Relief Supplies to a new location, the Red Cross shall notify JFA as soon as possible of the conditions which required the Red Cross Disaster Relief Supplies to be moved.
- f. JFA will work with the Red Cross to maintain and keep the Storage Room contents usable and current at all times. If the Red Cross Disaster Relief Supplies stored in the Storage Room are removed and used for a Localized Emergency or a Declared Disaster, the Red Cross agrees to replenish any used Red Cross supplies as soon as reasonably possible to re-establish site integrity.
- g. JFA shall provide Red Cross access to the contents of the Storage Room during Disaster Relief Operations. Should the Red Cross need access to the Red Cross Disaster Relief supplies outside of normal business hours, the Red Cross will notify CCFD#4 who will in turn notify JFA which will provide access and an escort to the Storage Room and its contents.
- h. The CCFPD#4 and JFA may use the Red Cross Disaster Relief Supplies after a Declared Disaster has been proclaimed. This declaration must come from the Clallam County Department of Emergency Management, Washington State Department of Emergency management, or the federal government. Red Cross Disaster Relief Supplies may be used in a localized emergency with the permission of the Red Cross. If the Red Cross Disaster Relief Supplies are used without this declaration or Red Cross permission, it is the responsibility of JFA to replenish the Red Cross Disaster Relief Supplies with items of equal quality that are approved by the Red Cross as soon as possible to re-establish site integrity. There may be times that the Disaster Relief Supplies are used prior to a disaster being declared, but once the declaration is made, it then becomes the responsibility of the Red Cross to replenish the Disaster Relief Supplies as soon as possible to re-establish site integrity.

D3. JOYCE MOU, CONTINUED

3. Hold Harmless

- a. The Red Cross shall protect, indemnify and save harmless the CCFPD#4 and JFA, its officers, elected officials, agents, volunteers and employees from any and all costs, claims, judgments or awards of damages (including costs and all attorney fees), arising out of or in any way resulting from the negligent acts, errors or omissions of the Red Cross, its officers, elected officials, agents, volunteers and employees in performing this Memorandum of Understanding.
- b. CCFPD#4 and JFA shall protect, defend, indemnify and save harmless the Red Cross, its officers, elected officials, agents, volunteers and employees from any and all costs, claims, judgments or awards of damages (including costs and all attorney fees), arising out of or in any way resulting from the negligent acts, errors or omissions of CCFPD#4 and JFA, its officers, elected officials, agents, volunteers and employees in performing this Memorandum of Understanding.

4. Notices: All notices required to be given under the terms of this Memorandum of Understanding shall be sent in writing and or hand delivered to the parties at the addresses below:

- Clallam County Fire District #4 Station #1, PO Box 106, Joyce, WA 98343.
- AMERICAN RED CROSS CHAPTER SERVING KITSAP AND OLYMPIC PENINSULA COUNTIES, 811 Pacific Ave, PO Box 499, Bremerton, WA 98337
- Joyce Fire Department Auxiliary, PO Box 106, Joyce, WA 98343.

5. Severability: The invalidity of any provision of this Memorandum of Understanding, as determined by a court of competent jurisdiction, shall in no way affect the validity of any other provision herein.

6. Term: The term of this Memorandum of Understanding shall commence on the date of the final signature of all parties and be subject to annual review on the final signature date. This Memorandum of Understanding will remain in effect unless a request for modification or termination is sent to the other party, in writing, with at least a 60-day notice.

The parties agree to the provisions above and will adhere to them during the course of this Memorandum of Understanding. This Memorandum of Understanding supersedes and replaces all previous agreements.

Clallam County Fire District #4 _____ Date ___/___/___

Joyce Fire Department Auxiliary _____ Date ___/___/___

American Red Cross Chapter serving _____ Date ___/___/___
Kitsap and Olympic Peninsula Counties

D4. CITY OF SEASIDE LETTER OF UNDERSTANDING



THIS LETTER OF UNDERSTANDING is made between the City of Seaside (City) and the volunteer generously offering to provide storage space for emergency supply cache barrel No. _____,

Printed Name of Property Owner / Email Address

Printed Street Address / Mailing Address if different / Phone Number

CIRCUMSTANCES

The City, through its Tsunami Preparedness Program, is working to provide emergency supply caches within high ground areas throughout the City of Seaside. This is in preparation for a major evacuation resulting from a local earthquake that could be followed by a major tsunami inundation or other major disaster. In recognition of the above named Property Owner’s generous and voluntary offer to provide storage space for a supply cache barrel, the following responsibilities are understood:

Responsibilities of City:

- Deliver the supply barrel(s) to the Property Owner.
- Provide written notice to the Property Owner at least 30 days prior to scheduling a reasonable time to conduct routine annual maintenance of the supply cache barrel(s).
- Arrange to pick up the supply cache barrel(s) upon cancellation of this Letter of Understanding.

Responsibilities of Property Owner:

- Provide a dry, convenient, & relatively safe location for storing a City supply cache barrel(s);
- Allow City access to the stored barrel, following written notice, in order to conduct annual maintenance, check the cache, & rotate items subject to a shelf life.
- Allow access to the supply cache barrel(s) without written notice from the City in the event of a major evacuation resulting from a local earthquake accompanied by a major tsunami inundation or other major disaster.
- Notify the City if the property is sold or the Property Owner is no longer willing to meet the responsibilities stated herein.

Hold Harmless: Each party to this Letter of Understanding shall hold harmless the other, its officials, agents and employees from losses arising from its performance of this agreement.

Effective Date and Duration: This agreement shall become effective upon both parties’ signature of this Letter of Understanding. The duration of this agreement shall be ongoing until either party cancels the same upon written notice to the other 30 days in advance of cancellation.

Signature of Property Owner

Mark J. Winstanley, City Manager

Date

Date

D5. MEMORANDUM OF UNDERSTANDING (MOU) TEMPLATE - EXAMPLE

Memorandum of Understanding Community Disaster Cache

Parties: This Memorandum of Understanding (MOU) is made by and between the following “Parties”:

- [Name of City], hereafter referred to as “City”;
- [Name of Fire & Rescue District], hereafter referred to as “Fire”;
- [Name of Neighborhood or School District], hereafter referred to as “HOA or School”.

Purpose: The purpose of this MOU is to identify parameters around the development, location, ownership, maintenance, and use of a Community Disaster Cache, hereafter referred to as “Cache”.

Assumptions: Just off the Oregon and Washington Coast lies the Cascadia subduction zone which is capable of producing a magnitude 8 or 9+ earthquake with several minutes of intense shaking and then destructive tsunami waves and surges for 10-12 hours or more. When this event occurs, coastal communities will be cut off from normal transportation routes due to bridge failures, landslides, and tsunami inundation. Communities will need to survive on their own for days and possibly several weeks without our normal infrastructure of water, sewer, electricity, transportation, food, and communications. In addition, many buildings will suffer severe damage from the initial earthquake and aftershocks, leaving people without shelter.

Mission: To establish a Cache of basic survival supplies (including but not limited to [shelter, water, & food]) that will aid [*survivors who assemble near the Cache*] in a catastrophic disaster such as a large earthquake and tsunami.

Agreements:

- **Project Coordination:** A team consisting of 1-2 members from each participating organization will comprise the Cache Project Management Team. [*Name of Party*] will order the shipping container and the agreed-upon cache equipment and supplies and will account for all funds expended. [*Name of Party*] will prepare the ground for the shipping container and will coordinate its delivery, placement, and security. [*Name of Party*] will insulate the container and install shelves. [*Name of Party*] will fill the water barrels, label supplies, and load the container.
- **Funding:** Each Party will contribute [\$_____] toward the initial Cache development. The Cache Project Management Team will attempt to seek out additional funding through grant opportunities. The Team will then work with all Parties to secure funding for the completion of the Cache.
- **Ownership:** The Cache will be considered jointly owned property by all Parties participating in this MOU. The joint ownership will be considered undividable; if a Party withdraws from participation in the Cache MOU, the ownership remains with the remaining Parties in this

D5. MOU TEMPLATE, CONTINUED

agreement. If all Parties withdraw, the Parties participating at the time of dissolution shall jointly agree upon the distribution and or disposal of the remaining Cache.

- **Location:** The cache will be located at *[Name of Location]*. There will be no initial or ongoing fees for storing the container at this location. *[Name of Party]* will insure the cache. If at such time in the future the cache needs to be relocated, the parties will work together to secure a new location. Depending on the location, insurance obligations may be adjusted.
- **Access:** All parties will have keys to the Cache and will have unlimited access for purposes of inventory, training, maintenance, or disaster emergency needs. If space is available in the containers, parties may store additional disaster supplies in them and will provide an inventory of supplies to the other Parties.
- **Maintenance:** *[Name of Party]* will conduct an annual inspection of the exterior and interior of the shipping container and will maintain the shipping container. *[Name of Party]* will conduct an annual inspection of the contents of the cache and will maintain the contents, including changing the water in the water barrels every 5 years and replacing the water purifier solution.
- **Deployment:** In a disaster situation when communication capabilities are limited or unavailable, no formal mechanism is needed for deployment of cache resources. Parties can take independent action to deploy cache resources as they are able to get to it and as needed. There will be an Operations Manual inside the Cache that Parties deploying the Cache will attempt to implement, depending on conditions. While this project has been developed largely for the response to a Cascadia subduction zone earthquake, all parties recognize the possibility that other emergencies or disasters may occur requiring the use of this cache. In that case, Parties agree to attempt to make communications with other parties to inform of disposition of Cache.
- **Replacement:** Parties using the cache will attempt to reclaim supplies that can be reused and restore them to the cache for future disaster use. If cache supplies are used for a disaster, parties will attempt to seek reimbursement from FEMA or other organizations offering support to help replace the inventory of the cache that is not reusable.

Terms: This MOU becomes effective upon approval of all Parties as signed below, and remains in effect until cancelled in writing by any Party. This MOU may be reviewed, changed, or modified periodically. Nothing in this agreement shall be construed as inputting liability on any Party based solely on participation in this agreement. All Parties agree that the procedures in this MOU are not mandatory in their application, but are a recommended and preferred approach to developing, managing, and deploying a Cache.

Approval of Parties:

Name (print)	Organization	Signature	Date
--------------	--------------	-----------	------

INNOVATIVE STRATEGIES

E1. Commode System & Latrine Trench Design

E2. Portable Water Treatment Plant & Field Kitchen

E3. Rainwater Collection Strategy

E4. Seattle Posters

E5. Toilet Paper Storage Strategy

E6. Water Heater Siphon

APPENDIX E: INNOVATIVE STRATEGIES

Overview: This section features six innovative strategies others have developed and incorporated into their community disaster cache projects or community disaster preparedness initiatives.

Planning Teams may find inspiration in these strategies as they work to customize plans according to their own unique situations.

E1. Commode System & Latrine Trench Design

The Coastal Cache team developed an innovative strategy for managing human waste involving a trench and commode system.

E2. Portable Water Treatment Plant and Field Kitchen

The Joyce Emergency Planning and Prep (JEPP) team went above and beyond developing traditional community disaster caches and implemented a more robust and innovative strategy for supplying safe food and water to their community during a disaster.

E3. Rainwater Collection Strategy

Kay Wyatt, a local earthquake and tsunami preparedness champion, designed a creative rainwater collection and distribution system for her neighborhood that uses a simple but effective four-step process: water collection, treatment, storage, and delivery.

E4. Seattle Posters

Seattle Emergency Communications Hubs volunteers developed five *Self Help Posters* to help prepare their community members for disasters. These posters could be laminated and stored in a community disaster cache for distribution during a disaster.

E5. Toilet Paper Storage Strategy

The JEPP team developed an innovative strategy for determining how much toilet paper to plan for and recommendations for long-term storage of toilet paper.

E6. Water Heater Siphon Instructions

The Depoe Bay Fire District CERT leaders developed step-by-step instructions and a simple kit for using a home water heater as an emergency water supply.

E1. COMMODE SYSTEM & LATRINE TRENCH DESIGN

The Coastal Cache team developed an innovative strategy for managing human waste. It is designed to serve their surviving community members for a lengthy period of time after an earthquake and tsunami when traditional sewer systems are not operational.

Coastal Cache Commode System & Latrine Trench Design

Instructions:

- 1. Dig a Trench:** Use the long-handled shovels to dig the latrine trenches not too far away from the tents and the cache, in a safe and water-free open space. See the “Aerial Photo for Latrine Trench” for possible locations near the Clubhouse. Dig the trenches running East to West so that the prevailing winds minimize odor. Dig the first trench at the end farthest from the Clubhouse so that as it fills, the next trench can be dug parallel and in front of the first trench and so on. The “Latrine Trench Design” shows the recommended size of the trench to be dug, and the recommended placement of the Commodes. If you encounter solid rock when digging the trench, abandon the trench and dig where infiltration into soil is possible. Place the excavated soil next to trench area not in use. The soil will be used to cover waste after each commode use. Install orange fencing and/or caution tape along trench length outside of commode platforms.

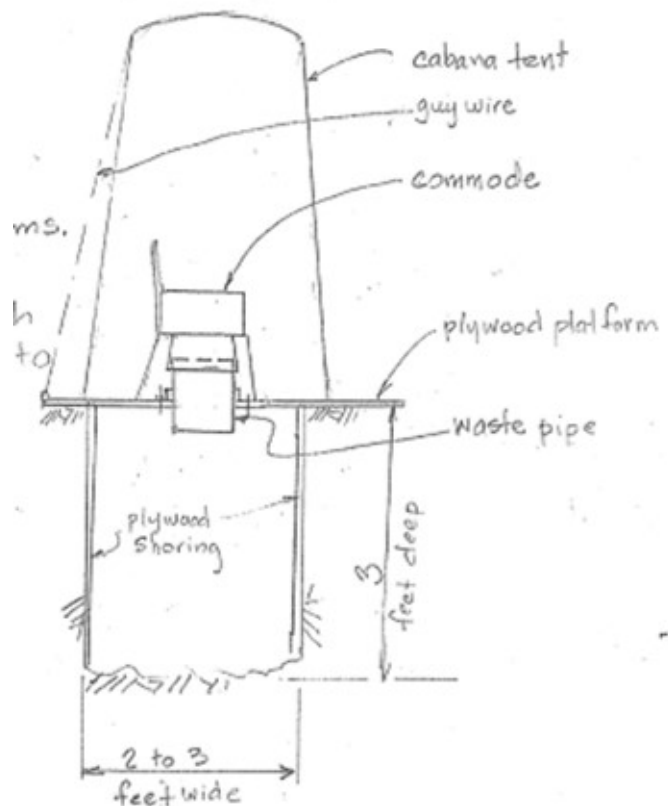

- 2. Assemble Commode Platform:** There are two plywood platforms to be used as the base for the Commodes. Place the plywood platforms across the trenches with the hardware up. There are two metal pipes to be attached to the platforms to channel the waste into the trench. Using the screws and screwdriver and the “L” brackets, attach the “A” pipe to “A” platform and the “B” pipe to “B” platform.

E1. COMMODE SYSTEM & LATRINE TRENCH DESIGN, CONTINUED

3. Install the Shelter/Cabana Tents: There are two shelter/cabana tents to be placed over the plywood platform to provide privacy and shelter. Assemble the shelter/cabana tents on the plywood platform. Notice the four corners of each tent need to be secured to the platform. Attach the “s” hooks on the platform to the “o” rings on the tent. Then attach the three yellow guy wires to the three “7” hooks situated at the back (center) and two side (centers). Use the waterproofing spray to protect the seams of the shelter. Tarps are available for additional shelter if needed.

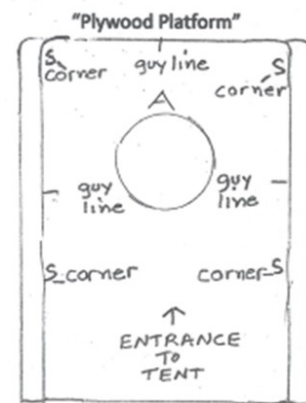

4. Set the Commodes in Place: Place the two commodes in the shelter/cabana tents. Set the open-bottomed gray buckets into the frame of the commodes and set both over the waste pipes so that the bucket rests in the frame of the commode and in the metal waste pipe. Secure the bucket to the frame of the commode with duct tape.

5. Prepare Sand Buckets: Fill two 3-gallon buckets with the sandy soil from the trench excavation. Place one of the buckets in each shelter along with a sand shovel for use as needed. When the trench under the waste pipe fills with waste, slide the commode assembly to an unused portion of the trench.

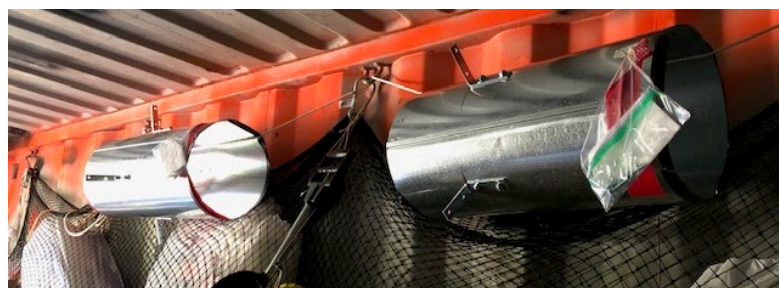

Supplies & Equipment

Trench	Commode Platform	Shelter & Commode	Misc.
4 long-handled shovels 4 sheets Plywood for shoring	2 Plywood platforms 2 Metal waste pipes 4 L Brackets Phillips screwdriver & screws 2 Open-bottom buckets	2 Shelter/cabana tents 5 hooks & O rings Guy wire & hooks 2 Commodes 2 3-gallon buckets 2 sand shovels	Duct tape Toilet paper Orange fencing or caution tape Aerial photo for possible trench locations

E1. COMMODE SYSTEM & LATRINE TRENCH DESIGN, CONTINUED

Additional Drawings & Dimensions:

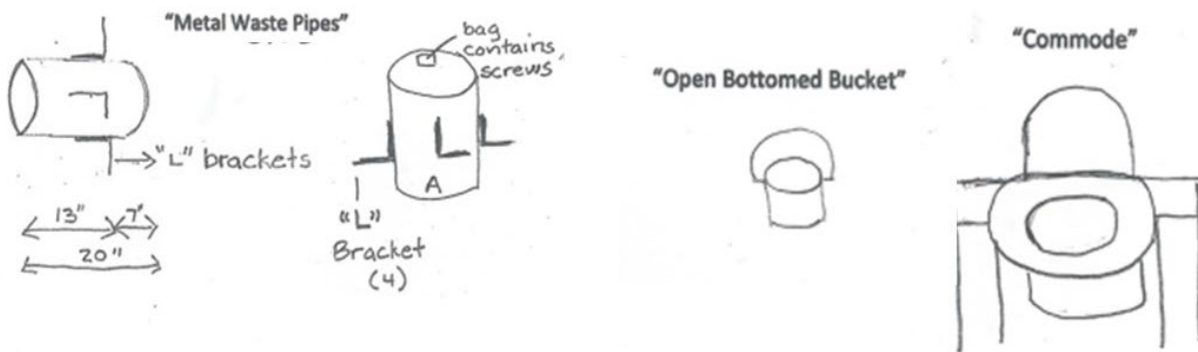
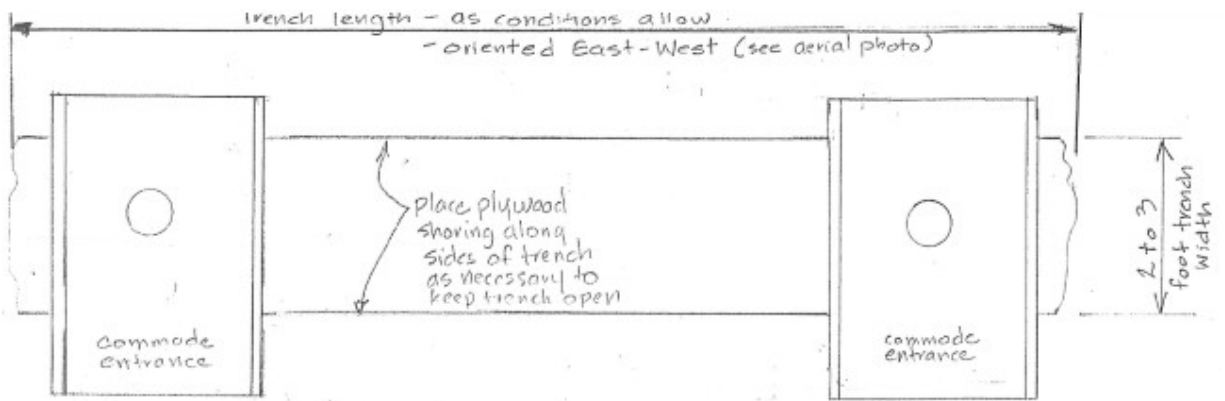

PLYWOOD PLATFORM

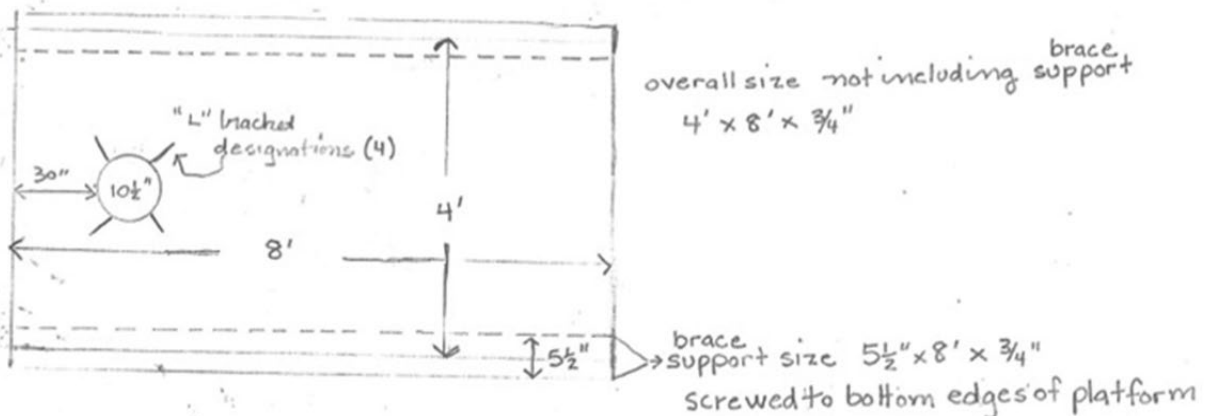

E2. PORTABLE WATER TREATMENT PLANT & FIELD KITCHEN

The [Joyce Emergency Planning and Prep \(JEPP\)](#) team went above and beyond developing traditional community disaster caches and implemented a more robust and innovative strategy for supplying safe water and food to their community during a disaster. Photos courtesy of Jim Buck.

Portable Water Treatment Plant

The JEPP water treatment plant is similar to an [Aquamira DIVY 250 Emergency Water Purification System](#). The JEPP plants are trailer mounted, have 2 additional filters and multiple storage containers. Both have hand and electrical pumps. The dosage of calcium hypochlorite and contact time meets Washington Health Department standards. The JEPP water system complies with instructions on the [Environmental Protection Agency's \(EPA\) website](#) about Ground Water and Emergency Disinfection of Drinking Water. Those wishing to build similar emergency plants should consult their local health departments. NOTE: JEPP is only sharing their solution to their local problem. They have numerous sources of clear water and their system is designed to avoid turbid conditions.



Field Kitchen

This is a surplus US Army MKT-99 Field Kitchen trailer. This self-contained unit is designed to feed 300 people per meal. It has curtains, screens, and skirting to provide weather and insect protection. Stairs and safety rails allow people access to a serving line on one side of the trailer. The unit has two ovens, two ranges, and a large griddle. The Quileute and Makah Tribes conveyed four of these units to the JEPP Emergency Cache Project. The food, packaged in buckets, is from [Auguson Farms](#) and has a 30-yr shelf-life. JEPP has enough food to serve 300 people for 8-weeks.



E3. RAINWATER COLLECTION STRATEGY

Kay Wyatt, an earthquake and tsunami preparedness champion from the Pacific Northwest, designed a creative rainwater collection and distribution system for her neighborhood that uses a simple but effective 4-step process: water collection, treatment, storage, and delivery. Supplies and equipment used are identified in the photos below.

Rainwater Collection System

Collect

Treat

Store

Deliver

Supplies Needed

- Tarp or plastic sheeting
- Rope, bungee cords, posts
- Rainwater collection barrel (brown)
- Spigot & tubing
- 5-gallon buckets & lids
- Sawyer Water Filter
- 55-gallon barrel, bung wrench, and pump
- Platform hand truck

- 1. Collect:** Use rope or bungee cords to hang a tarp or plastic sheeting from trees, fences, or poles. Cut a small hole in the center of the tarp. Position the brown 50-gallon Rain Barrel with the grated lid underneath the hole in the tarp to capture the rainwater.
- 2. Treat:** Attach a spigot to a 5-gallon bucket. Use tubing to attach the [Sawyer Water Filtration System](#). Transfer water from rain barrel to the 5-gal bucket. Use the *Sawyer Water Filter* to purify the water.
- 3. Store:** Direct the output of the *Sawyer Water Filter* into the Blue 55-gallon water barrel for storage of the purified water.
- 4. Deliver:** Using the red pump, transfer water from the blue barrel into the white buckets. Use the platform hand truck to deliver water in two 5-gallon white buckets with lids.

Suncast Corp 50-Gallon Rain Barrel
RB5010PK
Brand: Suncast

5 Gallon White Plastic Bucket Only - Durable 90 Mil All Purpose Pail - Food Grade Buckets

2 PACK Bottling Bucket Plastic Spigot, Replacement Spigot

Sawyer Products MINI Water Filtration System
Visit the Sawyer Products Store

55 Gallon Blue Water Barrel | Solid Mold 1/2 Inch Bung Holes, Good for Long Term Use

Heavy Duty Plastic Bung Nut Wrench for Barrels

Food Grade BPA Free Emergency Disaster 55-Gallon Drum Pump Heavy Duty Barrel Siphon/Drinking Water Hand Pump

Magna Cart Platform 300 lb Capacity Four Wheel Folding Platform Truck

APPENDIX E: INNOVATIVE STRATEGIES

152

E4. SEATTLE POSTERS

Seattle Emergency Communications Hubs volunteers developed [Self Help Posters](#) to help prepare their community members for disasters. “In those first few days when information will be hard to get, these posters remind people of basic information so they can stay safe. There are five posters for the following topics: Communication, Food Safety, Water Safety, Hazards and Sanitation.” These posters could help disaster cache planning teams with ideas about the items they may store in their cache to meet specific basic needs. Teams could also decide to store laminated quantities of these or customized posters in their cache for distribution during a disaster.

WATER

Water Requirements

Drink per day:
1/2 gallon = 2 quarts = 8 cups



Do not ration water.
Drink what you need today.
Find more for tomorrow.

Drink more in hot weather or with exertion.



Allocate another 1/2 gallon for cooking and personal hygiene.

HOW MUCH DO YOU NEED FOR A DAY?



8 cups per person for drinking

4 cups per person for washing





4 cups per person for cooking

Water Sources

Turn off your water supply at the street shut-off valve or where the water main enters your house.



Water Heater Tank

- Turn off power or gas line to water heater.
- Turn off cold water supply at the water heater.
- Allow water to cool down.
- Attach hose or bucket to drain valve.
- Open a hot water faucet elsewhere in the house.
- Open the drain valve. Expect some sediment.
- Purify if water quality is questionable.



Other Sources

- Melted ice from freezer
- Canned fruit or vegetable juice
- Toilet tank

Do not drink from the toilet bowl.



How to Purify Water

Boiling (best)

- Filter water first with cloth or coffee filter.
- Boil water for 1 minute at a rolling boil. **Boil for 1 minute (60 seconds)**
- Allow to cool before use.



Bleach

- Use regular concentrated formula bleach, not scented or with added chemicals.
- Filter water first with cloth or coffee filter.
- Mix 1/8 teaspoon (about 8 drops) per gallon of water.
- Double this for cloudy water.
- Wait 30 seconds.
- Water SHOULD have a VERY SLIGHT bleach odor.



Purification will not remove fuel or chemicals.
DO NOT drink water contaminated by fuels or chemicals.

More Info

© 2008 Seattle Emergency Communications Hubs. All rights reserved. This poster is for informational purposes only. It is not intended to be used as a substitute for professional advice. For more information, visit [www.seattleemergency.com](#).

E4. SEATTLE POSTERS, CONTINUED

FOOD

Cooked Foods Last Longer

- If your food begins to defrost, immediately cook what you can to preserve it longer.
- Dehydrate food if you have the tools.

Food Safety is Critical

- Eat perishable foods first
- See below for information on specific food groups
- Dairy products are highly perishable.
- Eggs will last 1-2 weeks.

Share Storage Resources

- Work with neighbors to share cooling equipment and generators to keep food safe.
- Pool perishable food with neighbors and share to eat first.

Do not use gas or charcoal grills to cook inside—it can cause Carbon Monoxide poisoning. Keep food prep areas clean with a bleach solution. Wash hands or use hand sanitizer often.

DURING

WHILE THE POWER IS OUT...



Keep the refrigerator and freezer doors **CLOSED to HOLD IN THE COLD.**

- If it is hot outside, food will spoil faster.
- Use your nose and eyes—if food smells bad or looks like it is getting moldy, **THROW IT OUT!**
- **DO NOT TASTE** food to see if it is ok!

IF DOORS STAY CLOSED...

... a fridge may keep food safe for up to **4 HOURS**

... a full freezer will hold its temperature for **48 HOURS**

... if half full a freezer will hold its temperature for **24 HOURS**

Once perishable food is at 40° or above:

Toss after 4 hours:



Keep until nose/eyes detect decay:

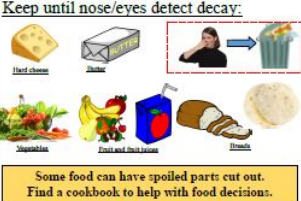

Some food can have spoiled parts: cut out. Find a cookbook to help with food decisions.

SANITATION





Do not bury or burn poo.

Twin Bucket Emergency Toilets Need:

- 2 five-gallon buckets
- 2 lids for the buckets
- Toilet paper
- Hand sanitizer

For Poo bucket:

- Plastic bags
- Toilet seat or rim padding
- 3 gallons filler (shredded paper, sawdust, cat litter)

Directions:

- Mark one bucket "pee" and one bucket "poo".
- Use buckets separately if possible (try not to mix pe and poo.)
- Line poo bucket with plastic bag x 2
- Add some filler material to the bottom of the poo bucket.
- After using the poo bucket, sprinkle as much filler as needed to completely cover the surface of the poo. This reduces odors and keeps flies away.
- Do not overfill the plastic bags,
- Put all used toilet paper into the poo bucket.
- Urine can be spread on grass or gardens.
- See Waste Disposal section for poo removal.

WASTE DISPOSAL





- Secure plastic bags with gooseneck tie.
- Place tied bags in areas away from people and secured from rodents.
- Disinfect hands and areas of accidental waste contact.

Disinfectant and Cleaning



- Clean contaminated surfaces with bleach solution.
- Always clean hands after handling waste.

E4. SEATTLE POSTERS, CONTINUED

COMMUNICATION

911

If you need emergency help, CALL 9-1-1

If you cannot reach 9-1-1,

- Try to get help from a neighbor.
- Wait 10 minutes before calling 9-1-1 again.
- Walk to your nearest police or fire station.

If possible, stay off your phone!
Keep circuits clear for emergency calls.

Cell Phones

Texting and messaging apps will work better than voice calling.

Preserve your battery power:

- Use battery saver or airplane mode
- Dim screen as much as possible
- Turn off wi-fi if you do not have data
- Turn off Bluetooth

Recharging Stations located at:

“I Am Safe” Tools

Put up notes at home or work to let people know your status.

If you can, use “I am safe” online sites to let people know your status:

American Red Cross:
Safeandwell.communityya.org/iafsafe/ddd

Facebook: [Facebook.com/crisisresponse/](https://www.facebook.com/crisisresponse/)

Google person-finder widgets set up by organizations

Contact Family or Friends Out of Area

Inform family members of your location. Ask them to tell others for you.

Keep your cell charged.

Feel change of your status in the internet when needed.

Do not post rumors or unofficial information.

Your **LANDLINE PHONE** may work when power is out; plug it directly into wall jack to bypass electrically-powered base.

Official announcements, if available, may be found on these radio stations:

	KOMO: 97.7 FM & 1000 AM KIRO: 97.3 FM & 710 AM	KEXP: 90.3 FM KUOW: 94.9 FM
Others: <input style="width: 100%;" type="text"/>		

HAZARDS

Natural Gas Supply

- Leaking gas can explode, causing fires.
- DO NOT enter or immediately leave a house that smells of natural gas (rotten egg smell).
- Gas is leaking if you can smell it, hear hissing, or see the dial on your gas meter spinning.

If it is leaking:

- Use a wrench or other tool to turn the valve on the gas meter 1/4 turn so the valve head crosses the intake pipe. It may be hard to turn.
- Do not use power tools or anything that would cause a spark near the gas meter.

DO NOT turn off the gas unless it is leaking! The gas company must turn it back on for you, and it may be a long time until they get to you.

Electrical Hazards

Report any electrical pole fires to 911 or fire station.

DO NOT flip live electrical switches in a home where there might be a gas leak; sparks could cause an explosion.

Unplug small appliances, and things not plugged into a protected power strip. Leave on a light so you know when power returns.

ALWAYS treat downed wires as LIVE—even if you think the power is out—stay at least 20 feet away!

Beware of Buildings with Visible Damage

After an earthquake, there may be aftershocks which can cause further damage—check out buildings before re-entering!

Chimneys

- Inspect your chimney for damage.
- Brick chimneys will be weakened by shaking and may collapse in an aftershock.
- If your chimney is damaged, stay away.
- Do not use your fireplace until the chimney has been inspected.

Slope Failure

- Be aware of regions where slope failure is predicted. Aftershocks or worsening conditions may cause delayed slope failure.

Structural and Safety Placards

- Green and Yellow Placards, when inspections can take place, will tell you to what extent your building can be occupied.
- Red Placards: No entry under any circumstances!

E5. TOILET PAPER STORAGE STRATEGY

The [Joyce Emergency Planning and Prep \(JEPP\)](#) team developed an innovative strategy for determining how much toilet paper to plan for and recommendations for long-term storage of toilet paper.

JEPP Toilet Paper Storage Strategy

Required rolls per person per day: In an average household, the average roll of toilet paper lasts approximately five days. Most people use the toilet 6-7 times a day, but 4-10 times can also be "normal." People use an average of 57 sheets or squares of toilet paper a day. These calculations are based on the finding that each person will need around 0.27 rolls of toilet paper a day. Usage will vary of course and dormers with intestinal and other issues will use more, impacting the JEPP supply, so our projected daily use calculation will be higher than 0.27 rolls/day.

We'll want to give shelter clients a helpful point of reference. A good rule of thumb for toilet paper usage is **4-5 squares** of medium-quality or 2-ply tissue paper at a sitting. Any more than this for a single use becomes a bit wasteful and unnecessary. However, we must accept that JEPP toilet paper will also be used by shelter clients for such everyday tasks as cleaning eyeglass lenses, removing makeup, blowing noses and occasionally for wiping up a variety of substances.

Required rolls per person per week: Most people use between one and two rolls of TP each week. So, at 2 rolls per week per person for 300 clients and workers, were looking at about **600 rolls per week** and **2,400 per month**. These figures may be on the low end, as some research indicates individual usage is 3 rolls per week, but it's a reasonable starting point.

Toilet paper longevity: Toilet paper can last for **years or even decades** if it's stored properly. It will last the longest when it's stored somewhere that is cool and dry, or if it's sealed in a watertight container. However, it can rot and grow moldy when it's exposed to the elements. We'll want to seal the TP in air tight trash bags with 55-gallon drums (in our steel storage shed) and sealed totes (on the top shelf in Conex #2).

Roll size: The diameter or girth of a single roll varies, but it usually measures between 4.0 and **5.5 inches**. The standard size of one roll of Safeway's Value Corner toilet paper is **4.0" x 4.0"**. The number of two-ply sheets in this brand's roll is 315. Safeway sells its Value Corner toilet tissue for \$5 per 12 pack, or for 42 cents per roll. This may not be our final choice, but it's a good place to start. We may even get Safeway to give us a better price for a bulk order.

- **Safeway's Value Corner bathroom tissue**
 - \$5 per 12 pack x sixteen 12 packs per 50-gallon tote
 - \$83 to fill one tote with 200 rolls
 - \$36 per blue Sterilite tote
 - \$119 per sealed stackable unit
 - Three totes to fill the need for 300 people in a single week = \$357 per week
 - Twelve totes to meet the need for 300 people for four weeks = \$1,428



E5. TOILET PAPER STORAGE STRATEGY, CONTINUED

Storage: JEPP should consider storing toilet paper in steel drums and lidded containers in several locations. Calculations below are based on rolls 4" in girth and 4" tall (see Safeway Value Corner brand above). If we chose to use the blue containers (shown below), we could accommodate our need in two nine-foot tall stacks (18" per tote x 6 totes = 108 inches or nine feet). Alternatively, we could store the toilet paper in three stacks of four containers, with each stack 72" or six feet high.

Lidded Totes: Lidded totes offer the best protection against rodent and insect infestation - if their contents are properly wrapped in thick plastic, if moth balls are added, and if the containers themselves are carefully sealed. **This is the Recommended Option.**

- **Sterilite Totes** [in stackable totes]
 - Large 50 gallon stacking bin box
 - \$107 for tote pack of 3 at ebay
 - Heavy duty, lidded, lockable, stackable
 - L 39.75 x W 21.50 x H 17.88 Inches
 - Each will hold 200 4 x 4" rolls of TP
 - 4 layers @ 10 rolls by 5 rolls = 200 rolls per
 - We'll need three totes for each week's supply
 - Sterilite totes will maximize protection



Alternative Options:

Boxed Toilet Paper: Boxed bulk purchases of toilet paper could be wrapped in heavy plastic and stacked similarly, but this would provide only one layer of protection, would require more effort, and may not reduce costs.









- **Tork** [as an example]
 - Product SKU: TRKTM6120S
 - Advanced 2-Ply Toilet Paper Rolls
 - 500 Sheets per roll
 - 96 Rolls per carton
 - \$48 per carton
 - 50 cents per roll
 - Sealing boxes like this from moisture, rodents and insects may prove difficult.



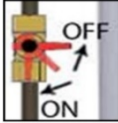

55-Gallon Drums: We may want to consider using donated, clean 55-gallon drums for TP storage. Packed carefully within liners, the toilet paper can be compressed to maximize space. Each drum ought to be able to hold 240+ rolls of 4" x 4" TP. The drums' steel lids would be secured with gaskets and bolt-tightened steel bands protecting the contents from rodents, insects and outside moisture.

E6. WATER HEATER SIPHON INSTRUCTIONS

[Depoe Bay Fire District CERT](#) trainer, Susan Graves, collaborated with local plumber and tsunami preparedness planner, Steven Kutsch, to develop step-by-step instructions for using a home water heater as an emergency water supply. They assembled simple, inexpensive kits using a gallon Ziplock bag containing a 10' length of clear plastic tubing (1/4" ID x 3/8" OD) with these printed instructions.

EMERGENCY WATER SUPPLY ~ WATER HEATER SIPHON INSTRUCTIONS	
 To use your water heater as an emergency water supply, read the Warnings and Cautions noted on the back of this sheet, and then follow these step-by-step instructions. 	
TURN OFF THE WATER IN TWO LOCATIONS	
1	<p>Main Water Valve: Turn off the water at the main water supply to your home. This might be under the house, in the garage, on the outside of your house, or at the street. AND</p>  <p>Water Heater Water Valve: Turn off the water supply that goes directly into your water heater. This shut-off is at your water heater.</p> 
TURN OFF THE POWER OR GAS TO THE WATER HEATER.	
2	<p>Electric Water Heater: Turn off the power supply to the water heater at the main electrical panel.</p>  <p>Gas Water Heater: Turn off the gas supply to the water heater at the water heater itself.</p> 
RELIEVE PRESSURE IN YOUR WATER SYSTEM	
3	<p>Turn on a faucet somewhere in your home to relieve pressure in your system. Be prepared to collect any remaining water that might come out of that faucet.</p> 
ACCESS THE COLD-WATER INLET ON THE WATER HEATER	
4	<p>Use a wrench to remove the plumbing connection to the cold-water inlet (flexible supply tube) of the water heater. This will be on the top of the water heater, normally on the right side, and sometimes marked 'C' for cold. It may be blue. Some water may spill out when you remove it.</p> 
INSERT THE PLASTIC SIPHON TUBE INTO THE WATER HEATER	
5	<p>Push the clear plastic tubing down into the cold-water inlet (that you just opened) until it extends into the water. Some water heaters have an 'anti-thermosyphon' device blocking the opening. If so, carefully remove it with a screwdriver.</p> 
START THE SIPHON & FILL YOUR CONTAINER	
6	<p>There are a couple different methods to start the siphon process: the sucking method and the thumb method. <u>Sucking Method:</u> Gently suck on the end of the tube, holding the end of the tube lower than the water level in water heater. Remove your mouth and water should flow. <u>OR Thumb Method:</u> Hold your thumb over the end of the tube while you pull your end to a level below the water level inside the tank. Remove your thumb and water should flow.</p> 
2015 DIYBeReady ~Kutsch/Graves ~ Page 1 of 2	

E6. WATER HEATER SIPHON INSTRUCTIONS, CONTINUED

 WATER HEATER SIPHON WARNINGS & CAUTIONS 	
<p>Read these warning and caution notes below before deciding whether to use your water heater as an emergency water supply. Safety is always a priority.</p>	
<p>IS THE WATER SAFE TO DRINK?</p> <p>During a catastrophic disaster, such as a major earthquake, you may be able to use the water in your water heater for survival drinking water. While it is generally thought that the water inside a home water heater is safe to drink, err on the side of caution. If you have any doubt about it, be sure to purify the water before drinking it.</p>	
<p>WHAT ABOUT THE DRAIN ON THE BOTTOM OF THE WATER HEATER?</p> <p>While most water heaters have a drain, the drain on the bottom of the water heater should not be used, except as a last resort, for the following reasons:</p> <ul style="list-style-type: none"> • Sediment settles in the water heater tank. The drain is on the bottom and you may get sediment rich, perhaps muddy water from the tank. • Drains on water heaters are notoriously poor quality. You may not be able to turn it on, or worse yet, it may break while attempting to turn it off, in which case you will likely waste your precious water supply. • It can be difficult filling a container from the drain because it is so close to the floor or otherwise inaccessible. 	
	
<p>AFTER YOU ARE NOTIFIED THAT CLEAN WATER HAS BEEN RESTORED:</p> <ol style="list-style-type: none"> 1. REFILL THE TANK FIRST! Refill the water tank <i>before</i> having the gas or electricity turned back on. 2. GAS!!! If the gas is turned off, a professional MUST be the one to turn it back on. 3. DAMAGE!!! If the power is still on when the tank is empty, your tank will almost certainly sustain significant damage. 	
<p>2015 DIYBeReady ~ Kutsch/Graves ~ Page 2 of 2</p>	

BUDGETS & SUPPLY LISTS

F1. Basic Needs Budget for 300 People

F2. Berkeley Supply List & Budget

F3. Coastal Cache Inventory & Budget

F4. Coos Bay First Aid Cost Sheet

F5. Lincoln County Schools Supplies & Costs

F6. Tillamook Nest Kits Supply List & Costs

F7. Budget Worksheet

APPENDIX F: SAMPLE BUDGETS & SUPPLY LISTS

Overview: This section features examples of budgets and supply lists from five of the disaster cache projects in the Case Studies in Appendix B. Also included is a basic-needs cache budget for 300 people and a budget worksheet template.

F1. Basic Needs Budget for 300 People

This is an example of a community disaster cache with a \$10,000 budget to support basic survival needs such as shelter, water, and restrooms for 300 people.

F2. Berkeley Supply List & Budget

This spreadsheet shows the items, vendors, and prices of supplies and equipment that the City of Berkeley conveys to specific groups meeting requirements for their emergency supply program (Appendix B, Case Study B1).

F3. Coastal Cache Inventory & Costs

This spreadsheet depicts the Coastal Cache's disaster cache contents including item description, quantity, vendor, and costs. This is an example of a standalone disaster cache for a specific neighborhood (Appendix B, Case Study B2).

F4. Coos Bay First Aid Cost Sheet

The cost sheet provided represents the first aid portion of the City of Coos Bay's network of standalone disaster caches (Appendix B, Case Study B3).

F5. Lincoln County Schools Supplies & Costs

This disaster cache budget reflects the contents and costs of the school caches in Lincoln County are being developed over time through a collaboration with schools, cities and county, fire districts, and other partners. (Appendix B, Case Study B8).

F6. Tillamook County Nest Kits Supply List & Costs

This list represents the items and associated costs for the Tillamook County Neighborhood Emergency Supplies and Tools (NEST) Kits (Appendix B, Case Study B11).

F7. Budget Worksheet

This is a basic worksheet to assist teams with budget planning. It can be used as is or adapted to meet unique needs.

Note: The use of these examples does not indicate endorsement of products or vendors, and costs may not be accurate at the time of reading. We are simply providing examples of what others have done.

F1. BASIC NEEDS BUDGET FOR 300 PEOPLE

EXAMPLE BUDGET FOR BASIC NEEDS CACHE SUPPORTING 300 PEOPLE					
ITEM	DESCRIPTION	QTY	PRICE	TOTAL	NOTES
CACHE STORAGE BUILDING					
Steel Shipping Container	20' x 8' new	1	\$3,700.00	\$3,700.00	Includes delivery
Ground Prep & Locks	8x8 wood, Gravel, Padlock	1	\$300.00	\$300.00	Labor donated
2" Foam Board Insulation	4ft x 8ft sheets	19	\$40.00	\$760.00	Labor donated
Liquid Nails		1	\$37.00	\$37.00	For Insulation
SHELTER					
Tarps	10' x 20' Heavy Duty	300	\$10.00	\$3,000.00	1 Tarp per person
Rope	25' Poly	300	\$1.00	\$300.00	25' per person
Mylar Blankets	52" x 84"	300	\$0.40	\$120.00	1 per person
WATER					
55-gallon Barrels	Includes purifier, pump, & wrench	12	\$120.00	\$1,440.00	2.2 gal per person (4 days @ ½-gal per day)
Plastic Disposable Cups	12 ounce, 240cups	3	\$20.00	\$ 60.00	2 cups per person
RESTROOMS					
Toilet Buckets	5-gallon bucket with toilet seat lid	8	\$18.00	\$144.00	2 buckets per tent (1- each POO & PEE)
Pop-up Privacy Tents		4	\$30.00	\$120.00	75 people per bathroom
Sand Buckets & hand shovels	2 or 3-gallon buckets	8	\$ 1.00	\$8.00	Material to cover poop
Compostable Trash Bags	100 count	1	\$ 11.00	\$11.00	Toilet Liners
TOTAL				\$10,000.00	

F2. BERKELEY SUPPLY LIST & BUDGET

Items	# Per Cache	Vendor	Part Number	Price Per Item
Loose Items				
Small Shed		Grainger	32XT03	\$ 390.66
Large Shed		Grainger	32XT04	\$ 705.35
Storage Containers	-4	Grainger	3CLV2	\$ 45.54
Water Tank Kit	-2	Nexis	WB-255	\$ 126.00
Medical Kit	-1	Nexis	FA-901	\$ 251.37
Generator	-1	Grainger	53EC14	\$ 747.57
Propane Tank	-2	Grainger Special Order	?	\$ 96.22
10 x 10 Canopy	-1	Grainger	5NY99	\$ 365.50
LED Tripod Light	-1	Grainger	422V07	\$ 165.44
36" Axe	-2	Grainger	20C890	\$ 29.10
Pry Bar 60"	-2	Grainger	11Z397	\$ 68.50
Box 1 PPE				
Hard Hats	-6	Grainger	24M953	\$ 6.30
S Work Gloves	-3	Grainger	5AJ40	\$ 3.46
M Work Gloves	-3	Grainger		\$ 3.46
L Work Gloves	-3	Grainger	6AJ36	\$ 3.46
XL Work Gloves	-3	Grainger	5AJ37	\$ 2.68
N95 Masks	-2	Grainger	3KP43	\$ 20.90
Protective Glasses	-6	Grainger	34WR27	\$ 1.29
Box 2 Fire Suppression				
ABC Fire Extinguisher	-2	BEST Extinguisher's	Amerex B500	\$ 48.00
Backpack Pump	-2	LN Curtis	179061V INDIAN	\$ 134.00
50ft 3/4" Fire Hose	-4	LN Curtis	2F06X50W07GHB AAH	\$ 38.00
Double Male Hose Fitting	-2	Grainger	4KG82	\$ 4.85
Double Female Hose Fitting	-2	Grainger	1P724	\$ 4.85
Hose Nozzles	-4	Grainger	2LPN3	\$ 41.96
Box 3 Electrical				
50' Extension Cord	-4	Grainger	3EB10	\$ 65.50
Power strip	-2	Grainger	52NY43	\$ 12.38
LED Portable Light	-2	Grainger	422V12	\$ 61.60
Flashlights	-4	Grainger	32ZN12	\$ 4.70
D Batteries for Flashlights	-1	Grainger	22M704	\$ 17.70
Portable Radios	-2	Grainger	49EG66	\$ 55.78
AM/FM Solar Radio	-1	Nexus Prep	EM-311	\$ 56.68
Box 4 Misc.				
Water Barrel Pump	-2	Nexis Prep	kit	kit
Water Barrel Wrench	-2	Nexis Prep	kit	kit
Water Treatment	-2	Nexis Prep	kit	kit
Collapsible Yellow Pails (3 gallon)	-2	LN Curtis	83224 PECO	\$ 12.75
3" X 1000' Rolls Caution Tape	-4	Grainger	21YH35	\$ 26.00
Duct Tape	-4	Grainger	6JD46	\$ 7.50
Hammer	-2	Grainger	6DWJ2	\$ 26.64
Padlock	-1	Grainger	5JKW8	\$ 28.90

F3. COASTAL CACHE INVENTORY & COSTS

Item	Description	Vendor	# of Units	Cost per Unit	Total Costs
SHELTER					
Wenzel multi-person tents	10 x 18	Amazon.com	4	\$199.96	\$799.84
Coleman multi-person tents	10 x 17	Amazon.com	2	\$139.99	\$279.98
Wall-tent/open floor	10 x 20	Fred Meyers	1	\$199.00	\$199.00
Medical tent/open floor	10 x 20	Fred Meyers	1	\$200.00	\$200.00
Canopy tent/emerg ops ctr	10 x 10	Unknown-donated	1	\$100.00	\$100.00
Tarps	10 x 18	Amazon.com	10	\$9.99	\$99.90
Stakes	40 heavy duty 4/tarp	Amazon.com	10	\$2.99	\$29.90
Large nails	8" & 12" add'l stakes	Ace Hardware	1	\$14.16	\$14.16
Rubber mallet	For stakes	Ace Hardware	1	\$5.99	\$5.99
Rope (for tie downs)	Nylon 3/8" 600 ft total	Englund Marine Npt.	600	\$0.14	\$84.00
Zip ties (for tarps)	Rugged 10", bag of 100	Amazon.com	2	\$7.49	\$14.98
Waterproof seal	For tent	Fred Meyers & Ace	6	\$7.99	\$47.94
Mylar blankets		Amazon.com	250	\$0.76	\$189.44
WATER					
Water barrels	Used 55-gallon	Barrelhead Supply	15	\$15.59	\$233.85
Community LifeStraw	Back-up water filter	Moreprepared.com	1	\$363.18	\$363.18
Filtr System W/5-gal bucket	Back-up water filter	Unknown-Donated	1	\$50.00	\$50.00
Water siphon pump	Manual	Globalindustries.com	3	\$36.70	\$110.11
Barrel opener bung wrench	Aluminum non-sparking	Amazon.com	3	\$11.81	\$35.44
Preservative/ bleach	Water purifier/gallons	Safeway	1	\$1.99	\$1.99
Measuring cup	¼ cup for bleach	Cash & Carry, Npt	1	\$3.29	\$3.29
Funnel	Large	Ace Hardware	1	\$2.79	\$2.79
Siphon	For home water heater	Unknown-donated	1	\$10.00	\$10.00
Solo cups	400 total, bags of 50	Cash & Carry, Npt	8	\$4.09	\$32.72
Jugs, gallon	For water distribution	Fred Meyers	4	\$0.89	\$2.56
MEDICAL					
Stretchers flexible	10 handle, quick deploy	BuyEMP.com	4	\$14.35	\$57.40
Stretchers	Plywood (2-6ft, 2-8ft)	Ace Hardware	4	\$12.25	\$48.98
Body bags		BodyBagStore.com	10	\$8.95	\$89.54
Medical gloves m, lg, xlg	Non-sterile	Pacific Medical Supply	200	\$0.11	\$21.00
ABD pads	Large pads	Pacific Medical Supply	180	\$0.50	\$90.00
Gauze bandages	2 x 2 and 4 x4	Pacific Medical Supply	440	\$0.05	\$22.00
Gauze bandage rolls		Pacific Medical Supply	192	\$0.75	\$144.00
Medical tape	Various sizes	Pacific Medical Supply	36	\$1.75	\$63.00
Betadine	Antiseptic 16oz container	Amazon.com	32	\$11.54	\$369.28
Rubbing alcohol	Disinfectant, qt containers	Fred Meyers	16	\$1.99	\$31.84
Cotton balls	200 medium	Fred Meyers	2	\$3.49	\$6.98
Cotton balls	500 small	Amazon.com	1	\$5.70	\$5.70
Medical cups	1 oz size, 100	Amazon.com	5	\$4.74	\$23.70
Sheet bandages	Strips in buckets	Unknown/donated	2		0
Sheets	Boxes of clean sheets	Unknown/donated	2		0
First aid book					

F3. COASTAL CACHE INVENTORY & COSTS, CONTINUED

Item	Description	Vendor	# of Units	Cost / Unit	Total Cost
Tongue depressors	For splints, box of 75	Jo-Ann Fabrics	1	\$1.74	\$1.74
SAM splints	36" x 4.25" packs of two	Rescue-essentials.com	5	\$21.95	\$109.75
SANITATION					
Rain proof shelter	Tents for commodes	Moreprepared.com	3	\$67.40	\$202.19
Metal stub up pipe	For waste	Groth-Gates Heating	3	\$11.00	\$33.00
"L" brackets & hardware	Attach toilet to plywood	Ace Hardware	1	\$50.57	\$50.57
Plywood	Potty base 8' x 4'	Ace Hardware	3	\$33.97	\$101.91
Furring	Stabilize plywood platforms	Ace Hardware			\$9.57
Commode	Toilet and seat	HealthyKin.com	3	\$17.77	\$53.30
Toilet paper	240 rolls/ case of 20	Cash & Carry, Npt	12	\$12.79	\$153.48
Gallon ziplocks	Boxes of 30	Safeway	3	\$3.99	\$11.97
Scoops	For waste coverage	Safeway	3	\$1.99	\$5.97
OFFICE					
Pencils	And sharpener	Ace Hardware	1	\$2.98	\$2.98
All weather notebooks	Rainproof	Ace Hardware	1	\$9.99	\$9.99
Notebooks		Fred Meyers	3	\$2.15	\$6.46
Scissors		Unknown/Donated	4	\$10.00	\$40.00
Clipboards		Unknown/Donated	4	\$10.00	\$40.00
Lumber Crayons	House markers/bx of 12	Ace Hardware	12	\$0.99	\$11.88
TOOLS					
Sledge hammer/wood maul		Ace Hardware	1	\$25.99	\$25.99
Pike Pole		Englund Marine, Npt	1	\$50.75	\$50.75
Crow bars		Fred Meyers	2	\$16.99	\$33.98
Pry bars	15"	Ace Hardware	1	\$8.99	\$8.99
Prybar/ hatchet/ hammer	Combination tool	Amazon.com	2	\$11.48	\$22.96
Bolt cutters	24"	Ace Hardware	1	\$24.99	\$24.99
Pipe cutter	Hacksaw	Ace Hardware	1	\$5.49	\$5.49
Shovels	Long handle, spade type	Ace Hardware	4	\$8.99	\$35.96
Phillips head screwdrivers	Various sizes	Ace Hardware	2	\$4.49	\$8.98
Flat head screwdrivers	Various sizes	Ace Hardware	2	\$0.75	\$1.50
All purpose grabber		Englund Marine, Npt	1	\$22.00	\$22.00
Box cutters		Unknown/Donated	3	\$1.00	\$3.00
PERSONAL PROTECTION					
Rain suits	Pants, jacket w/hood	Big Five Newport	36	\$7.99	\$287.64
Dust masks	Case of 1000	Ace Hardware	1000	\$0.23	\$233.60
Leather gloves	All purpose work gloves	Tuffmate.com	144	\$3.65	\$525.25
ELECTRONICS					
Lantern/flashlights	Hand crank, LED	Amazon.com	3	\$29.99	\$89.97
NOAA Radios	Hand crank	Amazon.com	2	\$39.99	\$79.98
Flashlights	Hand crank	Amazon.com	2	\$14.99	\$29.98
GENERAL PURPOSE					
Fire Extinguisher		Ace Hardware	1	\$9.99	\$9.99
Flare gun		Englund Marine, Npt	1	\$65.50	\$65.50
Flares		Ace Hardware	6	\$2.50	\$14.98
Orange fluorescent paint	For heli pad landing	Ace Hardware	2	\$5.99	\$11.98
Caution Tape	Roll 50'	Ace Hardware	1	\$11.99	\$11.99

F3. COASTAL CACHE INVENTORY & COSTS, CONTINUED

Item	Description	Vendor	# of Units	Cost per Unit	Total Costs
Orange fencing	50'	Ace Hardware	1	\$24.99	\$24.99
Plastic garbage bags	Trash bags	Ace Hardware	150	\$0.31	\$45.94
Roll black plastic sheeting		Fred Meyers	1	\$19.99	\$19.99
Lighters	Bio-type disposable	Ace Hardware	12	\$0.99	\$11.88
Waterproof matches	4-pack	Ace Hardware	2	\$2.29	\$4.58
Total					\$6,442.07

F4. COOS BAY FIRST AID KIT COST SHEET

Item	Quantity	Cost Each	Total Cost
Bandaging			
8x10 Combine Pad	20	\$ 0.23	\$ 4.60
4x4 Sponges	250	\$ 4.35	\$ 21.75
2x2 Sponges	200	\$ 1.92	\$ 7.68
Band-Aids	100	\$ 1.40	\$ 2.80
Coban	28	\$ 1.78	\$ 49.84
3" Stretch Gauze	16	\$ 4.68	\$ 9.36
1" Medical Tape	12	\$ 12.96	\$ 12.96
Splinting			
Triangle Bandages	6	\$ 0.35	\$ 2.10
SAM Splint	5	\$ 9.11	\$ 45.55
C-Collar	4	\$ 4.10	\$ 16.40
Wound Prep			
Isopropyl Alcohol	2	\$ 2.00	\$ 4.00
Burn Dressing	9	\$ 65.25	\$ 65.25
Alcohol Preps	200	\$ 4.32	\$ 4.32
Diagnostics			
BP Cuff	2	\$ 6.95	\$ 13.90
Stethoscope	2	\$ 9.10	\$ 18.20
SaO2 Monitor	2	\$ 52.96	\$ 105.92
Pupil Gauge	6	\$ 5.16	\$ 5.16
Miscellaneous			
Trauma Shears	2	\$ 1.72	\$ 3.44
Bio-Hazard Bags	4 Rolls		\$ 20.00
Large Gloves	2 Boxes	\$ 6.50	\$ 13.00
Medium Gloves	2 Boxes	\$ 6.50	\$ 13.00
27 Gallon Tote	1		
Total Cost			\$ 439.23

F5. LINCOLN COUNTY SCHOOLS SUPPLIES & COSTS

This is the general budget for a basic-needs disaster cache serving 500 students and staff, housed in one 20-foot shipping container. The budget reflects pricing as of May 2021. They hope to be able to salvage food and other supplies from the school buildings.

LCS D ITEM	DESCRIPTION	QTY	PRICE	TOTAL	NOTES/VENDOR
CACHE BUILDING					
Steel Shipping Container	20' new, includes delivery	1	\$4,910.00	\$4,910.00	Riverside Containers
Ground Prep & Locks	8x8s, gravel, lock, keys	1	\$400.00	\$400.00	Labor donated
Storage Totes w/lids	Small & Medium	45	\$6.00	\$270.00	Costco, BiMart, Walmart
Industrial Shelves	77x72x24	2	\$170.00	\$340.00	Costco
SHELTER & WARMTH					
Rain Ponchos	1 per person	500	\$.75	\$375.00	Dollar Tree or Amazon
Tents for Shelter	10'x20' Steel Frame	14	\$230.00	\$3220.00	Costco
Pop-up Canopies	For operations & staging	10	\$75.00	\$750.00	Bi-Mart
Stakes	Heavy duty	300	\$1.00	\$300.00	12 per tent, ACE
Mallets	For tent stakes	2	\$1.00	\$2.00	Dollar Tree
Sandbags	100 per package, 14x26"	4	\$30.00	\$120.00	12 per tent, Amazon
Pointed Shovels	For filling sandbags	2	\$25.00	\$50.00	ACE
Tarps	10' x 20', Heavy Duty	32	\$10.00	\$320.00	For open-floor tents, ACE
Rope	1000' spool, 3/8" poly	8	\$78.00	\$624.00	125' per tent, ACE
LED/Solar Lanterns	1 per tent, canopy, &RR	32	\$10.00	\$320.00	LC Sporting Goods
Mylar Blankets	52" x 84", 1 per person	500	\$0.50	\$250.00	Amazon
Stocking Caps	1 per person	500	\$1.00	\$500.00	Many have been donated
WATER					
55-gallon Barrels	+ purifier, pump, wrench	12	\$110.00	\$1320.00	2 days, 1/2+ gal/person
12oz Disposable Cups	Sturdy, 240 cups/box	6	\$20.00	\$120.00	
Water Filter Straws	Frontier 20-30 gallons	500	\$6.00	\$3000.00	LC Sporting Goods
Water Filter System	LifeStraw Community	2	\$400.00	\$800.00	LifeStraw
SANITATION					
Toilet 5-gal Buckets	2 toilets per pop-up tent	16	0	0	Salvage from classrooms
Pop-up Privacy Tents	Restrooms	8	\$30.00	\$240.00	Amazon
Sm Buckets & Shovels	1 each per restroom	8	\$1.00	8.00	Dollar Tree
Toilet Liners	Plastic garbage bags		0	0	Salvage from schools
MEDICAL					
PPE Kit	Masks, gloves, goggles	1	\$200.00	\$200.00	
Disaster Medical Kit	Bandages, gauze & tape	1	\$200.00	\$200.00	Basic Kit
Mylar Blankets		50	\$0.50	\$25.00	Amazon
Cots		4	0	0	Donated, Red Cross
MISC					
Search & Rescue Kit	4-person kit, PPE & Tools	1	\$500.00	\$500.00	Mayday Industries
Plastic Sheeting	Husky 10'x100'	6	\$40.00	\$240.00	For broken windows
Flat Shovels	For broken glass/ debris	4	\$20.00	\$80.00	ACE
Staple gun & Staples	Use with plastic sheeting	4	\$30.00	\$120.00	To cover windows
Construction Bags	2'x4', 20 per box	10	\$15.00	\$150.00	For cleanup, ACE
TOTAL				\$19,754	

F6. TILLAMOOK COUNTY NEST KITS SUPPLY LIST & COSTS

EVCNB NEST Box Kit Item	Vendor	# of units	Per unit	Total for 1 kit
Solar power charger	Amazon	1	61.99	\$ 61.99
Manual crank 5V charger/radio	Amazon	1	14.97	\$ 14.97
Flashlights, battery	Home Depot	4	2.74	\$ 10.96
Flashlights, pump LED	Fire Supply Depot	4	4.00	\$ 16.00
Headlamps, battery	Home Depot	2	13.98	\$ 27.96
Headlamps, dynamo LED	Fire Supply Depot	2	10.00	\$ 20.00
LED lanterns: UST 30 day Duro	Amazon	1	26.07	\$ 26.07
LED lanterns: Mpowerd 2.0	Amazon	2	18.31	\$ 36.62
Low fuel stove	Biolite	1	151.15	\$ 151.15
Fire starters	Ace Hardware	1	18.13	\$ 18.13
Dust masks N95s(3M #9010)	Amazon	1	13.13	\$ 13.13
Silca gel packs	Amazon	1	9.99	\$ 9.99
10' x 20' blue general use tarp	Hal's	4	12.55	\$ 50.21
10' x 20' blue general use tarp	Home Depot	2	28.50	\$ 57.00
10' x 10' blue general use tarp	Hal's	4	6.00	\$ 24.00
Red, yellow, green, black duct	Home Depot	2 ea for 5 kits		\$ 16.88
Mylar blankets	Fire Supply Depot	25	1.34	\$ 33.50
Ponchos	Amazon	20	1.39	\$ 27.70
Rope nylon 3/8" by 50'	Hal's	4	4.00	\$ 16.00
Rope diamond braid 1/4" x 100'	Home Depot	1	7.96	\$ 7.96
Foam hand soap	Amazon	1	21.28	\$ 21.28
Shop towels	Home Depot	50	24.83	\$ 24.83
Wag bags (100)	Amazon	2 of 50	107.99	\$ 216.00
Purell disinfectant gel	Amazon	1	42.77	\$ 42.77
Disinfect. wipes (hands) 6 pk	Amazon	1	15.88	\$ 15.88
Disinfect. wipes (surface) 5pk	Costco	1	12.00	\$ 12.00
Pop up Privacy Pod	Walmart	1	25.00	\$ 25.00
Toilet paper	Costco	12 rolls		\$ 7.00
First Aid Kit for 100 people	Amazon	1	34.99	\$ 34.99
Gauze pads (2 x 2)	Amazon	1 /100	6.00	\$ 6.00
Nitral latex-free gloves (100)	Costco	2 boxes	12.00	\$ 24.00
OTC pain relievers (4 types)	Costco	1 each	35.84	\$ 35.84
Water resistant notebooks	Home Depot	3	7.90	\$ 23.70
Write-anywhere pen	Office Depot	3	13.00	\$ 39.00
Laminating pouches	Office Depot	20	7.00	\$ 7.00

F6. TILLAMOOK COUNTY NEST KITS SUPPLY LIST & COSTS, CONTINUED

EVCNB NEST Box Kit Item	Vendor	# of units	Per unit	Total for 1 kit
Clipboards, paper, pens, markers, masking tape	Office Depot	3 sets	8.00	\$ 25.40
Weather tight plastic bins, med	Walmart	4	11.50	\$ 46.00
Weather tight plastic bins, lg	Walmart	2	16.50	\$ 32.56
Gray duct tape	Home Depot	1	9.56	\$ 9.56
Rope nylon 3/8" by 50'	Home Depot	2	5.87	\$ 11.74
Measuring spoons	Hal's	1	2.00	\$ 2.00
Water transport containers	EVC	4	0.00	\$ -
Hand wash station (WaSH)	EVCNB	1	6.00	\$ 6.00
5 gal food grade buckets	EVCNB	6	0.00	\$ -
Water filter	JustWater	1	27.00	\$ 27.00
5 gal non-food grade buckets	Home Depot	2	3.42	\$ 6.84
Measuring pail (2 1/2 qt)	Home Depot	1	2.38	\$ 2.38
Easy off lids for 5 gal buckets	Home Depot	12	1.88	\$ 22.56
Coleman 12 in 1 scissors	Amazon	2	6.99	\$ 13.98
Tent stakes for privacy pod	Amazon	4	0.49	\$ 1.96
Pool Shock (pounds)	Amazon	2	3.06	\$ 6.12
Waterworks Test strips	Amazon	1	13.64	\$ 13.64
Drive Medical Folding Commode	Amazon	1	36.74	\$ 36.74
Incident command vests	eSafetySupplies	5	10.45	\$ 52.25
Sheet protectors, plastic envelopes	Office Depot		7.40	\$ 7.40
Gauze pads (4 x 4)	Amazon	1	11.49	\$ 11.49
Pens	Amazon	2	10.91	\$ 21.82
Clipboards	Amazon	2	3.00	\$ 6.00
YR desktop charger	Amazon	1	7.27	\$ 7.27
Barrel-to-USB cable	Amazon	1	12.25	\$ 12.25
Emergency whistles	Amazon	2	3.90	\$ 7.80
Notebooks	Amazon	2	4.33	\$ 8.66
Zip lock jumbo bags	Amazon	1	2.68	\$ 2.68
Sharpies	Amazon	2	0.83	\$ 1.66
Kerlix bandage wrap	Amazon	9	1.22	\$ 10.98
Writing pads, pens, color prints	Staples	set	4.92	\$ 4.92
Butane lighters	Hal's	1	1.69	\$ 1.69
Waterproof matches	Amazon	1	2.71	\$ 2.71
TOTAL COST				\$ 1,599.57

F7. BUDGET WORKSHEET

BUDGET WORKSHEET					
ITEM	DESCRIPTION	QTY	UNIT PRICE	TOTAL	VENDOR/NOTES
CACHE STORAGE BUILDING					
WATER					
SHELTER & WARMTH					
FOOD					
SANITATION					
MEDICAL					
SEARCH & RESCUE					
MISC					

OPERATIONS PLANS

G1. Coastal Cache Jobs List & Survivor Registration Form

G2. Lincoln County Schools Instructions

G3. Safe Haven Hill Emergency Command Procedures & Task Protocols

G4. Tillamook County Task Cards

G5. Decision-Tree for Opening a Cache

G6. Task Card Template

APPENDIX G: OPERATIONS PLANS

Overview: This section features a variety of operations plans from four unique disaster cache projects. Each provides instructions in different formats such as task cards, protocols, job lists, or just basic instructions. Also included are an example of a decision-tree flowchart to help determine when to open a disaster cache and a task card template.

All of these examples can be used “as is,” adapted to meet unique cache missions, or simply used to inspire other cache operational guidelines.

G1. The Coastal Cache features an “Open First” letter, a jobs list, and a Survivor Registration Form (Appendix B, Case Study B2).

G2. The Lincoln County Schools Cache Instructions include a “Read This First” directive that identifies priorities. It follows with instructions to correspond with each priority. (Appendix B, Case Study B8).

G3. The Safe Haven Hill Emergency Command Procedures & Task Protocols provides emergency

command procedures and individual task protocols (Appendix B, Case Study B9).

G4. The Tillamook County Task Cards provide step-by-step instructions that correspond with each component of their Nest Kits (Appendix B, Case Study B11).

G5. The Example Decision-Tree for Opening a Cache is a model that can be emulated to provide clear guidance for when a cache should and should not be deployed.

G6. The Task Card Template can be used or modified to assist a planning team with articulating instructions for various tasks related to the supplies in the disaster cache.

G1. COASTAL CACHE INSTRUCTIONS & JOBS LIST

OPEN FIRST

Dear Friends and Neighbors,

If you are reading this, some emergency event has probably occurred to send you to the Cache. Remember, if there has been an earthquake, it is recommended that you stay out of your homes for approximately three days or until the aftershocks have stopped. If there has been an earthquake, there may also be a local tsunami. Even with a distant tsunami, it is recommended that you stay away from your homes until at least twelve hours have passed. More waves may come, even many hours later. Please see the Emergency Preparedness pamphlets under the "INFORMATION" tab for more advice and instruction.

A list of tools and supplies that are included in this container can be found under the "INVENTORY" tab. In addition to the stored tools and supplies, many neighborhood residents have completed an emergency preparedness questionnaire and that database information has been included under the tab "E(MERGENCY) P(REPAREDNESS) DATA BASE." Items and tools that are available for community use in an emergency, and other information regarding the status and skills of the people in the community can be found under the "E P DATABASE" tab.

All of the medical supplies are grouped together in the nets that are strung from the walls of the cache. In addition to the supplies, there are 4 plywood stretchers located under the nets. There are 4 flexible stretchers and 10 body bags if needed. A complete list of the supplies can be found under the "INVENTORY" tab.

For shelter, there are 3 open floor wall-tents to be used for an operations center, hospital, and gathering place by day/sleep by night. In addition, there are 6 ten-person, three-room, camping tents. They are to be used by people who are unable to sleep in their cars or in a safe house. There are 250 waterproof Mylar blankets to be used for warmth. A complete list of supplies available can be found under the "INVENTORY" tab.

There are 14 fifty-five-gallon barrels of water and back-up systems for you to use until you can get back into your homes and siphon off the water that is in your water heaters. Remember to turn your home water valves off to protect the water in your heaters from contamination in the line. Please see the "WATER" tab for more information including the "Attaching the Water Pump" instructions.

Information for latrine placement, trench excavation, and commode assembly for two complete commodes can be found under the "SANITATION" tab.

A map of our neighborhood is included under the "MAP" tab.

In 2015, this cache was supplied and stocked in order to prepare and provide for you and your needs. The information contained in this binder will help you with your immediate needs and provide guidance for future jobs to be completed under the "JOBS LIST" tab.

- INVENTORY (CACHE CONTENTS)
- WATER (INFORMATION AND INSTRUCTIONS FOR ATTACHING THE WATER PUMP)
- SANITATION (INFORMATION AND INSTRUCTIONS FOR TRENCH PLACEMENT, EXCAVATION, AND COMMODOE ASSEMBLY)
- JOBS LISTS (SUGGESTED)
- EMERGENCY PREPAREDNESS DATABASE (RESIDENT QUESTIONNAIRE RESULTS AND FIRST RESPONDER INFORMATION SHEETS)
- INFORMATION (TSUNAMI, EARTHQUAKE, AND GAS SHUT-OFF PAMPHLETS)
- MAP OF NEIGHBORHOOD

G1. COASTAL CACHE JOBS LIST, CONTINUED**JOBS LIST**

Some of these jobs can be completed, but many jobs will be ongoing. The urgency and difficulties of the situation will determine the order of completion. Many jobs can be done simultaneously. The first thing to do will be to identify a leader and/or a few co-leaders, ideally using our community CERT members as a resource. The leaders will assign crews to help with each one of these suggested tasks. There are gloves, dust masks, and rain suits to protect the crewmembers. If there is a need for more rain protection, there are garbage bags that could be used as ponchos. There are many different tools to help crewmembers also. Please see the "INVENTORY" tab Tools section for the complete list.

SHELTERS CREW: Find a safe area near the cache that is free from falling trees. Clear an area if you have to. There is a pike pole and some caution tape if your area needs to be cleared of, or roped off from something dangerous. There are chain saws stored in the clubhouse shed as well.

There are 3 open floor wall-tents in this cache. One of them is 10' x 10', and two of them are 10' x 20': one is to be used as a hospital tent, one is to be used as an emergency operations tent, and one is to be used as a gathering tent. They can all double as sleeping tents at night as needed. The wall-tents are going to need capable people to erect. The use of a ladder or a pick-up truck as a platform will be needed to provide help with the set-up. The two 10' x 20' tents are the same type, but one is still in the original box and one has its parts labeled and stored in the plastic bins and against the wall next to the stack of tents.

Also, included in this cache are 6 multi-person, three-room camping tents that can house people as well. If there is a need, house more than the suggested number of people in each one of these tents. Where you place these tents will probably be determined by the clear spaces you are able to find, but keep them relatively close to the latrine area. They are freestanding tents, but if used this way, they need to be weighed down with people's possessions for stability.

Tools available include a mallet, 40 extra stakes, 10 blue tarps, and some 12" and 8" nails. There are 6 spray cans of waterproofing available also.

HOSPITAL WORKERS: There is a complete list of the available supplies under the "INVENTORY" tab Medical Supplies. Set up several sub crews to help. Doctors and nurses, if any, and first aid workers need to be identified. Set up the hospital and organize the supplies. There are two boxes of sheets for use also.

FIRE TENDERS: Choose an appropriate clear and safe area to keep a fire going. There are tools for this purpose: a splitting maul, two hatchets, waterproof matches, and lighters. This will become the kitchen area also when the Kitchen Crews supply whatever food they find. Makeshift tables and food preparation areas need to be assembled.

G1. COASTAL CACHE JOBS LIST, CONTINUED

MESSENGERS: It will be necessary to have messengers who can communicate with the various crews in the event there is no cellphone service and/or electrical power available. There are notebooks and pencils if needed.

WATER MANAGERS: There are 14 fifty-five-gallon barrels of water. One gallon/per person/per day. There is a sign to serve as a reminder. "Community Water is for Drinking Only"

Rainwater, using tarps or any available and appropriate objects, should be collected at every opportunity for drinking. Fresh water **MUST** be reserved for drinking (and cooking where appropriate). Washing of hands, bodies, clothing etc. can be done with safe-for-use ocean (salt) water.

There is a **water pump** that needs to be assembled. Please see the "Attaching the Water Pump" instructions under the "WATER" tab. There is also a back-up pump. There are three **back-up systems** for you to use also. These systems need to be set up as soon as possible.

A) When it is safe to get back into your homes, siphon off the water that is in your water heaters. Remember to turn your home water valves off to protect the water in your heaters from contamination in the line.

B) There is a LifeStraw Community Water Filter straw (see p. 18-20).

C) There is a portable filtration system with a five-gallon bucket (instructions are in the bucket).

The crew members need to begin collecting all available water as soon as possible, including using the siphon hose to collect water heater water as soon as it is safe to enter houses.

MEDICAL SEARCH CREWS: The situation you find yourselves in will determine your course of action. The decisions and responses will depend upon the severity of the conditions that exist. Divide the crews into sub crews as needed.

- To transport the wounded, there are 2 six-man plywood stretchers and 2 eight-man plywood stretchers. In addition, there are 4 flexible stretchers that can be used also.
- There are 10 body bags to be used and if needed, some construction size garbage bags as well.
- There is a roll of caution tape.

There are lumber crayons to write on the outside of homes to indicate the medical status of the occupants and condition of the house.

FEMA and the Certified Response crews are taught a universal marking system. It consists of a large **X** written on the most visible **front side of a house**. Do not use the door of a house in case the door opens and hides the mark. Do not use windows. Use lumber crayons as follows: When a crew enters a home, it places a line \ on the side of the home and when the crew leaves the home, it places the other half of the ex on the door /.

- In the upper quadrant, record the date and time of leaving the building.
- In the lower quadrant, record the condition of the occupants. E. g. 4-alive, 1-dead.
- In the left quadrant, record the id name, and number of the search team.
- In the right quadrant, record anything that might be a hazard. E. g. broken gas line, rats.
-

G1. COASTAL CACHE JOBS LIST, CONTINUED

LATRINE CREW: There are 4 long-handled shovels and it is recommended that you dig latrine trenches in a not too far away open space. The backyard of the Clubhouse would be an ideal spot if possible. Dig the trenches running East to West so that the prevailing winds minimize the odor. Please see an "Aerial Photo for Latrine Trench," which is included as a guideline. Dig the first trench at the end farthest from the clubhouse so that as it fills, the next trench can be dug parallel and in front of the first trench and so on. Also included is a "Latrine Trench Design," which shows the recommended size of the trench to be dug, and the recommended placement of the Commodes.

COMMODOES ASSEMBLERS: Please refer to the "Assembling the Commode" for a diagram. There are two plywood platforms labeled "A" and "B", two metal waste pipes labeled "A" and "B", two portable commodes, and two shelter/cabana tents that are to be used as temporary bathrooms.

1. Place the plywood platforms across the trenches with the hardware up.
2. There are two metal waste pipes to be attached to the plywood platforms to channel the waste into the trenches. Attach the "A" metal waste pipe to the "A" plywood platform. Attach the "B" metal waste pipe to the "B" plywood platform. There are predrilled holes in the plywood platforms in order to attach the L brackets on the metal waste pipes to the plywood platforms. There are Phillips head screwdrivers in the tool boxes, and there are screws provided for attaching the metal waste pipes to the plywood platforms. The screws are in Ziploc bags that are taped to the metal waste pipes.
3. Set up the shelter/cabana tents and attach them to the plywood platform. When the shelter/cabana tents are assembled, the O rings at the four corners of the tents need to be secured to the S hooks that are attached to the plywood platforms. In addition to the O rings, the tents need to be tied down with the guy wires. These are situated at the back of the tents (in the center) and at the two sides of the tents (in the center).
4. Set the commode in the shelter/cabana tents. Set the open-bottomed gray bucket into the frame of the commode and set both over the waste pipe, so that the bucket rests in the frame of the commode and in the metal waste pipe. Secure the bucket to the frame of the commode with duct tape.
5. There is spray waterproofing to protect the seams of the shelter. There are tarps available for additional shelter protection if needed.
6. There is toilet paper to be brought over to the outhouses as needed, or to be otherwise distributed.
7. For health and sanitary reasons, it is recommended that the waste be covered as much as possible. Fill up 2 three-gallon buckets with the sandy soil from the trench excavation and place one of the buckets inside each shelter along with the sand shovels for use as needed.

G1. COASTAL CACHE JOBS LIST, CONTINUED

RECORDERS: Recorders need to interview each person and secure the information for the first responders to inform the outside world. Forms for this purpose are included in the "E P DATABASE" tab. It includes name, address, phone # and e-mail address, the subject's condition (any injuries or not), the name of next of kin, and any known next of kin contact information e.g. phone #, e-mail address, and/or mailing address. Some of this information will already be available in the Emergency Preparedness Data Base that is also included under the "E P DATABASE" tab.

Tools available include a waterproof notebook, three notebooks, four clipboards, a box of pencils, and a sharpener. There are scissors and lumber crayons (for marking on homes) available also.

KITCHEN CREW: The container of dried food in the cache will provide approximately 330 meals. People will retrieve and cook the available food that will need to be salvaged from the homes that are still standing. Fresh food, and the contents of the refrigerators and freezers, is to be used first. The Kitchen Crews need to search for larger pots and cooking vessels for use back at the site. Set up sub crews including Chefs and Food Preparers, Retrievers, and Pantry Managers.

SUPPLIES CREW: This crew needs to be separate from the Kitchen Crew and will be responsible for the house-to-house search for tools and/or supplies that need to be used by the community. In 2015 when this cache was set up, many homeowners filled out an Emergency Preparedness Questionnaire indicating what unique tools they owned that would be available for use. The information from these questionnaires is available under the "E P DATA BASE" tab. Supplies Crew can rely on the included forms as a starting point.

SECURITY: There will be a need for security crews to walk the perimeter of the area to provide security from any unwanted activity. How many crews and how they manage this operation will be based on the situation that exists.

Strangers, however, should not be turned away if they need shelter, water, or medical attention. Just as we would hope to be welcomed if we found ourselves away from home, let us share our supplies wherever possible.

G1. COASTAL CACHE SURVIVOR REGISTRATION FORM, CONTINUED

SURVIVOR REGISTRATION FORM		
NAME and AGE:	ANY INJURIES (describe):	EMERGENCY CONTACT NAME:
ADDRESS:	LOCATION OF INJURY:	ADDRESS:
PHONE #:	SEVERITY OF INJURY:	PHONE #:
Email ADDRESS:		Email ADDRESS:
SURVIVOR REGISTRATION FORM		
NAME and AGE:	ANY INJURIES (describe):	EMERGENCY CONTACT NAME:
ADDRESS:	LOCATION OF INJURY:	ADDRESS:
PHONE #:	SEVERITY OF INJURY:	PHONE #:
Email ADDRESS:		Email ADDRESS:
SURVIVOR REGISTRATION FORM		
NAME and AGE:	ANY INJURIES (describe):	EMERGENCY CONTACT NAME:
ADDRESS:	LOCATION OF INJURY:	ADDRESS:
PHONE #:	SEVERITY OF INJURY:	PHONE #:
Email ADDRESS:		Email ADDRESS:

G2. LINCOLN COUNTY SCHOOLS CACHE INSTRUCTIONS

LCSD Disaster Cache Instructions

READ THIS FIRST

Incident Commander: As the administrator, you are in charge of your students and staff.

Priorities: These are your first five priorities:

1. **Student Safety** (Accountability, Supervision, & Security)
2. **Immediate Life-Safety Needs** (Medical & Missing People)
3. **Family Reunification** (This will be ongoing)
4. **Immediate Basic Needs** (Stay Dry & Use the Restroom)
5. **Ongoing Basic Needs** (Shelter Tents, Food, Water, & Communications)

Assess the Situation: Depending on the disaster and conditions at your school, you may decide to implement some priorities simultaneously, adjust the order of them, or establish different priorities. Use your best judgement.

Disaster Cache: Remember that you have a disaster cache. Your *Area Master Key* will unlock it. Don't open it until you need it. Then it will need to be guarded or locked right back up. Assign someone to protect your cache. These are your survival supplies for the near future.

Read Instructions for Priorities 1-5 (next page): Then appoint leaders for each task and distribute the task instructions. You are in charge. Do not take on the tasks yourself. Your job is to oversee the leaders of these tasks and the overall operations. The "Operations Manual" inside the Disaster Cache has all the instructions printed up for you to distribute.

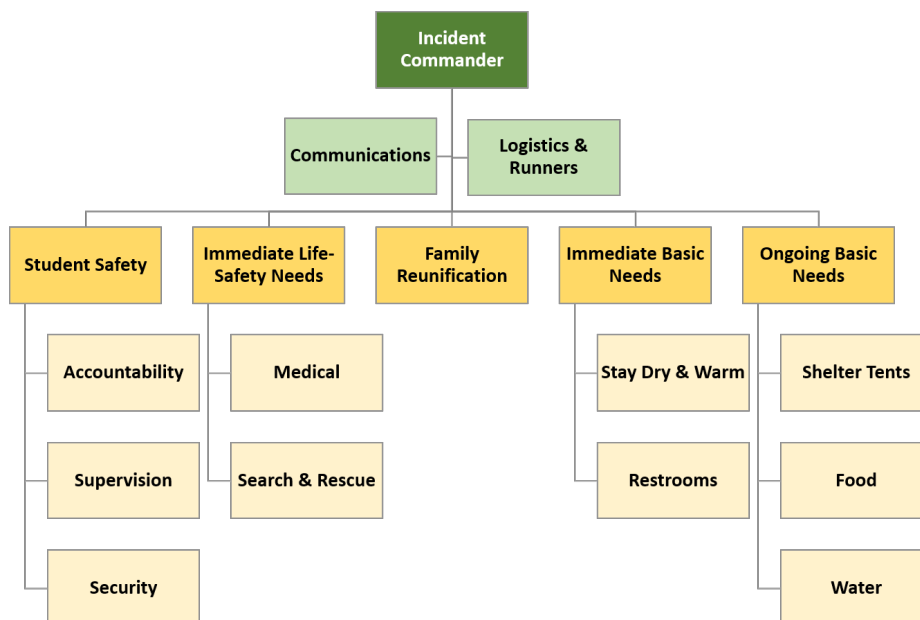

G2. LINCOLN COUNTY SCHOOLS INSTRUCTIONS, CONTINUED**PRIORITY 1: STUDENT SAFETY: (Accountability, Supervision, & Security)**

- **Student Safety:** Immediately Account for Everyone (students, staff, visitors) like you do during fire drills. Supervise all students. Teachers should keep students corralled together and encourage and engage them. Do not let students wander off or leave, and do not release them to a family member until they go through the formal Family Reunification procedure. Security and accountability are essential.

PRIORITY 2: IMMEDIATE LIFE-SAFETY NEEDS: (Medical & Missing People)

- **Medical:** Put your Health Assistant or another staff member in charge of establishing a medical treatment area. Draw from staff who are First Aid certified and Teen CERT students if available. Gather the medical supplies from the Disaster Cache and any you were able to evacuate with. Some staff may have first aid kits in their cars they are willing to share. Appoint a team to erect a large tent from the disaster cache to be the medical treatment area. Get the four cots from the disaster cache to use in the medical treatment area tent.
- **Search & Rescue/Teen CERT:** If you have a Teen CERT teacher, connect with them to assist with next steps. If you are missing any students, staff, or visitors, the Teen CERT teacher may be able to deploy Teen CERT for search and rescue missions if conditions are safe and if they have access to their gear. Teen CERT can also assist your Health Assistant with setting up a medical treatment area and with first aid and disaster medical operations. They may also be sent on missions to salvage things from the school. If you don't have a Teen CERT near you, do your best. There is protective gear and search and rescue equipment in your disaster cache. Find out among the staff who is skilled and trained in rescue operations. You may also be able to use your two-way radio to notify your nearest high school of search and rescue needs.

PRIORITY 3: FAMILY REUNIFICATION

- **Family Reunification:** Immediately appoint a team of staff to implement your Family Reunification procedures. Parents/guardians who are able, may begin showing up at school within minutes. Remember that your Family Reunification supplies are located in the bottom zipper section of your SAFE Team Go-Kit. Follow these procedures strictly, keeping accurate records of all students released to parents/guardians. When checking in parents/guardians, see if they have any special skills you might need (medically trained, search & rescue trained, Ham radio operator, etc.). Some might be willing to stay and help you set up systems and get stabilized.

G2. LINCOLN COUNTY SCHOOLS INSTRUCTIONS, CONTINUED**PRIORITY 4: IMMEDIATE BASIC NEEDS: (Stay Dry, Use the Restroom)**

- **Get Out of the Rain/Cold:** Try to keep staff & students dry and warm. There are enough rain ponchos in the cache for one per person. Follow “Stay Dry & Warm” Instructions.
- **Restrooms:** Immediately establish restroom areas. Follow “Restroom” Instructions.

PRIORITY 5: ONGOING BASIC-NEEDS (Shelter Tents, Food, Water, Communications)

- **Shelter Tents:** Assess the conditions and determine where to set up a Camp Area for your staff and students. Stay away from buildings and anything else that could fall on the tents. Appoint a team to draw up a plan and implement it. Follow “Shelter Tent” Instructions.
- **Food:** Put your Kitchen Manager in charge of establishing a makeshift outside kitchen and food distribution plan. Follow “Food” Instructions.
- **Water:** Appoint a team to establish a water distribution plan. See “Water” Instructions.
- **Communications:** Set up a Communications Tent. Establish a board for Announcements and another for Messages. Get creative as you figure out needs and capabilities. Use two-way radios, but do so sparingly to preserve the batteries for as long as possible. Check in on the radio with your neighboring schools to give and receive status updates. If school buses are nearby, you may be able to use their bus radios to communicate farther out.
- **Logistics Team:** Appoint a Logistics Team to gather and distribute things that are needed for operations. They can draw from the disaster cache. They can also arrange to salvage things from school if it is safe to do so, such as:
 - Custodial Closets: toilet paper, soap & hand sanitizer, trash cans & liners, paper towels.
 - Health Room: medical supplies, student records.
 - Kitchen: food & cooking supplies.
 - Office: two-way radios, incident command supplies.
 - Misc.: fire extinguishers, yellow/gray toilet buckets, student backpacks, etc.

G2. LINCOLN COUNTY SCHOOLS INSTRUCTIONS, CONTINUED**STAY DRY & WARM**

Shelter and warmth are key elements to survival. Work to keep staff and students dry and warm. This will help prevent hypothermia.

Rain Ponchos: There are enough rain ponchos inside the cache for one per person. These can help keep students and staff dry.

Plastic Sheeting and/or Tarps: For staff who were able to evacuate with their classroom shelter-in-place toilet buckets, the plastic sheeting inside the buckets may be able to be used to huddle under to try to keep dry until the tents are set up. There are large tarps in the disaster cache that can be used in this way too.



Vehicles: If there are school buses nearby, perhaps students & staff can take shifts warming up inside the buses. Some staff may be willing to have students huddle in their personal vehicles to warm up. This is a survival situation and you must be creative, while always keeping safety at the forefront of decision-making.

Dugouts: You can also see if softball/baseball dugouts are available and safe to gather inside.

Blankets: There are enough Mylar blankets inside the cache for one per person. These blankets will keep you very warm, but they can tear easily. Each person will need to be instructed to and reminded to take very good care of their Mylar blanket. They may need to use it for several weeks. Label everyone's blanket with a sharpie.

Hats: Some caches have knitted hats.

Salvage: Salvage what you can from each school building, if it is safe to do so.

Shelter Tents: See "Shelter Tents" Instructions for establishing a tent camp area.

G2. LINCOLN COUNTY SCHOOLS INSTRUCTIONS, CONTINUED

RESTROOMS

In a catastrophic disaster when the sewer and water system is not operational, you will have to be creative, disciplined and strategic about restroom and sanitation needs. Here are some things to consider:

Initial Considerations: Immediately set up eight temporary restrooms. Each will have a POOP & PEE bucket.

Pop-up Privacy Tents: Locate the 8 pop-up privacy tents inside the cache. Pitch the tents and secure them tightly with stakes, rope, and sandbags.

Toilet Seat Lids & Buckets: All of our classrooms have 5-gallon buckets with toilet seat lids. Gather 16 toilet buckets and find the 8 POOP & 8 PEE labels inside the cache. Affix the labels to the buckets and place 1 POOP bucket and 1 PEE bucket inside each Privacy Tent.



Toilet Paper from School: If it is safe to do so, attempt to salvage toilet paper from the schools.

Small Buckets & Hand Shovels: Locate the 8 small buckets and hand shovels inside the cache. Fill the small buckets with carbon materials like dried leaves, wood chips, oat straw, sawdust, shredded paper or cardboard. Place a filled bucket and a hand shovel inside each pop-up privacy tent. This will be used to cover up Poop.

Porta Potty: Many of our schools have porta potty units at their athletic fields. Check to see if there are any around. They may provide a temporary place for toileting needs while you are constructing human-waste disposal sites.



IMPORTANT: READ THE DOCUMENT A Sewer Catastrophe Companion (Danielsson & Lippincott, 2012) for instructions on using 5-gallon buckets for safe PEE and POO toilet systems. It is easy to follow and set up, and includes instructions for composting human waste. It also has instructions for constructing a handwashing station. The instructions are in the Disaster Cache Operations Manual located inside each cache.

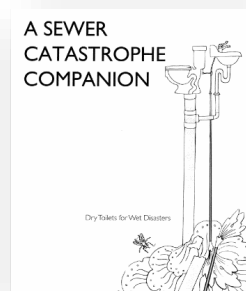

G2. LINCOLN COUNTY SCHOOLS INSTRUCTIONS, CONTINUED

RESTROOM TASK CARD		
Materials:	<ul style="list-style-type: none"> • Pop Up Privacy Shelter • 5-gallon Bucket & PEE Label • 5-gallon Bucket & POOP Label • Two Toilet Seats & Lids 	<ul style="list-style-type: none"> • Plastic Liners • 3-gallon Pail • Hand Shovel • Restroom Signs & Clips
<ul style="list-style-type: none"> • Hand Sanitizer • Lantern • Tissue Packets • Restroom Instructions 		
INSTRUCTIONS:		
	<ul style="list-style-type: none"> • Set up a Pop-up Privacy Shelter and hang the Restroom sign above the door. • Hang a lantern from the cross beam inside the pop-up shelter. • Locate one 5-gallon bucket and affix a PEE label to it. Place the toilet seat/lid on the bucket. • Locate one 5-gallon bucket and affix a POOP label to it. Line it with 2 plastic bags. Place the toilet seat & lid on the bucket. • Place the PEE and POOP buckets in the shelter. • Find a 3-gallon pail & hand-shovel and fill the pail with a carbon material like dried leaves, pine needles, sawdust, etc. • Place the filled pail and hand shovel next to the POOP Bucket. • Hang the laminated Restroom Instructions Sheet inside and outside the Shelter. 	
NOTE:		
<ul style="list-style-type: none"> • The PEE bucket is for Pee only - no toilet paper or Poop. Close the lid when done. • The POOP bucket is for Poop and toilet paper – no Pee. Use the hand shovel to sprinkle about a cup of material from the 3-gallon bucket to cover the poop. Close the lid when done. • Keep PEE and POOP separate to minimize odors. 		

G2. LINCOLN COUNTY SCHOOLS INSTRUCTIONS, CONTINUED

WATER

Water is needed to survive! In a catastrophic disaster when water supplies are very limited, you will have to be creative, disciplined, and strategic about water collection and distribution.

Water is needed for drinking, cooking, and sanitation. Here are some things to consider:

Warning—Read this First: If you suspect the water is unsafe because of chemicals, oils, poisonous substances, sewage, or other contaminants, do not drink the water. Do not drink water that is dark colored, has an odor, or contains solid materials. Err on the side of caution.

Water Collection Systems: You will need to set up multiple water collection systems immediately. Be creative. Use buckets and containers of all sorts to collect rain water. Set up systems with tarps, pipes, gutters, whatever you can come up with to collect rain water. You will need a very large amount of water for a very long time to work to keep everyone hydrated and healthy. Do not wait. Set up these systems immediately! You never know when you will get rain. Use the Water Filter Straws to drink water that you have collected.

Creeks/Streams: You may also consider collecting water from creeks, streams, lakes, ponds...but ONLY IF they have not been contaminated by tsunami waters. Water sources that have been inundated by the tsunami will carry a lot of hazardous materials in them as well as salt water. Also check the creeks/streams for other possible sources of contamination. Boil water collected from creeks or streams if feasible.

Water Filter Straws: Assign and distribute the [Aquamira Frontier Emergency Water Filter System](#) straws as needed. These should be used to filter water collected from creeks, streams, rain and other sources. The cache has enough water filter straws for 1 per person. They each filter 20 to 30 gallons of water depending on the model in your disaster cache. See water filter straw instructions located in the caches.



Water Barrels: Ration water carefully from the 55-gallon water barrels. Make it go as far as possible. This is good drinking water. Save this water for drinking rather than sanitation. Double check the expiration date on the water barrels. They have a water purifier solution which keeps the water safe for drinking for 5 years. If the water is expired, either boil it before drinking it or use it with the water filter straws.

Water Heater: Depending on the situation at your school, you may be able to get water from a water heater unit at your school. Review the Water Heater Siphon Instructions located in the disaster cache to determine if this is a possibility.

Boiling Water: When in doubt, boil water to purify it. Filter cloudy water using coffee filters, paper towels, or a thin cloth. Bring the water to a rolling boil for at least one full minute. Let the water cool before drinking. Add two drops of household bleach (non-scented) per gallon to maintain water quality while in storage. Avoid using bleaches that contain perfumes, dyes and other additives.

G2. LINCOLN COUNTY SCHOOLS INSTRUCTIONS, CONTINUED

WATER CONTINUED

Expired Survival Water Pouches: If there are expired pouches of water in your cache, you may be able to use them for sanitation purposes or with the water filter straws or system for drinking water.

LifeStraw Community Water Filtration System: Each disaster cache has two or three large water filtration systems (see photo). The instructions are inside the Operations Manual binder and inside each box. These filtration systems can be used for filtering any expired or questionable water in the disaster cache. They can also be used for filtering rain water, water obtained from water heaters, or from fresh water sources that were not contaminated by tsunami waters or other hazardous materials.



G2. LINCOLN COUNTY SCHOOLS INSTRUCTIONS, CONTINUED

FOOD

In a catastrophic disaster when food supplies are very limited, you will have to be creative, disciplined, and strategic about food distribution. Here are some things to consider:

Food in School Kitchens: We hope it will be safe to enter the school to salvage food and cooking supplies. If you deem it is safe for buddy teams of staff to go in for very short periods to salvage things, use the hard hats, leather gloves and other protective gear in the Search & Rescue kit to enter the school. The food in our school kitchen is almost all edible without being cooked. Work with your kitchen staff to devise a plan to use this food. Some considerations:

- Carefully plan the rationing of food. You may be on your own for several weeks. Make the food go as far as possible. You will probably have to think differently about portion size, frequency of meals, etc.
- Make an inventory of what you have. Devise a written plan based on what you have and how many people you are caring for. Make it stretch out for as many weeks as possible.
- Open refrigeration units as infrequently as possible. Work to make a list of what is inside each refrigeration unit so you can plan without having to open the units very often.
- Eat perishable foods first.

Food Buckets: Each disaster cache has a supply of 30-yr shelf-life survival food such as oats, beans, and rice in sealed buckets. These will need to be cooked and will require water. If safe, attempt to obtain pans and other cooking supplies from the school kitchen. But be sure to eat any perishable foods available first.

Survival Food Bars: Some caches have a stock of survival food bars. These food bars are perforated so they can be easily rationed. Use this food source last, since kitchen food sources may spoil with no electricity to keep them fresh.

The survival food bars should have a very tight seal to each package. If the seal is broke (if it appears to have air inside the package), the food is not safe to eat. It must be discarded.



The survival food bars have an expiration date. If the seal is fully in place and it is not expired, it should be safe to eat. If the seal is in place and it is expired, you will have to decide whether or not to eat it. MREs (meals ready to eat) are usually good to eat years beyond their expiration date as long as the seal is fully in place. In a survival situation, you will need to make that difficult decision.

Local Forest Foraging Guide: Determine who knows about edible foods that may grow near the school and make a task group to organize and begin looking for and harvesting edible foods. There are laminated picture guides of local foods that grow here in the Pacific Northwest in the disaster cache Operations Manual binder.

G2. LINCOLN COUNTY SCHOOLS INSTRUCTIONS, CONTINUED

SHELTER TENTS

Camp Area: Assess the conditions on campus and find a suitable place to establish a Camp Area. Stay away from buildings and anything else that could fall on the tents. Expect aftershocks. Draw up a plan and implement it.

Tents: Consider how to set up a “Camp Area”. Think about how school classrooms are configured with walking space (halls) in between classrooms and other areas. Schools also have gathering areas (MP Rooms, Cafeterias, etc.). Position the tents practically, in a manner that will allow for movement and access. Consider how to label them so that students and staff can be assigned a tent and easily identify which tent they are assigned to. You may just use a sharpie pen to number the tents. There are step stools in the disaster cache to assist with reaching the beams for attaching the side panels.

Tip: Rain will gather on and fall from the top of the tents—this may be a water collection source. Remember this when positioning the layout and organization of tents.

Secure Tents: Stake, tie-down, and secure the tents extremely well. This is very important. The wind can easily pick up these units, causing injury. Work to secure them firmly. Consider using the fencing on the athletic fields as part of the tie-down structure. The cache contains heavy duty stakes, rope, and enough sandbags (you’ll need to fill them) for each stake. Do your best. Get creative. Think about the supplies available to you that you can salvage from the school that may be used to help secure the tents. Do not underestimate the power of the wind. **Secure tents firmly.** Attach orange flagging tape to the tie-downs to help prevent tripping hazards.

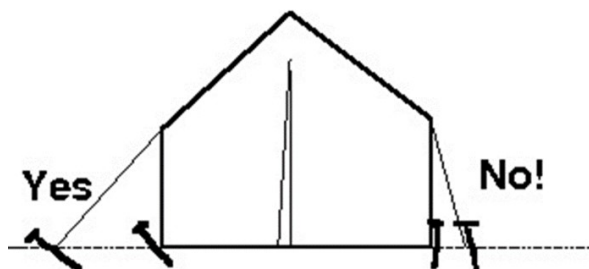

Heat Sources! Do not use any heat sources inside the tents. This is a very important safety requirement! Do **not** have small campfires in the tents, do **not** use small space heaters (not that there will be power to do so anyway); and do not use any kind of heat source in the tents. The tents are flammable.

Occupancy: Most of the tents are 10’ x 20’ and can be used to shelter a classroom full of students. There are pole crossbeams that can be used to hang fabric or shower curtains or some other kind of screen for partitioning out sections of the tent if needed. Some of our caches have smaller camp-style tents. Adjust your plan according to what is available in your cache.

Floors: The tents do not have floors. There are enough 10’ x 20’ tarps in each cache for the floor of each tent. You may also be able to salvage things from the school to raise the floors and make the floors more practical and resistant to the damp ground.

G3. SAFE HAVEN HILL EMERGENCY COMMAND PROCEDURES & TASK PROTOCOLS

Emergency Command Procedures: Here are a set of instructions to help you use the resources in this cache and aid you in the next few days. Please know that these procedures and protocols have been made with our best intentions and we hope they will serve you well. This cache is a work in progress so you may find it somewhat incomplete. We did what we could, with all of you in mind, and we wish you the best as you move through this difficult time. If you are reading this, you are the Incident Commander for the evacuation site until someone more qualified takes your place.

Mission: This emergency command procedure will help you:

- Establish an initial Incident Command
- Evaluate the site for any safety concerns and assess the group of evacuees
 - Set up camp and communications, and deploy cache resources
 - Prepare the group for the move to the community college shelter, when it safe to do so.

Your role:

- Provide a single point of leadership and direction
- Assess the situation and determine priority actions
 - Assign team leaders to implement individual protocols and priority actions
 - Make decisions as needed and as informed by the chain of command as communications are established
 - Be a single point of information - i.e. team leaders report to you and you help share critical information with the team leaders and the group at large.

Safe Haven Hill Incident Command Structure

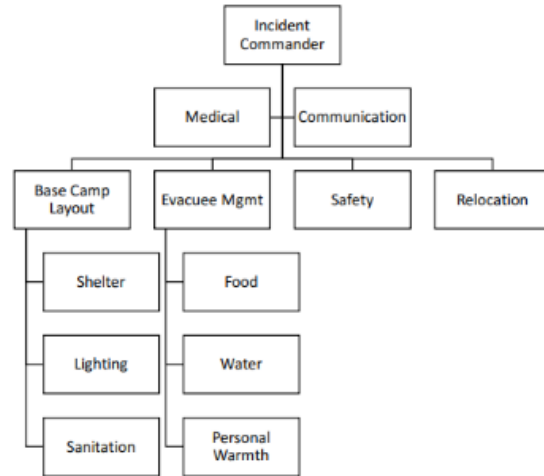

Protocol:

A. Establish the initial Incident Command: Assess the status of the group.

1. Address the group as a whole. Be positive and reassuring and encourage patience and team work.
2. Assign Team/Protocol Leaders to assist with tasks. If you do not assign a Protocol Leader, then you (as Incident Commander) are responsible for the tasks of that specific protocol.
3. Get a quick assessment of the group:
 - size and condition of the group,
 - immediate medical needs,
 - their skill sets (medical, communication, etc.),
 - equipment (not included in the cache inventory i.e. personal radios, sat phones, medical kits, etc.),
 - willingness to participate.
4. Communicate that there is a plan in place and you have the instructions for that plan.
5. Identify the most immediate and pressing needs.

Protocols	Protocol/Team Leaders name
Medical	
Shelter	
Safety	
Base Camp Layout	
Lighting	
Communications	
Sanitation	
Water	
Food	
Personal Warmth	
Evacuee Management	
Relocation	

G3. SAFE HAVEN HILL TASK PROTOCOLS, CONTINUED**Emergency Command Procedures, continued**

B. Deploy the Cache: There are a number of protocols (sets of instructions) in this box that will help you use the resources and equipment in this cache.

1. Identify one person to take a leadership role (Team Leader) for each protocol based on their skills or willingness.
 - Assign one person to each protocol starting with medical.
 - Record the Team Leader's name next to the protocol list below to help you keep track.
2. Hand the Team Leader a copy of their protocol.
 - There are two copies of each protocol in this binder- one for the team leader and one for you (just for background).
3. Have each Team Leader recruit the number of helpers appropriate to the task.
4. Instruct the Team Leaders to implement their task and check in with you if they have any questions.
5. You may need to set priorities depending on conditions and number of people in the group, i.e. setting up the medical tent, personal warmth and water distribution before doing the lighting, food and tents depending on things like weather and daylight. Use your best judgment and trust your instincts.

C. Set up Camp and Take Care of Evacuees

1. Use Team Leaders to mark off their area and take charge of their checklist responsibilities.
2. Be a single point of information. Team Leaders report to you & you help share critical information with the Team Leaders & the group at large.
3. Oversee the process and make decisions as needed and as informed by the chain of command as communications are established
4. Continue to assess the situation and determine priority actions. Identify other needed tasks and assign someone to accomplish each task.

D. Prepare Group to Move to Community College

1. Remind folks the safest place to be is on this hill until you get the all clear to move. Even if there is no flooding, aftershocks and secondary waves are a risk.
2. When the Communication Team Leader gets the all clear from the City or County, inform the group that they can now move to the community college shelter.
3. Support Relocation Team Leader with planning and communication with evacuees.
4. Navigate the group to the college and check in with the college incident commander.

Note- New Incident Commander

1. You are the incident commander until someone with more experience takes your place.
2. When transitioning to a new incident commander:
 - pass along the event history thus far,
 - status of resources and communication,
 - anticipated next steps,
 - identify the Team Leaders of each protocol to the new commander.
3. Make sure the Team Leaders know of the transfer.

G3. SAFE HAVEN HILL TASK PROTOCOLS, CONTINUED

Communications Protocol:
Materials:
<p>Protocol:</p> <ol style="list-style-type: none"> 1. Select members of the Communication Team. 2. Get the names of who is at camp from the Evacuee Management Team Leader. 3. Create an inventory of communication equipment and communication personnel. <ul style="list-style-type: none"> • Batteries: Note that all of the batteries in the cache are in this “Command” Box. We suggest prioritizing communications if batteries are in short supply. 4. Establish communications. There are multiple types of radios in the Command Box. Continue trying with the different types until communications are established. It may be awhile before the City of Newport and/or Lincoln County Emergency Command is up and running, and some more time before they can address your needs. Please be patient. 5. Check in with the Medical Team Leader and get the list of any critical medical cases. 6. Communicate with the Emergency Command the number of evacuees, the list of any critical medical cases and the general stats of the Safe Haven Hill Camp. 7. If possible, communicate with other evacuation sites. People will be more likely to stay put if they can get news of loved ones. 8. Communicate frequently with the Incident Commander and come up with a plan to communicate with the whole group to let them know what the plan is and how it is being implemented.

Camp Layout Protocol:
Materials: Camp layout map
<p>Protocol:</p> <ul style="list-style-type: none"> • Use the camp layout map to help other teams locate their areas. • Adjust the camp layout based on current weather (prevailing winds or rain), number of evacuees, and current conditions on the ground. • Document any changes to the layout on the map and communicate changes to Emergency Command.

Rough layout of SHH

Canopy shelters-6 20x10

Personal tent area

Latrine pit?

Picnic table

Toilet buckets with shower curtains stalls

Med tent 12x12

Main Cache #1

Water Cache #2

Power pole

Blue tarps-20 20x16
Used for sleeping areas between canopy, distribution around cache, over toilet buckets

Inside ID 152.5" x 95"

G3. SAFE HAVEN HILL TASK PROTOCOLS, CONTINUED

Shelter Protocol: Use this protocol to set up tents and other shelter for Safe Haven Hill. There are a variety of tents and tarps, follow these instructions to maximize space use.



Materials:	• Sand bags-30	• Tent stakes-100	• Rope	• rolls of 6 mm clear plastics-2
• 20 x 10 canopy shelters-6	• Shovels	• Hammer	• 16x20 blue tarps-20	• Shears
• Camp layout map				

Protocol:

- Review the camp layout map and confirm the best flat ground for canopy layout.
- Set up the canopies one at a time following the directions in the canopy boxes. Note that the boxes are heavy! Please use appropriate caution to prevent injury.
- Place the canopy door opening east or west depending on the prevailing wind.
- If possible, each canopy should be set up in a line with room for a 16x20 blue tarp in between.
- Fill sand bags with dirt using the shovels in the cache.
- Secure the canopies with tent stakes using the hammer in the tool box and sand bags as needed.
- Use the shears in the tool box to cut floors for the canopies from the 6 mm clear roll of plastic.
- If needed, hang a blue tarp between each canopy using rope.
- Use the shears in the tool box to cut floors for the tarps from the 6 mm clear roll of plastic.
- Additional blue tarps can be hung with the rope off the sides and front of the cache to expand covered areas in camp.

Note: pallets and plywood from the cache can be used as flooring if needed.

Drinking Water Protocol: Emergency ration 1 gal/person/day

Materials:		• Water barrel siphon pump		• Cups
• Water barrels in a variety of sizes		• 5-gal water jugs of a variety of types with spigots		• Sharpies
• Bung wrench				

Protocol:

- Place full 5-gal jug, cups, and sharpies at the location designated to dispense drinking water.
- Have folks label cup and save for later use.
- When jugs are empty fill from large water barrels.
- Sterilize the hard tube and the lose end of the flexible hose on the siphon pump with a bit of bleach.
- Open water barrel cap with bung wrench.
- Insert hard tube of the siphon into opening and screw the red fitting on the pump into the opening to secure the pump in the barrel.
- Place a 5-gal water jug on the ground below the barrel.
- Place flexible hose end of siphon into the opening of a 5-gal water jug.
- Pull up and push down on the red ball on top the siphon. It will take a few pumps until water starts to transfer from the barrel to the jug.
- Continue pumping until the jug is almost full.
- Release the red valve on top of the siphon to stop the flow of water. It takes some time to stop the water flow so release valve before the jug is full so water is not lost to over flowing.
- Again, place full 5-gal jug, cups, and sharpies at the location designated to dispense drinking water.
- Have folks label cup and save for later use.

Note: There is one large water barrel with a garden hose spigot on the bottom. This barrel can be used for drinking water or medical water by attaching the gray garden hose to the bottom and controlling flow with spigot handle.

G3. SAFE HAVEN HILL TASK PROTOCOLS, CONTINUED

Emergency Food Protocol: Rations, 800 calories per person per day	
<p>Materials:</p> <ul style="list-style-type: none"> • Emergency food ration bars in a variety of calorie amounts • Cutting board 	<ul style="list-style-type: none"> • 3 knives • Small zip lock bags
<p>Protocol:</p> <ul style="list-style-type: none"> • Please note: You may need to adjust the ration size based on the number of people. • Count how many emergency bars are here. Note the calorie count for each bar type. • Ask the incident commander for a head count. Assume you will need rations for two days and adjust the 800-calories per person per day ration. • Sterilize hands, knives, and cutting boards with a small amount of bleach (or hand sanitizer). • Cut bars into 800-calorie rations. • Place an 800-calorie ration in a small zip lock bag. • Hand out one zip lock per person per day. 	

Excretia Disposal Protocol:	
<p>Materials:</p> <ul style="list-style-type: none"> • 2, 10x20 canopies • Rope 	<ul style="list-style-type: none"> • 10 bucket toilets • Shovels • Shower curtains
<p>Latrine Plan</p> <ul style="list-style-type: none"> • At SW corner of the hilltop, erect 2 10x 20 canopies ordinated end to end S to N. • Under N canopies, dig a trench in the middle- lengthwise. 20” width and 3” deep. This is for Standing pee’rs and disposal. • Under the S canopies, set up 10 buckets toilet. There are for the sitting needs. • Hang shower curtains between the buckets with rope to the edges of the canopies for privacy purposes. <p>Sanitation:</p> <ul style="list-style-type: none"> • Get two buckets and label them “pee” or “poo” (or #1 and #2, etc.). • Set them up in a private space. The seat can be moved from one to the other. • Try to keep types of waste in their own separate buckets. The pee is the component that produces the bad smell in toilets that mix waste. • After using the pee bucket remove the seat and cover with a lid that closes well. • After using the poo bucket, sprinkle about a half cup of the carbon material so that it completely covers the surface of the poo. This will eliminate odors and keep flies away. • Toilet paper is okay for the poo bucket, but not for the pee bucket. • Put the toilet seat back down, ensuring it’s not airtight. Give your poo some air and it will dry out and reduce in volume. 	

G3. SAFE HAVEN HILL TASK PROTOCOLS, CONTINUED

Lighting & Power Protocol: Use this protocol to set up lighting for Safe Haven Hill. There are a variety of lights and power sources, follow these instructions to maximize lighting efficiency.

<p>Materials:</p> <ul style="list-style-type: none"> • 2 Rope lights • 2 Medical lights • 8 Lanterns for shelter canopies • 8 Collapsible outdoor lanterns 	<ul style="list-style-type: none"> • 48 Flashlights • Zip ties • 1, 100ft power cord • 2, 25ft power cord • 1 to 3 way plug adaptors 	<ul style="list-style-type: none"> • AA batteries • Rechargeable AA batteries and 1 battery charger • 11 Wind-up flashlight/radio • 21 Shake flashlights 	<ul style="list-style-type: none"> • 1 Scocket ball, • 66 Glowsticks • 2 Mounted solar panels • 2 Mounted battery packs • Propane generator
---	---	--	--

Protocol:

- For lighting inside the cache:
 - Turn on light switch (see diagram).
 - A rope light is already hung around the inside of the cache. Plug in this rope light into the electrical outlet to the right of the cache door. This outlet is run off the battery pack in the white case on the floor. It is charged by the solar panels (Renogy RNG-100D 100W Monocrystalline Solar Panel) on the roof.
 - Unplug these lights when not in use!**
- Find the yellow tubs marked lighting.
- Set up the medical tent lights. These lights should be used to help with any medical issues but can also be used to help provide bright light for organizing and camp set up).
 - Pull out both strings of medical lights- (yellow tub #1-1.b Keystone brand).
 - Find the 25-foot extension cord (yellow tub #2- 2.d) and the a 3-way splitter (yellow tub #2- 2.f).
 - Plug the two strings of medical lights together, plug the medical lights into the extension cord, and then plug the extension cord into the 3- way splitter. Unplug the rope light and plug the 3- way splitter into the electrical outlet to the right of the cache door. Plug the rope light into the 3-way splitter.
 - Hang the medical lights in the medical tent once the tent is set up with zip ties from the tool box.
 - Unplug these lights when not in use!**
- Hand out flashlights as needed (yellow tub #2- 2.a.).
 - Each flashlight needs 2 AA batteries found in the gray “Open Me First” command box.



Power System
to the right of door

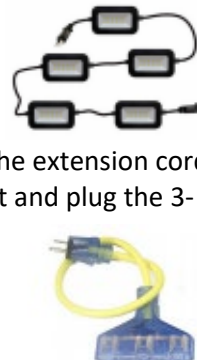

G3. SAFE HAVEN HILL TASK PROTOCOLS, CONTINUED

Lighting and Power Protocol, continued

- b. Note there are also some shake up flashlights and wind-up radio flashlights but they might be unreliable (yellow tub #3- 3.a and 3.b.).
5. Set up outdoor lanterns (yellow tub #2- 2.c).
- To expand- hold with handle facing up. Rotate the upper cover anticlockwise until the spring expands to extend the lantern.
 - Each lantern needs 3 AA batteries. Batteries may be already in the lantern but a protective sheet will need to be removed between the batteries before the light will work. Extra AA batteries can be found in the gray “Open Me First” command box d. Place outdoor lanterns around the latrines and walkways as needed.
6. Set up lanterns in shelter canopies (MalloMe brand- yellow tub #2- 2.b.).
- Unscrew the bottom of the lantern and add 3 AA batteries. Extra AA batteries can be found in the gray “Open Me First” command box.
 - Flip up the metal handles and pull up to expand the lantern which turns on the light.
 - Hang the lanterns one to a canopy using the zip ties in the tool box. These lanterns are not waterproof!
7. Put out glow sticks (yellow tub #4) where needed using zip ties from tool box.
8. Lay out the second rope light where needed (yellow tub # 1- 1.a.).
- A string light, similar to the one hanging in the cache, can be used where needed.
 - Plug in the 100-foot extension cord (tub#2-2.c.) into the 3- way splitter already in the electrical outlet.
 - Plug in the string lights into the extension cord and layout the lights where needed.
9. Set up rechargeable AA batteries and battery charger for backup communication radios and flashlights batteries.
- Pull the rechargeable AA batteries and battery charger out of the gray “Open Me First” command box.
 - Plug battery charger into the electrical outlet or into the 3- way splitter.
 - Keep a set of rechargeable batteries charged.
10. Set up propane generator.
- Roll the generator outside.
 - Start the generator.
 - Plug in the 25-foot extension cord into the generator.
 - Plug in a to 3-way splitter on to the extension cord if needed to run the light strings.
11. Hand out Scoccket ball.
- Have people roll it around and follow directions to charge any phones.



G3. SAFE HAVEN HILL TASK PROTOCOLS, CONTINUED

Relocation Protocol:

Your Role: Safe Haven Hill is an emergency evacuation location. You and the other evacuees might be on this hill for 12 hours to three days depending on aftershocks and secondary waves. When the all clear comes from the Incident Commander, your team will help the evacuees move to the shelter site at the Oregon Coast Community College (OCCC). OCCC is about 1.5 miles from your current location due east. Your task is to find the best route off the hill for this move, help the other teams and evacuees prepare for the move, and manage the move from Safe Haven Hill to the Community College shelter site.

Protocol:

1. Select members of the Relocation Team.
2. Assign a pair of team members to assess the best route off the hill. This might not be possible until the area has stabilized, but plan and assess the route as soon as possible.
3. Work with the Evacuee Management Team Leader to help continually evaluate the status of evacuees and their capability to move to another site. Build anything that will assist during the descent if necessary, as the base of the hill could have experienced scour and or pathway damage.
4. Remind folks the safest place to be is on this hill until you get the all clear to move. Even if there is no flooding, aftershocks and secondary waves are a risk.
5. Check in with the Medical Team Leader, after they have addressed life threatening issues, encourage them to start thinking about stabilizing injuries for transport.
6. When the Communication Team Leader gets the all clear from the City or County, work with the Incident Commander to determine when the relocation will occur.
7. Do a final assessment of the route before moving evacuees from one location to another.
 - Evaluate difficulty of travel for evacuees.
 - Assess for mobility impaired evacuees.
 - Assess for hazardous chemicals or dangerous conditions that would make movement more dangerous than remaining.
8. Ask evacuees to take only what they can comfortably carry. The walk up to the community college may be challenging; the group can always come back for the cache resources.
9. Ask evacuees to stay together as you all move to the shelter site.
 - Staying together will help everyone get to the community college.
 - If Evacuee Management Team has established groups, work with them to coordinate group movement.
10. Recruit volunteers that can help carry, clear the road, or perform other necessary tasks.

G4. TILLAMOOK COUNTY TASK CARDS

READ THIS ENTIRE CARD FIRST:

Then Follow the Steps:

STEP 1: DECIDE among those present who will be the Overall LEAD for the Neighborhood Gathering Site. That person is responsible to carry out the Steps listed below.

STEP 2: LOOK IN THE “OPEN THIS FIRST” BOX: Find the plastic bag packet with the OVERALL LEAD vest – Put the vest on.

STEP 3: FIND VOLUNTEERS TO BE AREA LEADS: Ask people about any special skills they might have (first aid, CERT, emergency communication, camping experience, WaSH training). Based on this, designate Area Leads: Medical, Radio, Shelter and WaSH.



STEP 4: DISTRIBUTE THESE ITEMS TO AREA LEADS

1. In the “Open This First” Box, find the plastic bag packets for each of the 4 Area Leads: Medical, Radio, Shelter, and WaSH.
2. Give a packet to each Volunteer you have designated as an Area Lead.
3. Have the Area Leads put on the Vests designating their roles.
4. Give Area Leads the boxes corresponding to their roles.

STEP 5: FIND VOLUNTEERS TO ASSIST AREA LEADS. Have each Area Lead find people to assist them.

STEP 6: The Objective: (Read this aloud before volunteers disperse):

*Our objective is to set up a **temporary site** with various **Stations** using the materials and TASK CARDS in your Neighborhood Emergency Supplies and Tools (NEST) Kit Boxes:*

- **COORDINATION & COMMUNICATION:** Set up a central location – a COORDINATION & COMMUNICATION STATION to help organize and share information. The Overall LEAD and Radio/Communication LEAD are responsible for organizing.
- **MEDICAL:** Set up a place to treat injured people – a FIRST AID STATION. Medical LEAD is responsible for organizing.
- **WASH:** Set up a sanitary place for water and bathrooms – a WaSH STATION. WaSH LEAD is responsible for organizing.
- **SHELTER:** Set up temporary SHELTER AREA STATIONS. Shelter LEAD is responsible for organizing.

STEP 7: ESTABLISH A PLACE FOR COORDINATION & COMMUNICATION: (For Overall LEAD): Along with Communication LEAD, set up the **Coordination and Communication Station** in a dry flat area. Follow the steps on the COORDINATION & COMMUNICATION STATION TASK CARD.

G4. TILLAMOOK COUNTY TASK CARDS, CONTINUED

COORDINATION & COMMUNICATION STATION TASK CARD

RESPONSIBLE PERSON(S): OVERALL LEAD

YOUR OBJECTIVES: 1. Set up an area to direct volunteers, answer questions, and monitor the situation. 2. Establish emergency communications.

DO THIS:

STEP 1. Assist the Radio Lead in setting up radio communications using the Yellow Radio. The Radio Lead should follow the steps on the **Emergency Communications Task Card**.

STEP 2. Record in a notebook who you have assigned as Leads and for which station.

STEP 3. Check in with the other Leads at least every 30 minutes. Find out what additional support they may need. Gather information from the Leads regarding the condition of the individuals in the first aid station and the shelter area. Record this in the notebook.

STEP 4. Provide at least hourly updates to all present –even if you have no new information.

STEP 5. Find other volunteers to relieve the Leads – they (and you) should rotate out every 8 hours if possible.

EMERGENCY COMMUNICATIONS TASK CARD – YELLOW RADIO INSTRUCTIONS

RESPONSIBLE PERSON: RADIO LEAD

YOUR OBJECTIVES: Gather, communicate, filter, and monitor information from and to others using the Yellow Radio. Use your charged yellow radio or find one to use from another person. You will need to have a charger station (the black cradle). Keep the Lead informed of any critical issues brought to your attention as you monitor the radio. Note – you may have individuals asking you to reach people outside of the area. These Radios only work within the area – tell them to try using their cell phones (texting may work for a short period of time).

DO THIS:

1. Make sure the radio is operating. Turn the dial on the top clockwise to turn it on and adjust volume. If the display does not light up, find a power source, such as a generator, or charge the battery with a hand-crank charger or solar power pack. Use the black adapter/cradle and cord.
2. For communication within your Neighborhood Gathering site use the yellow radio on Ops Channels (103 for Zone 3 for example or 119 for Net Control – see enclosed card for details). To communicate with your Zone Net Control use your Zone Channel.
3. Take notes on received communications – find another person to be your note taker if possible. Ask them to note the time and other important information received or transmitted.
4. Tell the LEAD Coordinator about important communications both from your site and from the Zone Net Control.
5. Ignore communications that do not affect your area.
6. See the instructions below if you are not familiar with how to operate the Yellow Radio:
 - PUSH and HOLD the large black rectangular button on the left side. Wait a moment before talking, and then speak slowly and clearly. Follow these rules:
 - Keep messages brief and communicate only important information about your situation.
 - DO NOT talk over others on the channel. Wait your turn. If the Green Light is lit, someone else is on the channel. When it's Red you can talk.
 - Do not transmit any private, personal information (a specific person's medical condition) over the radio
 - Persist. If you don't get through or can't hear a message clearly, keep trying!
 - Start each message with the name of the person you're calling – "Dave this is Sharon."
 - Speak slowly and clearly.
 - Respond with the word **Copy** to acknowledge radio communications from another person. **Repeat any instructions given to you.**
 - Use "**affirmative**" for 'yes' and "**negative**" for 'no'. End with the word **Over**.

G4. TILLAMOOK COUNTY TASK CARDS, CONTINUED

W.A.S.H STATIONS (Water, Sanitation & Hygiene) TASK CARD

PERSON RESPONSIBLE: WASH LEAD

YOUR OBJECTIVES: 1. Set up an area for purifying and storing clean water, an area for toilet facilities, and an area for hand washing. 2. Set up water collection teams.

FOLLOW THESE STEPS:

STEP 1. Get the Boxes Labeled WASH – there are 3 boxes. Get the Pop-up Privacy Tent, the toilet seat frame and buckets. Use the equipment in the boxes to set up your Stations. Consult the inventory lists and instructions in the boxes.



STEP 2. Find Volunteers to help you – you will need at least two people to locate and retrieve water using the buckets. Have them locate and retrieve at least 4 buckets of water to start.

STEP 3. Set up the Water Filtration Station

1. Get the water filtration system from Box 3 and set it up.
2. Take the clean buckets and fill them with local water.
3. Start the water filtration process.
4. Mark each container with how and when water was purified. Use Masking Tape and Sharpies to do this. Log in notebook.
5. Maintain the water purification process as needed to produce drinkable water.

STEP 4. Set up Sanitation Station(s)

1. Locate a private area for toilet facilities.
2. Set up the privacy pod from the Kit and use tarps or other materials to create a private space.
3. Use additional buckets to create additional toilet facilities, following the instructions on the enclosed WASH instruction sheets.
4. Locate a large bucket or barrel to store used Wag Bags. Box 2 contains wag bags.
5. Place a sign on the bucket or barrel to that says it is for disposal of waste. Use Masking tape and Sharpies to do this.
6. Establish a process to handle human waste using the information contained on the instruction sheets.

STEP 5: Set up the Hygiene Station

1. Locate an area for hand-washing stations near the sanitation area.
2. Use the hand washing station from Box 3 to set up the hand washing station.

G4. TILLAMOOK COUNTY TASK CARDS, CONTINUED

FIRST AID STATION TASK CARD

PERSON RESPONSIBLE: MEDICAL LEAD

YOUR OBJECTIVE: You are in charge of the First Aid Station until you are relieved. You and others should provide limited first aid to those in need of medical care. Find volunteers with first aid training and experience to assist you. You will need to determine what level of care is needed using basic triage standards. You might not be able to treat everyone in need of care. Provide only basic treatment: treat for shock, stop bleeding, or stabilize broken bones.

FOLLOW THESE STEPS:

STEP 1: Set up the triage area.

1. Locate a dry space uphill and upwind from any nearby hazards.
2. Lay out **first aid supplies** from the Box labeled MEDICAL
3. Lay out the tarps to receive injured:
 - **Red tarp**—Immediate care
 - **Yellow tarp**—Delayed care
 - **Green tarp**—Minor injury
 - **Black tarp**—Morgue. Locate this tarp in a secure location where you can't see it from the treatment area and away from the Neighborhood Gathering Site.



STEP 2: Deploy your team to each triage station and provide as much comfort and care as possible. (You might not be able to provide care to those critically injured).

STEP 3: Document each injured person in the Notebook from the Kit. Use masking tape and a Sharpie to create a label for each person and place on the person's arm or leg. Record the following:

- Name (if known).
- Description: age, sex, estimated height.
- Clothing.
- Injuries or Status.
- Any treatment applied.

STEP 4: If there are deceased persons, attempt to document their name, age, or any identifying characteristics and record them in the notebook. Use masking tape to create a label for each person and place on the person's arm or leg.

G4. TILLAMOOK COUNTY TASK CARDS, CONTINUED

SHELTER AREAS TASK CARD

PERSON RESPONSIBLE: SHELTER LEAD

YOUR OBJECTIVE: You are in charge of setting up a SHELTER at the Neighborhood Gathering Site. You are tasked with locating, preparing and staging Shelter areas with heat and light to temporarily house people and pets.

FOLLOW THESE STEPS:

STEP 1. Get the Box labeled “Shelter” and take out the contents.

STEP 2. Find Volunteers to help you.

STEP 3. Create a dry space for people and a separate space for pets in one of these areas. Use the tarps and ropes. Here are some suggestions:

- An open garage or other undamaged structure.
- A clearing or flat, dry surface away from potential falling debris.
- A ring of vehicles with tarps pulled between cars to make a shelter.
- An area of trees deemed safe. String the tarps between them.

STEP 4. Set up a heating station.

- Create a Fire Pit Team including a person in charge of fire safety.
- Set up fire pits in safe areas to make small, containable fires.
- Have volunteers gather and stack three different sizes of wood: small tinder, small kindling, and dry burnable logs. Use the fire starter supplies in the Box.
- Set up the Bio-Lite Stove according to the directions in the box.

STEP 5. Set up Lighting. Create a lighting team and have them Use LED lanterns and other lighting supplies from the “Open Me First Box”, and use any other available lights.

STEP 6. Get people and pets settled; Gather information and record it.

- Provide information about the Neighborhood Gathering site and the name of the OVERALL LEAD Coordinator to those present.
- Check to see who has a go-bag or other survival items.
- Ask each person to wear a name-tag. Use Masking tape and Sharpie’s to create tags.
- Assess each person’s physical and mental health as best you can– if you have concerns, share them with the Lead.
- Write basic information about each person in the Notebook. (Name, Age, any special needs, any special skills)
- Collect requests for communications and report them to the LEAD Coordinator.

STEP 7. As people get settled, ask for help with keeping people comfortable, warm and calm. Provide reassurance and have a confident attitude. Distribute Mylar blankets and ponchos if needed.



G5. EXAMPLE DECISION-TREE FOR OPENING A CACHE

This decision-tree was closely modeled after the [Wellington Region Emergency Management Community Emergency Hub Program](#), New Zealand. The concepts and much of the text are very similar. Some things were changed to reflect Disaster Caches rather than Hubs. Planning teams can refer to either to get ideas for creating their own.

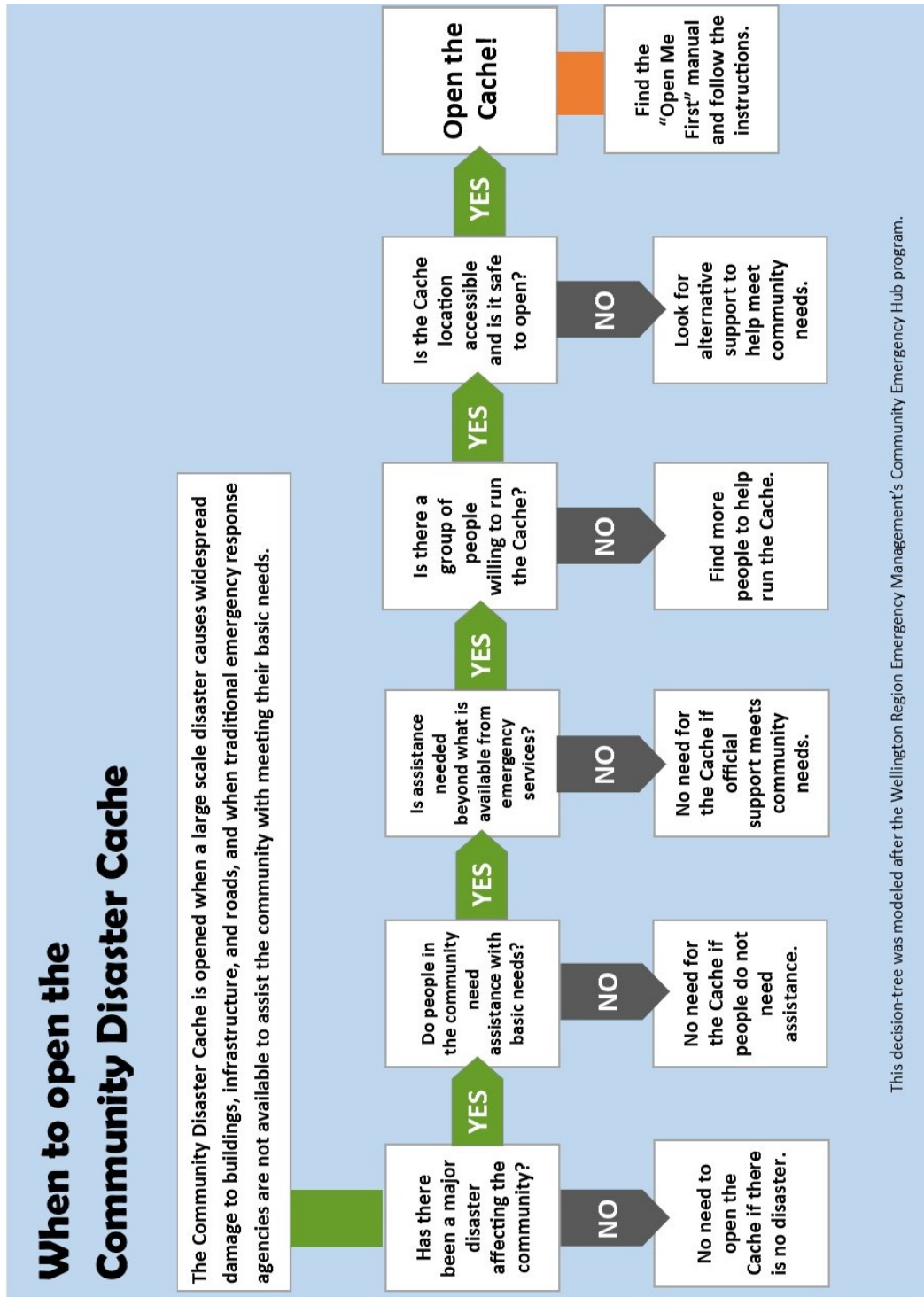

G6. TASK CARD TEMPLATE

NAME OF TASK:			
ASSIGNED TO:			
REPORT TO:			
Supplies & Equipment Needed:	• • • • •	• • • • •	• • • • •
<u>INSTRUCTIONS:</u>			
• • • • • • • • • • •			
<u>NOTES:</u>			
• • • •			

DISASTER MORGUE EXAMPLES

H1. Depoe Bay Fire District CERT Morgue Protocols

H2. Joyce Mortuary Plan

APPENDIX H: DISASTER MORGUE EXAMPLES

Overview: This section features two approaches to dealing with the deceased during a large, catastrophic disaster such as a Cascadia subduction zone earthquake and tsunami when professional responders are not available to perform these important roles.

H1. Depoe Bay Fire District CERT Morgue Protocols: The first example was developed by CERT trainers from the *Depoe Bay Fire District's Community Emergency Response Team (CERT)*, with the assistance of several other local

CERT leaders, fire & rescue personnel, and community partners. It was created to provide basic guidance to their CERT team who anticipates being isolated in small rural areas throughout their district during a catastrophic disaster such as a large Cascadia subduction zone earthquake and tsunami. The assumption is that they will not have access to professional responders but will need to make decisions regarding those who have died. At the time the protocols were developed, the State of Oregon did not have any guidance for isolated communities on how to manage the deceased during this type of disaster.

H2. Joyce Mortuary Plan: The second example was developed by Jim Buck, the leader of the *Joyce Emergency Planning & Preparedness (JEPP) Team*. In October 2019, Mr. Buck met with the Clallam County, Washington, coroner to have the plan approved. They are working to establish mortuary kits and instructions for each of their five operational areas.

These protocols are meant to provide examples. They are included in this *Guide* so that other jurisdictions can get ideas for developing or strengthening their own disaster response plans. However, it is important that individual plans are developed and customized with local community partners and officials to address specific local needs, hazards, policies, and capabilities.

H1. DEPOE BAY FIRE DISTRICT (DBFD) CERT MORGUE PROTOCOLS

Depoe Bay Fire District CERT Morgue Protocols for Isolated Rural Communities during a Catastrophic Disaster

Purpose: The purpose of this training is to provide basic guidance to the Depoe Bay Fire District Community Emergency Response Teams (CERT) in surrounding rural communities who are isolated during a catastrophic disaster such as a large, Cascadia subduction zone earthquake and tsunami, who don't have access to professional responders, but need to make decisions regarding those who have died. This training will provide a framework a community may use to deal with the dead in an organized, safe, and respectful manner. The protocols will help CERT teams handle the deceased with respect and dignity, improve the psychological health of survivors, and help prevent the spread of disease.

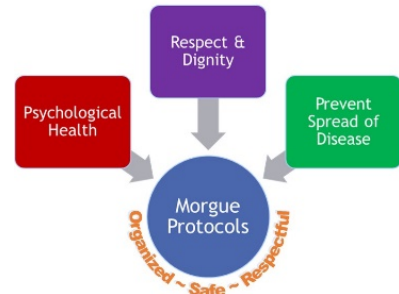

What is a CERT Morgue? A CERT Morgue is a temporary holding and processing area for people in the community who have died as a result of a catastrophic disaster. It is activated when professional responders are not readily available. However, it is not designed for criminal scenes. Below are several considerations for operating an organized, safe, and respectful morgue.

LOGISTICS & SET-UP

Designate a Space: Find a structure to house the morgue operations, such as a shed, green house, detached garage, or even a large tent. It should be located away from the medical treatment areas and away from public view. When considering a space, assess the type of structure, the condition it is in, and its location in relationship to the hazards you are dealing with. For example, will it be impacted by aftershocks? Is it located near an area susceptible to landslides? Can it be secured firmly from the wind? Having a designated space will provide privacy and will help protect the bodies and those working to prepare the deceased from the weather and other hazards.

Large Tent Canopy: Consider purchasing a 10' x 20' portable, garage tent canopy and store it in a neighborhood disaster cache for this purpose. These canopies come with sturdy steel frames, have windows for natural light and ventilation, and are easy to set up. They are cost effective and can be purchased at Costco for approximately \$230. These tents can easily be connected together if needed to expand the morgue space. However, they do not come with a floor, so a separate tarp for the ground is needed as well as supplies for securing them from the wind.

Sample Morgue Layout: Here is a sample morgue layout for a tent canopy (next page). It can be scaled or adjusted based on the space you are using and the number of victims received. There are three main sections in a morgue: 1) the Receiving & Documenting Area, 2) the Staging & Supply Area, and 3) the Body Storage Areas.

H1. DBFD CERT MORGUE PROTOCOLS, CONTINUED

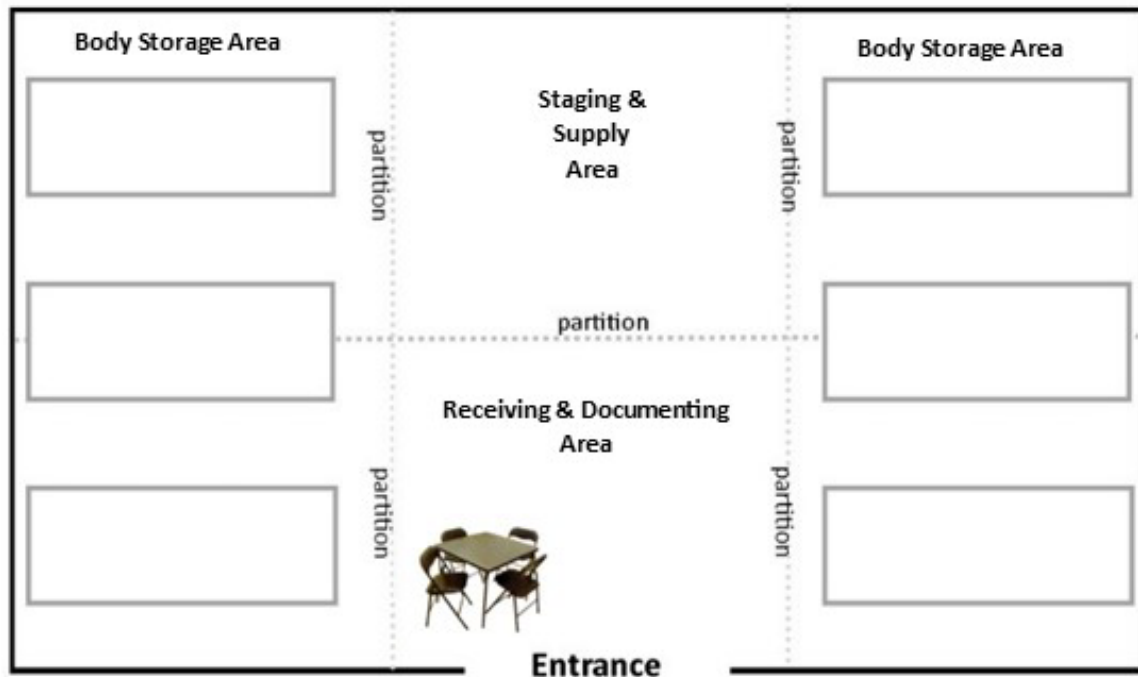

You can separate the different areas of the morgue by hanging partitions down from the cross beams of the tent canopy. You might use sheets, tarps, shower curtains, or whatever material you have available. Keep partitions closed as much as possible. This will increase privacy, minimize opportunities to see the deceased, and can improve psychological recovery. You may also be able to hang lighting down from the cross beams.

1. **Receiving & Documenting Area:** Arrange a table and chairs, if available, to one side of this area. This will provide a space to take care of all the documentation and allow room on the other side for rescuers to enter with victims.
 - a) **Tracking & Identification:** The morgue team members working in the Receiving and Documenting Area are responsible for tracking all of the morgue activities, including all victims brought into the morgue. Assign a number to each body and to any separated body parts entering the morgue. Use that same number on all their documentation. Use the three tools described below to track the identification of victims.
 - The *Morgue Tracking Form* is the overall summary tool used to document all bodies and activities in the morgue.
 - The *Wrist/Ankle Tag* is immediately attached to the wrist or ankle of the deceased as they are brought into the morgue. We do not write on the bodies, but write their assigned number on the wrist or ankle tag to accurately link the assigned number with that body.
 - An individual *Victim Identification Form* is filled out for each body or body part brought into the morgue. It provides a place to document more detailed information about each person.
 - You will need enough preprinted copies of these tracking tools to support the anticipated morgue intake for your community. You will also need various office supplies such as clipboards, paper, scissors, pens, Sharpie, masking tape, and Duct tape.

H1. DBFD CERT MORGUE PROTOCOLS, CONTINUED

- b) **Gate Keepers:** The morgue team members working in the Receiving and Documenting Area will also serve as the Gate Keepers to keep the media and general public out of the morgue. Other than the morgue team, the only people coming into the morgue should be the rescue teams bringing victims, those coming in for arranged viewings or for identification, and those moving bodies for burial.
2. **Staging & Supply Area:** The Staging & Supply Area is used by the morgue workers to store their supplies, take care of sanitation needs, and have a general area in which to perform morgue operations. In the Staging & Supply Area you will need:
- Personal Protective Equipment (PPE)** such as exam gloves, masks, goggles and some type of plastic inflection control gowns for Morgue workers to wear;
 - A **Sanitation Station** with supplies such as buckets, bottled water, soap, hand sanitizer, hand wipes, tissues, and wash cloths; and garbage cans & liners to dispose of waste.
 - A **Storage Locker** for personal belongings which will be discussed later.
3. **Body Storage Areas:** In the Body Storage Areas, designate several positions for body storage. This is where they will be processed, wrapped, and stored temporarily (details to follow).
- Logistics:** Bodies should be placed on their backs and lay side-by-side. Do not stack them on top of each other. If feasible, leave room to walk and work between each body position. You may consider making separate sections for male and female victims. This could reduce the number of bodies that will need to be viewed to identify someone. Adjust these body positions as needed based on the number of victims taken in.
 - Wrapping Supplies:** Prepare each body position in advance, so it is ready for wrapping the deceased, by laying out:
 - a sturdy sheet or blanket, which will be used to transport them after they are wrapped;
 - 6 strips of fabric spread out over the blanket, which will be used to secure the wrapping;
 - 2 contractor bags, each bag cut open part way down the middle and overlapping each other; (this is an alternative to body bags which may not be available);
 - a 4' x 6' piece of Visqueen placed inside the contractor bags to help to contain bodily fluids.
 - a *Victim Identification Form*, a *Wrist/Ankle Tag*, and a clear plastic bag for personal belongings.



H1. DBFD CERT MORGUE PROTOCOLS, CONTINUED

BODY PROCESSING

Handling the Deceased: Ideally, the deceased should only be handled three times. 1) First, when they are moved from the accident site to the morgue, 2) Next, when they are received and wrapped in the morgue, and 3) Finally, when they are moved from the morgue into the cold storage or burial plot.

Confidentiality: The morgue team must treat each body with dignity and respect, being sensitive to team members' psychological needs as well. The morgue facility must be kept secure and morgue activities kept confidential. Do not tell anyone the number of bodies or the names of any of the dead. Use the *Morgue Tracking Form* to accurately document and communicate this information directly to the Morgue Branch Director who will share within their chain of command as needed. Follow these protocols carefully, as rumors and misinformation can spread quickly, causing undue sorrow and distress.

Follow these procedures for body processing:

1. **Safety & Hygiene:** The morgue team will be exposed to bodily fluids and should wear personal protective equipment (medical gloves, mask, goggles and a plastic infection-control gown) while handling remains. They will also be exposed to unpleasant sights and scents and will have to develop their individual coping mechanisms. Follow standard CERT hygiene procedures to help prevent/reduce the risk of exposure to diseases spread by body fluids. After handling a body, immediately dispose of all items that have come in contact with the victim (gloves, towels, etc.). Tip: Improvise and use whatever resources are available to accomplish the tasks. If plastic infection control gowns are not available, you may consider using a plastic garbage bag or rain poncho to provide a barrier between your clothing and bodily fluids.
2. **Confirm Death Status:** When the body is brought into the morgue, direct them to be placed onto a prepared wrapping station. Confirm that the body is tagged appropriately (black) and is actually dead. Follow CERT protocols to attempt to open their airway using the 'head-tilt, chin-lift' method. Check for breathing – look, listen & feel. If no breaths, try one more time; if still no breaths, consider them dead. You may notice that their hands and feet have grown cold and their skin may be discolored or turn blue or purple. If a health-care professional or first responder is available, you may enlist them to make a somewhat official "death pronouncement".
3. **Assign a Number:** Using the *Morgue Tracking Form*, assign a number (001, 002, 003, etc.) to each body and to any separated body parts entering the morgue. Use that same number on all their documentation. Do not write on the body; write their assigned number (from the *Morgue Tracking Form*) on a *Wrist or Ankle Tag* to accurately link the assigned number with that body. Immediately attach the tag to their wrist or ankle.



H1. DBFD CERT MORGUE PROTOCOLS, CONTINUED

4. **Victim Identification:** Fill out a *Victim Identification Form* for each body or body part. Work to identify each body as best as possible and document carefully. This is very important since bodies will start decomposing within 12 hours without refrigeration. Leave clothes on the victim. Assuming the death is from a natural disaster and not due to a potential crime scene, carefully wash any blood or dirt off their face if feasible. This may 1) assist with body identification; 2) allow facial features to be sufficiently represented in photographs; and 3) it may help reduce trauma when family members come to view their loved one. Photograph the facial remains and any obvious identifying marks such as birthmarks or tattoos. If a full-frontal view is not permissible due to facial damage, then attempt a side profile. Include the Victim Identification Number in the pictures.
5. **Wrapping:** Wrap the deceased in a mummy-like fashion. This will help to contain the bodily fluids and keep them out of the surrounding soils and ground water if they are buried. First, fold the plastic in the foot area upwards, overlapping them and holding them in position with some duct tape. Then, fold the remaining plastic over the facial area. This will protect the remains and also allow for an opening of the wrap for victim identification should that occur before storage efforts are undertaken. Using the 6 strips of fabric or binding under the contractor bags, securely bind up the entire “package” to contain the remains and minimize shifting of the remains when moved. Place a long piece of duct tape down the entire package and use a sharpie to write the victim ID number. If the remains must be buried temporarily, the tape with the number will show up as remains are recovered after the disaster.



6. **Personal Belongings:** Personal items, such as jewelry, wrist watches, cell phones, eye glasses, etc., should be carefully logged and secured in an effort to prevent potential theft. Designate a storage container or locker of some sort which will serve as a temporary vault in which all personal belongings will be secured after properly logged. Determine how this will be secured. To prevent accusations of theft, two people should work together to log and secure each item. Every individual item should be: Listed and described on the *Victim Identification Form*, minimally cleaned if

H1. DBFD CERT MORGUE PROTOCOLS, CONTINUED

necessary, and placed in a clear plastic bag marked with the exact same ID number assigned to the victim. Seal the top of the bag with sturdy tape. Place the bag in the secure storage locker. In the “Personal Belongings” section on the *Victim Identification Form*, indicate the name of the people logging the items.

When loved ones request the personal belongings, do not show them the bag of items, instead, have them describe each item. This must be witnessed by two people. If items are properly identified by the loved ones, using the *Victim Identification Form*, document who claimed them, the relationship to the deceased, the date and time they were released, and who witnessed them being removed.

7. **Viewings and Death Notifications:** In the absence of a coroner or law enforcement representative, the Incident Commander will need to designate someone to be responsible for authorizing and arranging viewings and making death notifications. Families need to know the fate of their loved ones. Timely, honest, and accurate information should be provided in a compassionate way. The need for families to view their loved ones should be honored as part of the grieving process.

However, viewings should not occur in the morgue while the morgue is actively receiving victims. If possible, wait until the rescue operations are complete and the morgue has been stabilized. The viewing should be arranged in a private area of the morgue, using partitions. Positive identification should be documented on the *Victim Identification Form*. Arrange for trained grief counselors (if available) to provide support to families.

BODY DISPOSITION

In a disaster situation, when medical professionals are not available to handle the timely disposition of bodies, here are three options to consider 1) Cold Storage, 2) Temporary Burial, and 3) Release to Family. Here are considerations for each of these options.

1. **Cold Storage:** Bodies should be kept refrigerated between 38°F and 42°F, which will help preserve them for 1 to 3 months. This is called “Cold Storage” and could be accomplished by using a refrigerated delivery truck or fixed refrigeration unit in a nearby business if power is available to maintain the required temperature. If using this type of “Cold Storage” option, after the body has been properly documented and wrapped, it can be moved to the cold storage unit. Without cold storage, decomposition begins within 12 to 48 hours. After a large Cascadia subduction zone earthquake and tsunami, this option probably will not be readily available; either due to the lack of the cold storage unit itself or due to the lack of power or fuel to maintain the temperature.
2. **Temporary Burial:** If cold storage is not available, you may construct temporary ground burials since the temperature underground is lower than at the surface, providing natural refrigeration. Ideally, burial should be 4 ½ feet deep and at least 650 feet from drinking water sources. Consider making individual burials for small number of bodies and trench burials for larger numbers. If a trench burial is chosen, lay bodies in one layer only, not on top of each other, and leave 1 ½ feet between bodies. Clearly mark each body.

H1. DBFD CERT MORGUE PROTOCOLS, CONTINUED

Mark and map the burial site. Draw a map which includes a description of the location of the burial site, as well as the positioning of each package of remains by their identifying number as they lie in the trench. Keep photographic records if feasible. Marking the burial site is important for several reasons: identifies the location of the graves; provides a place for loved ones to gather to grieve; discourages people from conducting other activities in that location; and supports the recovery phase of the disaster when bodies need to be removed for professional processing and disposition.

3. **Release to Family:** If a family insists on taking their deceased loved one and handling the remains themselves, try to be compassionate and understanding. Provide information about burial considerations and offer assistance. Consult with the highest-ranking government or emergency response official on site (if there are any) to determine conditions for the release of bodies to their families.

No matter which Body Disposition option is selected, be sure to document it on each *Victim Identification Form*.

DEMOBILIZATION

There are two parts to demobilization: the demobilization of morgue supplies and equipment, and demobilization of the team running the morgue.

1. **Morgue Demobilization:** When the morgue is no longer holding any bodies, and the likelihood of receiving bodies has passed, it should be closed, sanitized and returned to logistics for storage or another use. Keep in mind however, that in an extended disaster event, it is possible that additional deaths will occur over time due to exposure, lack of medications, infection, aftershocks, and possibly even bodies washing up from the tsunami. Because of this, you may determine it is best to leave the morgue in place rather than returning it for storage.
2. **Team Demobilization:** When the search and rescue operations are complete and the morgue unit has finished processing the victims and is not likely to receive any more victims, the Morgue Branch Director can gather with the morgue team away from the morgue and debrief. Have the team assess their physical needs, such as fatigue, hydration, and nutrition. Arrange to meet these needs. Remind the team of the importance of confidentiality. Affirm them for the significant work they accomplished. Due to the sensitive nature of morgue activities, take extra care to see to their emotional needs. Discuss self-care options. Arrange for daily debriefs and check-ins for psychological care.

H1. DBFD CERT MORGUE PROTOCOLS, CONTINUED

MORGUE SUPPLY KIT

Establish a “Morgue Kit” for your neighborhood in advance of a disaster so that you will have what you need to implement these procedures if needed. First, get a container to put everything in such as a lockable storage trunk and a lock, since this can double as the secure storage locker for personal belongings. Everything you need, except for a tent, should fit in a storage trunk like the one pictured. Here is a list of contents for processing 10 victims.



- **1 Storage Trunk & Lock**
- **Morgue Set-up Supplies:** 1 tent canopy (10' x 20'), 1 tarp (for floor of tent) 8 partitions (shower curtains, sheets, or tarps), rope & zip ties (to hang partitions), and lighting
- **Wrapping Supplies:** 10 blankets or sturdy sheets, 10 clear plastic bags (for personal effects), 20 contractor bags (or 10 body bags), roll of Visqueen, duct tape, and strips of cloth for wrapping.
- **Documentation:** 2 *Morgue Tracking Forms*, 10 *Victim Identification Forms*, and 10 *Wrist/Ankle Tags*
- **Office Supplies:** clipboards, pens, paper, sharpie, scissors, masking tape, etc.
- **Sanitation Supplies:** kleenex, hand sanitizer, hand wipes, wash cloths, garbage cans and buckets, & plastic liners
- **PPE:** medical gloves, masks, goggles, infection control gowns, shower caps
- **Water:** bottled water for worker hydration and for sanitation

Caution about Messaging: If your neighborhood is reluctant to prioritize the development of a disaster cache containing basics such as shelter, water, and medical supplies, talking with them about developing a morgue kit is probably not a good place to start. Many people do not understand the necessity of this and starting here could close them off from even wanting to prepare for the basics. Start with the basics: shelter, water, and medical supplies. Most people can get behind those items. When you consider all the supplies recommended for the morgue kit, teams will notice that these items are interchangeable with the basics and can easily be used to support shelter, water, and medical needs. The paperwork is the main thing truly specific to Morgue Protocols.

CONCLUSION

After a large Cascadia subduction zone earthquake and tsunami, communities are going to have to be flexible. Every situation is different. As with all CERT operations, modify these procedures based on the circumstances and resources available at the time, doing the best you can. This information is designed to empower you by broadening your understanding with concepts and strategies to handle the deceased during a catastrophic disaster. Applying these concepts will help teams attempt to deal with the dead in an organized, safe, and respectful manner.

H1. DBFD CERT MORGUE PROTOCOLS, CONTINUED

MORGUE TRACKING FORM

Morgue Location						
Community or Neighborhood Name/Description _____				City _____		State _____
Describe Location of Morgue: _____						
Date/Time of Morgue Mobilization:				Date/Time of Morgue Demobilization:		
Victim ID #	Time In:	Sex (circle one)	Presumed Identity or Description	Approx. Age (circle one)	Time Out	Disposition
001		Male Female Unknown		Child: 0-11 Youth: 12-17 Adult: 18-64 Senior: 65+		<input type="checkbox"/> Cold Storage <input type="checkbox"/> Temporary Burial <input type="checkbox"/> Released to:
002		Male Female Unknown		Child: 0-11 Youth: 12-17 Adult: 18-64 Senior: 65+		<input type="checkbox"/> Cold Storage <input type="checkbox"/> Temporary Burial <input type="checkbox"/> Released to:
003		Male Female Unknown		Child: 0-11 Youth: 12-17 Adult: 18-64 Senior: 65+		<input type="checkbox"/> Cold Storage <input type="checkbox"/> Temporary Burial <input type="checkbox"/> Released to:
004		Male Female Unknown		Child: 0-11 Youth: 12-17 Adult: 18-64 Senior: 65+		<input type="checkbox"/> Cold Storage <input type="checkbox"/> Temporary Burial <input type="checkbox"/> Released to:
005		Male Female Unknown		Child: 0-11 Youth: 12-17 Adult: 18-64 Senior: 65+		<input type="checkbox"/> Cold Storage <input type="checkbox"/> Temporary Burial <input type="checkbox"/> Released to:
006		Male Female Unknown		Child: 0-11 Youth: 12-17 Adult: 18-64 Senior: 65+		<input type="checkbox"/> Cold Storage <input type="checkbox"/> Temporary Burial <input type="checkbox"/> Released to:
007		Male Female Unknown		Child: 0-11 Youth: 12-17 Adult: 18-64 Senior: 65+		<input type="checkbox"/> Cold Storage <input type="checkbox"/> Temporary Burial <input type="checkbox"/> Released to:
008		Male Female Unknown		Child: 0-11 Youth: 12-17 Adult: 18-64 Senior: 65+		<input type="checkbox"/> Cold Storage <input type="checkbox"/> Temporary Burial <input type="checkbox"/> Released to:
009		Male Female Unknown		Child: 0-11 Youth: 12-17 Adult: 18-64 Senior: 65+		<input type="checkbox"/> Cold Storage <input type="checkbox"/> Temporary Burial <input type="checkbox"/> Released to:
010		Male Female Unknown		Child: 0-11 Youth: 12-17 Adult: 18-64 Senior: 65+		<input type="checkbox"/> Cold Storage <input type="checkbox"/> Temporary Burial <input type="checkbox"/> Released to:
Notes:						

H1. DBFD CERT MORGUE PROTOCOLS, CONTINUED

VICTIM IDENTIFICATION FORM			
IDENTITY OF VICTIM			
Assign a Tracking Number & Attach Wristband: # _____ (001, 002, 003, 004, etc.)	Received Time: _____ AM or PM Date: _____ (circle one)	<input type="checkbox"/> Body	<input type="checkbox"/> Body Part (describe)
Name of Victim: _____		Possible Identity: (explain reasons for hypothesis)	
Death Confirmation: <input type="checkbox"/> Search & Rescue Team: Completed "Head-tilt, Chin-lift" procedure 2 times <input type="checkbox"/> Morgue Team: Completed "Head-tilt, Chin-lift" procedure 2 times <input type="checkbox"/> Health Care Professional Confirmation (if available): No pulse, no breaths Name _____			
Identity Confirmed by: <input type="checkbox"/> Family _____ <input type="checkbox"/> Photo _____ <input type="checkbox"/> Friend/Neighbor _____			
<input type="checkbox"/> Male	Approx. Age: _____	Approx. Height: _____	Hair Color: _____
<input type="checkbox"/> Female		Approx. Weight: _____	Hair Length: _____
Description of Clothing: _____			
Description of Injuries: _____			
Describe where this body (body part) was found: _____			
PERSONAL BELONGINGS: Document all Personal Belongings: (jewelry, wrist watch, eye glasses, cell phone.)			
Name of people logging personal belongings: _____		&	Released?
Type of Item	1. _____	Description	1. _____ <input type="checkbox"/> Yes
	2. _____		2. _____ <input type="checkbox"/> Yes
	3. _____		3. _____ <input type="checkbox"/> Yes
	4. _____		4. _____ <input type="checkbox"/> Yes
	5. _____		5. _____ <input type="checkbox"/> Yes
Personal Items Released to:	Name(s): _____	Date: _____	
	Relationship to Victim: _____		
	Witnessed by: _____ & _____		
ADDITIONAL ACTIONS TAKEN			
Viewed by	Names: _____		Date: _____
	Relationship to Victim: _____		
	Authorized by: _____		
Death Notification	Who was Notified? _____		Date: _____
	Relationship to Victim: _____		
	Who made the Notification? _____		
Body Disposition	<input type="checkbox"/> Cold Storage	Describe Location: _____	
	<input type="checkbox"/> Temporary Burial		
	<input type="checkbox"/> Released to: _____	Relationship to Deceased: _____	
	Authorized by: _____		

H2. JOYCE MORTUARY PLAN

Joyce Area Command (Area Command #3) Mortuary Plan

The Joyce Operations Area Command includes the Joyce, Pillar Point and Indian Valley Micro-islands. A major destructive earthquake (Cascadia subduction zone earthquake) is expected to destroy the bridges across the Elwha River that connect the micro-island communities to county and state services. FEMA predicts the quake will devastate western Washington and prevent county and state response to the Operations Area Command for as long as 30 days.

Standard Fatality Management in Clallam County: In accordance with state law, fatalities in Clallam County are reported to the County. A coroner or coroner’s designee examines the body and determines if the person died of natural causes or foul play. In the event foul play is suspected, law enforcement is called upon to process the remains and surroundings as a crime scene. When county authorities release the remains, they are taken to a funeral home for preparation for burial/cremation and religious services. State law requires the body to be interred in a legally defined cemetery. Cremains may be interred or scattered.

This Special Fatality Management Plan for Joyce Operations Area Command is in effect only if Clallam County is unable to process mass casualties that occur in the Joyce Operations Area.

- THIS PLAN DOES NOT APPLY TO MASS CASUALTIES CAUSED BY INFECTIOUS DISEASES. ADDITIONAL TRAINING, EQUIPMENT AND GUIDANCE WILL BE REQUIRED FOR AN EPIDEMIC.
- THIS PLAN APPLIES TO THE DOCUMENTATION, COLLECTION, PHYSICAL IDENTIFICATION, PROCESSING AND TEMPORARY INTERMENT OF DEAD BODIES IN THE JOYCE OPERATIONS AREA.
- JOYCE OPERATIONS AREA COMMAND DOES NOT HAVE THE EQUIPMENT OR PERSONNEL TO EXTRACATE DEAD BODIES FROM LANDSLIDE OR TSUNAMI ZONES.
- JOYCE OPERATIONS AREA COMMAND HAS LIMITED CAPABILITY TO EXTRACATE DEAD BODIES FROM COLLAPSED BUILDINGS.

Joyce Operations Area Command will regard a mass fatality event as an event involving multiple fatalities that cannot be addressed by standard Clallam County fatality processing procedures within 4 days. Reasons may include but are not limited to the inability or failure of the county to examine, investigate, identify, remove/transport, process and/or inter the remains. Joyce Operational Area Command welcomes county assistance and/or supervision of mass fatality processing. In the event county assistance is unavailable, bodies will be handled in accordance with this plan. This plan conforms with the International Red Cross “Management of Dead Bodies: Field Manual for First Responders”, Geneva 2016.

H2. JOYCE MORTUARY PLAN, CONTINUED

1. Recovery and processing of dead bodies will conform as closely as possible with procedures called out in **International Red Cross “Management of Dead Bodies: Field Manual for First Responders”, Geneva 2016 (Printed in this book)**.
2. Fatalities are to be reported to Joyce Operations Area Command by families, JEPP, CCFPD#4, law enforcement or noted during MYN/CERT searches. Joyce Area Command will maintain THE fatality location list. Fatalities will be reported to CCEOC as required in the CEMP. Dead body recovery may not happen for several days.
3. Missing persons are to be reported to the Joyce Disaster Service Center at the Joyce Bible Church. This information will be coordinated with ARC reunification efforts.
4. In the event Clallam County is unable to supervise dead body recovery operations, within 4 days of the event, Joyce Operations Area Command will designate and secure the location of a morgue in the Joyce vicinity.
5. The Joyce Operations Area Command will organize and train a “JUST IN TIME” volunteer crew to perform recovery of human remains and transport them to the Joyce morgue. Supplies for the recovery crew are stored in the Mortuary Kit in the JEPP shipping container at JBC.
6. If possible, a Clallam County deputy coroner or law enforcement officer, acting as coroner, will accompany the recovery team to determine if bodies to be recovered are a result of a crime. If the law enforcement/coroner officer determines a crime occurred, they will supervise activities at the crime scene or leave the scene until qualified investigators arrive.
7. The safety of the recovery team is more important than the recovery mission.
8. In the event the county is unable to conduct dead body recovery operations within 4 days, the Joyce Operations Area Command will alert CCEOC, if possible, of the start of human remains recovery operations. Joyce Operations Area Command welcomes county assistance and/or supervision of mass fatality recovery.
9. In the event the remains are fragmented or are indistinguishable from animal tissue (wild animals or stock) the team will assume the remains are human and treat them and document them as such.
10. The recovery team is to recover each victim’s remains individually (DO NOT MIX REMAINS). The crew will assign a unique identifier code to each body and attach it to the body.
11. The recovery crew will photograph the scene, photograph the victim, document the identification of the victim (partial victim) if possible, the location of the body, circumstances of the death and condition of the remains. All photos must include the victim’s unique identifier code.

H2. JOYCE MORTUARY PLAN, CONTINUED

12. The recovery team is to secure the victim's possessions and place them in a plastic bag labeled with the victim's unique identifier code. The bag is to be taped to the body (remains).
13. The team is to use "Write in the rain notepaper" and stylus (in mortuary tote) to record victim's unique identifier code. The code is to be written on the body and sealed in a waterproof luggage tag (in mortuary tote) to be taped around the ankle or wrist of the victim.
14. The victim's body (remains) is to be wrapped in a sheet (floating row cover fabric or permeable fabric) secured with duct tape, zip ties or string around the head, neck, waist and feet and stored at the morgue.
15. Body parts are to be documented as a complete body and wrapped individually for future identification.
16. In the event bodies cannot be moved to Port Angeles for burial, Joyce Operations Area Command may identify a tract of land in the Joyce vicinity and contact the owner for permission to enter an MOU with CCFD#4 for a temporary cemetery. Detailed maps (citing reference points and measurements of the locations of graves and dead bodies) are to be maintained by Joyce Area Command for this cemetery.
17. Joyce Operations Area Command Logistics will identify a small backhoe/excavator operator and arrange an MOU with CCFPD#4 for digging mass graves. Joyce Operations Area Command must reserve fuel for this activity. Hand digging of graves may be required. State law requires dead bodies be interred in a cemetery. Families should be encouraged to inter family members in the mass grave. This will facilitate disinterment at a later date so the body can be more easily identified and released for burial at an authorized final resting place.
18. Mass graves are to be 6 feet by 50 feet by 2.5 feet deep. Corner stakes are to be placed at all 4 corners of each mass grave (or individual grave if necessary).
19. The Joyce Operations Area Command will inform CCEOC, if possible, that it will proceed with burial of remains prior to the start of interment operations.
20. Bodies (remains) are to be buried 1 foot apart alternating head to toe. A stake is to be placed at the head of each body and labeled with the unique identifier and name of the deceased (THIS IS MANDATORY).
21. Detailed records of the unique identifier, name (if known) and location of each body are to be maintained to assist authorities when disinterment occurs prior to movement to permanent cemetery.

H2. JOYCE MORTUARY PLAN, CONTINUED

BACKGROUND INFORMATION

The following information is presented by the National Institute of Health in the Jun 2006 paper “Mass Fatality Management After the Indian Ocean Earthquake and Tsunami: Case Studies in Thailand, Indonesia and Sri Lanka.”

Lack of national or local mass fatality plans further limited the quality and timeliness of response, as did the absence of practical field guidelines or an international agency providing technical support.¹

In Sri Lanka, most bodies were taken to local hospitals, which had an indirect health impact by disrupting the provision of medical assistance to survivors and threatening to close hospitals because of the smell of decomposition.¹

No single person or organization had a clear mandate to coordinate the process of collecting, identifying, and disposing of the dead, either nationally or locally. None of the countries had mass fatality plans.¹

¹ <http://www.ncbi.nlm.nih.gov/pmc/articles/PMC1472696/>

The following information is presented in the CNN Report by Madison Park “Where Bodies Go after Natural Disasters” dated January 16, 2010.

"Body collection is not the most urgent task after a natural disaster," according to the WHO's 2006 guidance on the Management of Dead Bodies after Disasters. "The priority is to care for survivors. There is no significant public health risk associated with the presence of bodies. Nevertheless, bodies should be collected as soon as possible and taken away for identification."²

Mass graves, it warranted, are "not justified on public health grounds. Rushing to dispose of bodies without proper identification traumatizes families and communities and may have serious legal consequences."²

Having bodies on the street is very distressing to survivors.²

"That's going to be very stressful," Ciaccio said. "It's hot temperatures and that's not a pleasant sight. There's decomposed bodies. And the hotter the weather, the quicker the decomposition."

Decomposition starts as early as the day of death, bringing stench and pests.

"When you have bodies on the street that begin to decompose, you eventually get maggot infestation because of flies and you have a potential of rats," said Vernie Fountain, the disaster task force leader of the National Funeral Directors Association.²

H2. JOYCE MORTUARY PLAN, CONTINUED

"What we often see are these pictures of mass graves which are dug three feet deep with hundreds of bodies thrown into this large hole," Morgan said. "That's discouraged in preference to having a more organized situation with a long trench grave and putting bodies in an ordered way, or marked graves so people know where the victims are buried."

One possible solution is to move the bodies to a temporary, organized collection point and to gather as much information to help with future identification, said Fountain, who served as a national officer for Disaster Mortuary Operational Response Team, a national response team designed to provide mortuary assistance in mass fatality incidents.²

² <http://www.cnn.com/2010/HEALTH/01/14/haiti.mass.fatalities.bodies/>

This following information is presented in the International Red Cross “Management of dead Bodies: Field Manual for First Responders,” Geneva 2016.

While none of the countries affected by the tsunami had enough refrigerated storage to handle the corpses, many found alternatives by burying the dead in temporary, shallow graves with the intent to exhume them later.³

³ <https://www.icrc.org/eng/assets/files/other/icrc-002-0880.pdf>

MORTUARY KIT

INVENTORY

COVERALLS, TYVEC – 12 EACH
 SAFETY GOGGLES – 6 EACH
 GLOVES, HEAVY (9 MIL) 1 BOX
 MASKS, SURGICAL – 9 EACH
 SHEETS, WHITE - 20 EACH
 TRASH BAGS, INDUSTRIAL – 1 ROLL
 TAPE, GORILLA - 1 ROLL
 TAPE, BARRIER/SCENE – 1 ROLL
 TAGS, BODY – 100 EACH
 PAPER, WRITE IN RAIN BOOKS – 2 EA
 INDELIBLE MARKERS – 2 EACH
 ICRC UNIQUE BODY TAGS – 60 EA
 ICRC DEAD BODY INFORMATION FORM (ANNEX A) – 20 EA

ADDITIONAL MATERIALS NEEDED FROM OTHER STOCK

IMPERMEABLE APRONS
 RUBBER BOOTS
 HAND SOAP/DISINFECTANT
 WET WIPES
 24” ZIP TIES
 TARPS
 BAGS, CARRIER WITH HANDLES
 BAGS, ZIPPERED PLASTIC EVIDENCE
 BAILING TWINE
 BAGS SHOPPING (FOR PERSONAL EFFECTS)
 DIGITAL CAMERA
 LAP TOP
 CLIP BOARD

APPENDIX I: RESOURCES & REFERENCES

Overview: This section features 1) a list of earthquake and tsunami disaster preparedness partner websites, 2) individual and community preparedness resources, 3) and references corresponding to the topics, concepts, and strategies discussed in the *Guide*.

EARTHQUAKE & TSUNAMI DISASTER PREPAREDNESS PARTNER WEBSITES

Additional information about various aspects of disaster preparedness that may relate to decisions about developing disaster caches can be found at these websites.

ORGANIZATION	WEBSITE
Oregon Tsunami Clearinghouse	www.oregontsunami.org
Oregon Department of Geology and Mineral Industries (DOGAMI)	www.oregongeology.org
National Tsunami Hazard Mitigation Program (NTHMP)	nws.weather.gov/nthmp/
U.S. Tsunami Warning System	www.tsunami.gov/
Cascadia Region Earthquake Workgroup (CREW)	crew.org/
National Earthquake Hazards Reduction Program (NEHRP)	www.nehrp.gov/
U.S. Geological Survey Earthquake Preparedness	www.usgs.gov/science-explorer-results?es=earthquake+preparedness
Incorporated Research Institutions for Seismology (IRIS)	www.iris.edu/hq/
Oregon Office of Emergency Management (OEM)	www.oregon.gov/oem
Community Emergency Response Team (CERT)	www.ready.gov/cert
Federal Emergency Management Agency (FEMA)	www.fema.gov/
Oregon Department of Land Conservation and Development (DLCD)	www.oregon.gov/lcd

INDIVIDUAL & COMMUNITY PREPAREDNESS RESOURCES

Visit Oregon's [2 Weeks Ready](http://www.oregon.gov/oem/hazardsprep/Pages/2-Weeks-Ready.aspx) website to find a variety of practical publications and videos to help individuals and communities prepare for an earthquake, tsunami, or other disaster: <https://www.oregon.gov/oem/hazardsprep/Pages/2-Weeks-Ready.aspx>. Several of the resources related to this *Planning Guide* are listed below.

- 2 Weeks Ready - Communications: Communicating During and After Emergencies, [English](#).
- 2 Weeks Ready - First Aid: Be Your Own First Responder, [English](#).
- 2 Weeks Ready - Food: Prepare Your Pantry, [English](#) or [Spanish](#).
- 2 Weeks Ready - Shelter: A Safe Place After a Disaster, [English](#).
- 2 Weeks Ready - Water: Prepare to Stay Hydrated, [English](#) or [Spanish](#).
- Living on Shaky Ground: How to survive earthquakes and tsunamis in Oregon, [English](#) or [Spanish](#).
- My Pocket Planner, [English](#) or [Spanish](#).
- Prepare! A Resource Guide, the American Red Cross, [English](#) or [Spanish](#).

REFERENCES

- American Red Cross. (2021). *Make a First Aid Kit*. www.redcross.org/get-help/how-to-prepare-for-emergencies/anatomy-of-a-first-aid-kit.html. Accessed May 2021.
- Centers for Disease Control and Prevention. (2021, January 11). *Emergency Drinking Water*, www.cdc.gov/healthywater/emergency/drinking. Accessed May 2021.
- Centers for Disease Control and Prevention. (2020, September 8). *Keep Food Safe After a Disaster or Emergency*. www.cdc.gov/foodsafety/keep-food-safe-after-emergency.html. Accessed May 2021.
- Centers for Disease Control and Prevention. (2021, March 16). *Rainwater Collection*. www.cdc.gov/healthywater/drinking/private/rainwater-collection.html. Accessed May 2021.
- Danielsson, M., & Lippincott, M. (2012). *A Sewer Catastrophe Companion - Dry Toilets for Wet Disasters*. Pacific Northwest College of Art and Portland Bureau of Emergency Management, Portland, Oregon, USA.
- Emergency Volunteer Corps of Nehalem Bay. (2021, May 16). *Food Planning: An Essential Element of Survival*. EVCNB. <https://evcnb.org/food-planning>. Accessed May 2021.
- Emergency Volunteer Corps of Nehalem Bay. (2021, May 16). *Water, Sanitation & Hygiene (WaSH)*. EVCNB. <https://evcnb.org/water-sanitation-hygiene>. Accessed May 2021.
- Federal Emergency Management Agency. (2004, August). *Food and Water in an Emergency*, [Brochure]. FEMA 477, A5055. www.fema.gov/pdf/library/f%26web.pdf. Accessed May 2021.
- FoodSafety.gov. (2021, May 12). *Food Safety in a Disaster or Emergency*. www.foodsafety.gov/keep-food-safe/food-safety-in-disaster-or-emergency. Accessed May 2021.
- Hahn, J., & Smith, M. (2010). *Pacific Coast Foraging Guide, 40 Wild Foods From Beach, Field, and Forest*. Skipstone. www.skipstonebooks.org.
- Jenkins, J. (2019). *Humanure Handbook*. Joseph Jenkins, Inc. <https://humanurehandbook.com>.
- Ready.gov. (2021, April 21). *Food*. www.ready.gov/food. Accessed May 2021.
- Ready.gov. (2021, May 4). *Prepare Your Pets for Disasters*. <https://www.ready.gov/pets#>. Accessed May 2021.
- Ready.gov. (2021, February 22). *Water*. www.ready.gov/water. Accessed May 2021.
- Regional Disaster Preparedness Organization of the Portland Metropolitan Region with funding from the U.S. Department of Homeland Security/Urban Areas Security Initiative (UASI) grant program. (2021). *Emergency Toilet Guidebook*. <https://rdpo.net/emergency-toilet>. Accessed May 2021.

Regional Water Providers Consortium. (2021). *Before There's an Emergency. Get Ready. Get Water.* <https://www.regionalh2o.org/emergency-preparedness>. Accessed May 2021.

REI Co-op. (2021). *How to Choose a Water Filter or Purifier.* www.rei.com/learn/expert-advice/water-treatment-backcountry. Accessed May 2021.

Seattle Emergency Communications Hubs. (2014). *Self Help Posters* [Posters]. <http://seattleemergencyhubs.org/blog/self-help-posters-now-available/>. Accessed May 2021.

USDA Forest Service. (2012). *Smokey Bear's Campfire Safety Guide* [Brochure]. <https://smokeybear.com/education/smokey-campfire-safety-checklist.pdf>. Accessed May 2021.

Wellington Region Emergency Management. (2021). *Hub Guide.* [Wellington Region Emergency Management Community Emergency Hub Program](#). Accessed May 2021.

**Oregon Department of Geology
and Mineral Industries**

www.oregongeology.org
www.OregonTsunami.org



Oregon Office of Emergency Management

www.oregon.gov/OEM

